



OFFICE Pro
Good People, Who Know



2023/2024

BUSINESS

PRODUCTS CATALOGUE

CHECK ONLINE FOR CURRENT PRICING



WHICH GLASS BOARD IS RIGHT FOR YOU?



What to consider when choosing a glass board: size, shape, type of surface, frame style, and price points.



INFINITY™ GLASS

A standard style glass board that mounts on your wall vertically or horizontally

YOU CHOOSE:

- The glass colour: magnetic white, magnetic black or frosted
- Customizable, or not customizable
- Sizes from 8.5" x 11" to 96" x 48"

IDEAL FOR:

- Office, education, healthcare settings, or at home use and private offices.

BRILLIANCE GLASS

A high-contrast, bright white magnetic glass board that may be vertically or horizontally mounted

YOU CHOOSE:

- The size: from 24" x 18" to 96" x 48"
- Also available in an exclusive 48" x 48" square size

IDEAL FOR:

- Office or at home use
- Anyone who wants a vivid white surface

INVISAMOUNT™ GLASS

Created for long-term heavy use, this wide-format magnetic glass board has invisible mounting hardware giving you an uninterrupted surface from edge to edge. It appears to float on your wall

YOU CHOOSE:

- The glass colour: black or white
- The size: from 39" x 22" up to 85" x 48"

IDEAL FOR:

- Executive office and conference rooms
- Healthcare settings due to edge-to-edge surface and no standoffs
- Anyone whose aesthetic is sleek and modern

All Quartet Glass Boards have this in common:

Durable, tempered, non-absorbent glass surfaces that won't stain or ghost and resists scratches and dents

So...Which Board is Right for You?

Armed with more information, you can choose the glass surface which is right for your needs.

2023/2024 Office Pro Catalogue

Technology	3-90
Business Machines	91-122
Office Supplies	123-352
Education & Art Supplies	353-400
Cleaning, Breakroom & Facilities	401-514
Furniture	515-615
Index	616-632

All prices listed in this catalogue are current at the time of printing.
For the most current price, please check online.

Provincial Sales Tax (PST) and Goods and Services Tax (GST)
or Harmonized Sales Tax (HST) are extra where applicable.
Environmental Fees may apply on electronics.

Delivery and/or Installation fees may apply.
Check with your local dealer for details.

While every effort has been taken to ensure the accuracy of the
information in this catalogue, some prices and specifications may
be subject to change.

*Proudly serving our communities
from coast to coast to coast.*



Since 1970, our dealers have been looking after the needs of our customers from British Columbia to Newfoundland to Nunavut. We know how to provide the right products, at the right price, at the right time. This 100% Canadian-owned and operated association of independent office products dealers have access to a growing selection of over 11,000 office products from more than 130 major manufacturers. From the latest technology, to a full line of office furniture and everyday office supplies, we can satisfy the stationery and office needs of any Canadian home or business. We also carry what you need in the back of your business; warehouse & shipping supplies, health & safety supplies, and cleaning & breakroom supplies.

Shop your way.

Order online, in person or over the phone.

We're here to help!

Technology

Backrests & Footrests.	66-67
Batteries.	73-75
Business Travel	34-41
Cables & Adapters.	76-80
Copyholders.	68
Electronic Cleaning.	69
Ink & Toner.	6-24
Keyboards & Trays	53-60
Data Storage.	42-46
Mice	47-52
Monitors & Accessories	61-65
Networking	81-82
Printers & Scanners	25-33
Speakers, Headphones & Earbuds.	85-87
Surge Protectors	70-72
Telephones & Voice Recorders	88-90
Webcams	83-84



ORIGINAL HP INK AND TONER CARTRIDGES

RELIABLE PRINTING
YOU CAN TRUST

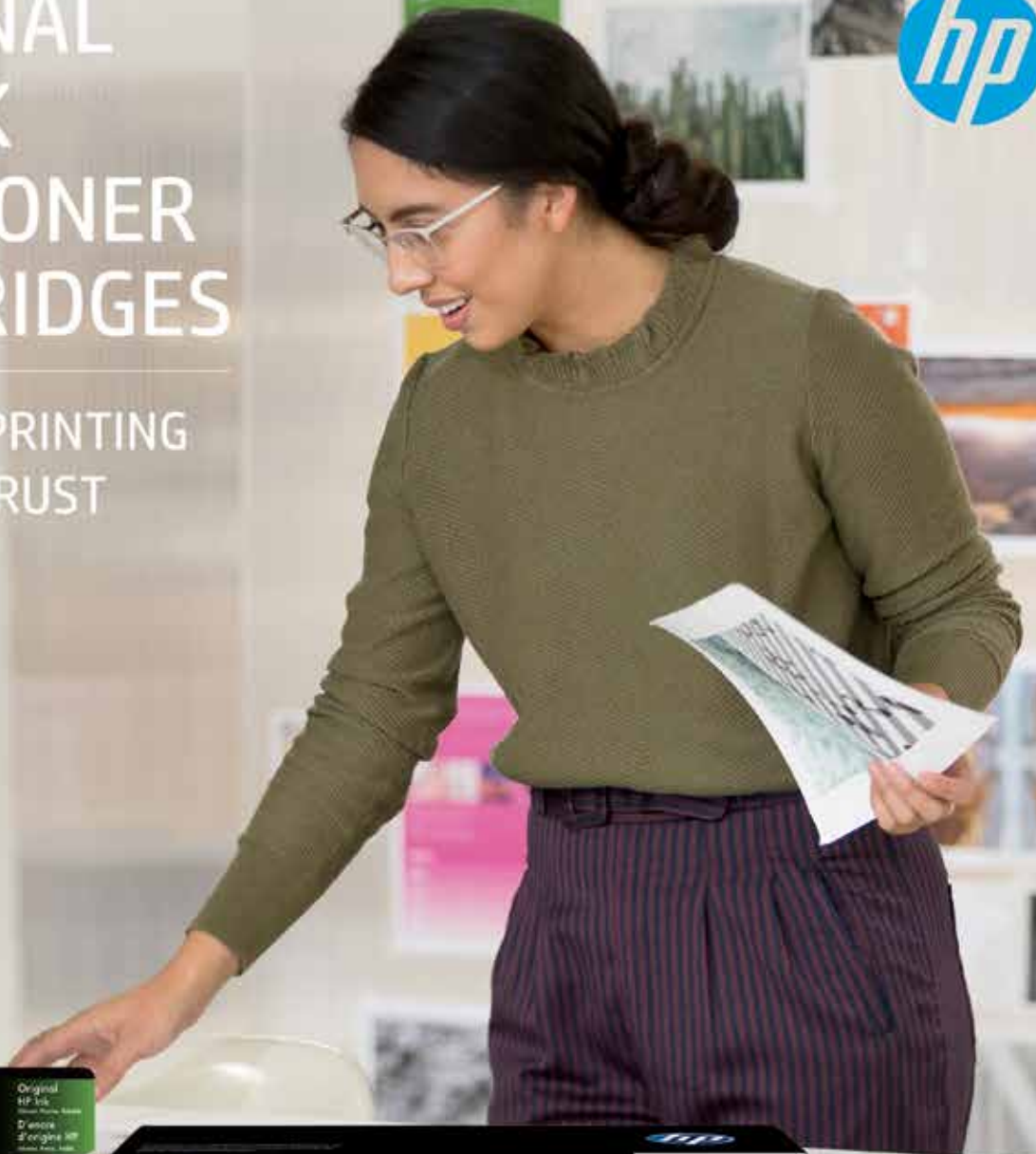



LOVE PRINTING AGAIN.

Sourced from top manufacturers around the world, and produced with the industry's finest components, chips and high-quality chemical toners and pigment inks, fuzion™ ensures worry-free quality and value. Affordable. Reliable. Zimple. FUZIONTONER.COM



fuzion™
affordable. reliable. zimple.

Ink and Toner Cartridges

PRODUCT NO.	CARTRIDGE NO.	COLOUR	MODEL	TYPE	YIELD
BROTHER® LASER CARTRIDGES					
TN330	TN330	Black	DCP7030 / DCP7040 / HL2140 / HL2170w / MFC7340 / MFC7440n / MFC7840w	Standard	1,500
TN360	TN360	Black		High yield	2,600
DR360	DR360	Black		Drum	12,000
TN580	TN580	Black	DCP8060 / DCP8065dn / HL5240 / HL5240I / HL5240It / HL5250dn / HL5250dnh / HL5250dnl / HL5250dnt / HL5280dw / HL5280dwt / MFC8460n / MFC8660dn / MFC8670dn	High yield	7,000
TN750	TN750	Black	DCP8110dn / DCP8150dn / DCP8155dn / HL5440d / HL5450dn / HL5450dnt / HL5470dw / HL5470dwt / HL6180dw / HL6180dwt / MFC8510dn / MFC8710dw / MFC8910dw / MFC8950dw / MFC8950dwt	High yield	8,000
TN630	TN630	Black	DCPL2520d / DCPL2520dw / DCPL2540dn / DCPL2540dw / HLL2300 / HLL2300d / HLL2305w / HLL2315dw / HLL2320d / HLL2340dw / HLL2360dn / HLL2360dw / HLL2380dw / MFCL2680w	Standard	1,200
TN660	TN660	Black		High yield	2,600
DR630	DR630	Black	DCPL2540dw / DCPL2520dw / HLL2360dw / HLL2320D / MFCL2740dw / MFCL2720dw / MFCL2700dw / HLL2380dw	Drum	12,000
TN730	TN730	Black	DCPL2550dn / DCPL2550dw / HLL2350dw / HLL2370dn / HLL2370dw / HLL2375dw / HLL2390dw / HLL2395dw / MFCL2710dn / MFCL2710dw / MFCL2750dw / MFCL2730dw	Standard	1,200
TN760	TN760	Black		High yield	3,000
DR730	DR730	Black	DCPL2550dw / HLL2370dw / HLL2390dw / HLL2395dw / MFCL2710dw / MFCL2730dw / MFCL2750dw	Drum	12,000
TN460	TN460	Black	FAX4100 / FAX4100e / FAX4750 / FAX4750e / MFC8500 / MFC8600 / FAX5750 / MFC8300 / MFC8700 / MFC9700 / MFC9800 / HL1030 / HL1240 / HL1240dx / HL1250 / HL1250dx / HL1270n / HL1230 / HL1435 / HL1440	High yield	6,000
DR400	DR400	Black		Drum	20,000
TN350	TN350	Black	HL2040 / HL2070n / MFC7220 / DCP7020 / MFC7420 / MFC7820n / FAX2820	Standard	2,500
TN420	TN420	Black	HL2230 / HL2240 / HL2240d / HL2270dw / DCP7060d / DCP7065dn / HL2280dw / MFC7360n / MFC7460dn / MFC7860dw	Standard	1,200
TN450	TN450	Black		High yield	2,600
DR420	DR420	Black		Drum	12,000
TN210BK	TN210BK	Black	HL3040cn / HL3040cw / HL3045cn / HL3070cw / HL3075cw / MFC9010cn / MFC9120cn / MFC9125cn / MFC9320cn / MFC9320cw / MFC9325cw	Standard	2,200
TN210C	TN210C	Cyan		Standard	1,400
TN210M	TN210M	Magenta		Standard	1,400
TN210Y	TN210Y	Yellow		Standard	1,400
TN221BK	TN221BK	Black	HL3140cw / HL3170cdw / HL3180cdw / MFC9130cw / MFC9330cdw / MFC9340cdw	Standard	2,500
TN221C	TN221C	Cyan		Standard	1,400
TN221M	TN221M	Magenta		Standard	1,400
TN221Y	TN221Y	Yellow		Standard	1,400
TN225C	TN225C	Cyan		High yield	2,200
TN225M	TN225M	Magenta		High yield	2,200
TN225Y	TN225Y	Yellow		High yield	2,200
DR221CL	DR221CL	Colour		Drum	15,000
TN310BK	TN310BK	Black	HL4150cdn / HL4570cdw / HL4570cdwt / MFC9460cdn / MFC9560cdw / MFC9970cdw	Standard	2,500
TN310C	TN310C	Cyan		Standard	1,500
TN310M	TN310M	Magenta		Standard	1,500
TN310Y	TN310Y	Yellow		Standard	1,500
TN315BK	TN315BK	Black		High yield	6,000
TN315C	TN315C	Cyan		High yield	3,500
TN315M	TN315M	Magenta		High yield	3,500
TN315Y	TN315Y	Yellow		High yield	3,500
TN620	TN620	Black	HL5370dw / MFC8480dn / MFC8890dw / DCP8080dn	Standard	3,000
TN650	TN650	Black		High yield	8,000
DR620	DR620	Black		Drum	25,000
TN720	TN720	Black	HL5450dn / HL5470dw / HL6180dw / MFC8510dn / MFC8710dw / MFC8910dw / MFC8950dw	Standard	3,000
DR720	DR720	Black		Drum	30,000
TN223BK	TN223BK	Black	HLL3210cw / HLL3230cdw / HLL3270cdw / HLL3290cdw / MFCL3710cw / MFCL3750cdw and MFCL3770cdw	Standard	1,400
TN223C	TN223C	Cyan		Standard	1,300
TN223M	TN223M	Magenta		Standard	1,300
TN223Y	TN223Y	Yellow		Standard	1,300
TN227BK	TN227BK	Black		High yield	3,000
TN227C	TN227C	Cyan		High yield	2,300
TN227M	TN227M	Magenta		High yield	2,300
TN227Y	TN227Y	Yellow		High yield	2,300

PRODUCT NO.	CARTRIDGE NO.	COLOUR	MODEL	TYPE	YIELD	
BROTHER® LASER CARTRIDGES (continued)						
TN820	TN820	Black	HLL5000d / HLL5200dw / HLL6200dw / MFCL5700dw / MFCL5800dw / MFCL5900dw / MFCL6700dw / HLL6400dw / MFCL6900dw	Standard	3,000	
TN850	TN850	Black		High yield	8,000	
DR820	DR820	Black		Drum	30,000	
TN880	TN880	Black	HLL6200dw / MFCL6700dw / HLL6400dw / MFCL6900dw	Super high yield	12,000	
TN433BK	TN433BK	Black	HLL8260cdw / HLL8360cdw / HLL8360cdwmt / HLL8360cdwt / MFCL8610cdw / MFCL8900cdw / MFCL9570cdw	High yield	4,500	
TN433C	TN433C	Cyan		High yield	4,000	
TN433M	TN433M	Magenta		High yield	4,000	
TN433Y	TN433Y	Yellow		High yield	4,000	
TN436BK	TN436BK	Black		Super high yield	6,500	
TN436C	TN436C	Cyan		Super high yield	6,500	
TN436M	TN436M	Magenta		Super high yield	6,500	
TN436Y	TN436Y	Yellow		Super high yield	6,500	
TN331BK	TN331BK	Black		HLL8350cdn / MFCL8600cdn / MFCL8850cdw	Standard	2,500
TN331C	TN331C	Cyan	Standard		1,500	
TN331M	TN331M	Magenta	Standard		1,500	
TN331Y	TN331Y	Yellow	Standard		1,500	
TN336BK	TN336BK	Black	High yield		4,000	
TN336C	TN336C	Cyan	High yield		3,500	
TN336M	TN336M	Magenta	High yield		3,500	
TN336Y	TN336Y	Yellow	High yield		3,500	
DR331CL	DR331CL	Colour	Drum		25,000	
TN431BK	TN431BK	Black	HLL8360cdw / MFCL8610cdw / MFCL8900cdw		Standard	3,000
TN431C	TN431C	Cyan			Standard	1,800
TN431M	TN431M	Magenta			Standard	1,800
TN431Y	TN431Y	Yellow		Standard	1,800	
DR431CL	DR431CL	Colour		Drum	30,000	
TN339BK	TN339BK	Black		HLL9200cdw / HLL9200cdwt / HLL9300cdwt / MFCL9550cdw / MFCL9550cdwt	Super high yield	6,000
TN339C	TN339C	Cyan	Super high yield		6,000	
TN339M	TN339M	Magenta	Super high yield		6,000	
TN339Y	TN339Y	Yellow	Super high yield		6,000	
BROTHER® INKJET CARTRIDGES						
LC61BKS	LC61BKS	Black	DCPJ125 / MFC290c / MFC295cn / MFC490cw / MFC495cw / MFC5490cn / MFC5890cn / MFC6490cw / MFC795cw / MFCJ265w / MFCJ615w	Standard	450	
LC612PKS	LC612PKS	Black Twin Pack		Standard	450	
LC61CS	LC61CS	Cyan		Standard	325	
LC61MS	LC61MS	Magenta		Standard	325	
LC61YS	LC61YS	Yellow		Standard	325	
LC613PKS	LC613PKS	Cyan / Magenta / Yellow		Standard	325	
LC103BKS	LC103BKS	Black	DCPJ152w / DCPJ4110 / MFCJ4310 / MFCJ4610dw / MFCJ4710dw / MFCJ6520 / MFCJ6720 / MFCJ6920	High yield	600	
LC1032PKS	LC1032PKS	Black Twin Pack		High yield	600	
LC103CS	LC103CS	Cyan		High yield	600	
LC103MS	LC103MS	Magenta		High yield	600	
LC103YS	LC103YS	Yellow		High yield	600	
LC1033PKS	LC1033PKS	Cyan / Magenta / Yellow		High yield	600	
LC101BKS	LC101BKS	Black	DCPJ152w / MFCJ245 / MFCJ285dw / MFCJ450dw / MFCJ470dw / MFCJ650dw / MFCJ870dw / MFCJ875dw	Standard	300	
LC101CS	LC101CS	Cyan		Standard	300	
LC101MS	LC101MS	Magenta		Standard	300	
LC101YS	LC101YS	Yellow		Standard	300	
LC107BKS	LC107BKS	Black	DCPJ4110dw / MFCJ4310dw / MFCJ4410dw / MFCJ4510dw / MFCJ4310dw / MFCJ4710dw / MFCJ6520dw / MFCJ6720dw / MFC6920dw	Super high yield	1,200	
LC1053PKS	LC1053PKS	Cyan / Magenta / Yellow		Super high yield	1,200	
LC105CS	LC105CS	Cyan		Super high yield	1,200	
LC105MS	LC105MS	Magenta		Super high yield	1,200	
LC105YS	LC105YS	Yellow		Super high yield	1,200	

Ink and Toner Cartridges

PRODUCT NO.	CARTRIDGE NO.	COLOUR	MODEL	TYPE	YIELD	
BROTHER® INKJET CARTRIDGES (continued)						
LC71BKS	LC71BKS	Black	DCPJ525w / DCPJ725dw / DCPJ925dw / MFCJ280w / MFCJ425w / MFCJ430w / MFCJ435w / MFCJ625w / MFCJ825dw / MFCJ835dw	Standard	300	
LC71CS	LC71CS	Cyan		Standard	300	
LC71MS	LC71MS	Magenta		Standard	300	
LC71YS	LC71YS	Yellow		Standard	300	
LC713PKS	LC713PKS	Cyan / Magenta / Yellow		Standard	300	
LC75BKS	LC75BKS	Black		High yield	600	
LC752PKS	LC752PKS	Black Twin Pack		High yield	600	
LC75CS	LC75CS	Cyan		High yield	600	
LC75MS	LC75MS	Magenta		High yield	600	
LC75YS	LC75YS	Yellow		High yield	600	
LC753PKS	LC753PKS	Cyan / Magenta / Yellow		High yield	600	
LC51BKS	LC51BKS	Black	MFC2480c / DCP130c / DCP330c / DCP540cn / MFC230c / MFC240c / MFC3360c / MFC440cn / MFC465cn / MFC5460cn / MFC665cw / MFC685cw	Standard	500	
LC512PKS	LC512PKS	Black Twin Pack		Standard	450	
LC51CS	LC51CS	Cyan		Standard	500	
LC51MS	LC51MS	Magenta		Standard	500	
LC51YS	LC51YS	Yellow		Standard	500	
LC513PKS	LC513PKS	Cyan / Magenta / Yellow		Standard	400	
LC65HYBKS	LC65HYBKS	Black	MFC5890cn / MFC6490cw / MFC6890cdw	High yield	900	
LC65HYCS	LC65HYCS	Cyan		High yield	750	
LC65HYMS	LC65HYMS	Magenta		High yield	750	
LC65HYYS	LC65HYYS	Yellow		High yield	750	
LC401BKS	LC401BKS	Black	MFCJ1010dw / MFCJ1012dw / MFCJ1170dw	Standard	200	
LC401CS	LC401CS	Cyan		Standard	200	
LC401MS	LC401MS	Magenta		Standard	200	
LC401YS	LC401YS	Yellow		Standard	200	
LC4013PKS	LC4013PKS	Cyan / Magenta / Yellow		Standard	200	
LC401XLBKS	LC401XLBKS	Black		High yield	500	
LC401XLCS	LC401XLCS	Cyan		High yield	500	
LC401XLMS	LC401XLMS	Magenta		High yield	500	
LC401XLYS	LC401XLYS	Yellow		High yield	500	
LC401XL2PKS	LC401XL2PKS	Black Twin Pack		High yield	500	
LC401XL3PKS	LC401XL3PKS	Cyan / Magenta / Yellow		High yield	500	
LC207BKS	LC207BKS	Black		MFCJ4320dw / MFCJ4420dw / MFCJ4620dw	Super high yield	1,200
LC205CS	LC205CS	Cyan			Super high yield	1,200
LC205MS	LC205MS	Magenta			Super high yield	1,200
LC205YS	LC205YS	Yellow			Super high yield	1,200
LC2053PKS	LC2053PKS	Cyan / Magenta / Yellow			Super high yield	1,200
LC203BKS	LC203BKS	Black		MFCJ4320dw / MFCJ4420dw / MFCJ4620dw / MFCJ5620dw / MFCJ480dw / MFCJ4850dw / MFCJ680dw / MFCJ885dw	High yield	550
LC2032PKS	LC2032PKS	Black Twin Pack	High yield		550	
LC203CS	LC203CS	Cyan	High yield		600	
LC203MS	LC203MS	Magenta	High yield		600	
LC203YS	LC203YS	Yellow	High yield		600	
LC2033PKS	LC2033PKS	Cyan / Magenta / Yellow	High yield		550	

PRODUCT NO.	CARTRIDGE NO.	COLOUR	MODEL	TYPE	YIELD
BROTHER® INKJET CARTRIDGES (continued)					
LC406BKS	LC406BKS	Black	MFCJ4334dw / MFCJ4345dw	Standard	3,000
LC406CS	LC406CS	Cyan		Standard	1,500
LC406MS	LC406MS	Magenta		Standard	1,500
LC406YS	LC406YS	Yellow		Standard	1,500
LC4063PKS	LC4063PKS	Cyan / Magenta / Yellow		Standard	1,500
LC406XLBKS	LC406XLBKS	Black		High yield	6,000
LC406XLCS	LC406XLCS	Cyan		High yield	5,000
LC406XLMS	LC406XLMS	Magenta		High yield	5,000
LC406XLYS	LC406XLYS	Yellow		High yield	5,000
LC201BKS	LC201BKS	Black	MFCJ480dw / MFCJ485dw / MFCJ680dw / MFCJ885dw	Standard	260
LC201CS	LC201CS	Cyan		Standard	260
LC201MS	LC201MS	Magenta		Standard	260
LC201YS	LC201YS	Yellow		Standard	260
LC2013PKS	LC2013PKS	Cyan / Magenta / Yellow		Standard	260
LC3011BKS	LC3011BKS	Black	MFCJ491dw / MFCJ497dw / MFCJ690dw	Standard	200
LC30112PKS	LC30112PKS	Black Twin Pack		Standard	200
LC3011CS	LC3011CS	Cyan		Standard	200
LC3011MS	LC3011MS	Magenta		Standard	200
LC3011YS	LC3011YS	Yellow		Standard	200
LC30113PKS	LC30113PKS	Cyan / Magenta / Yellow		Standard	200
LC3013BKS	LC3013BKS	Black		High yield	400
LC30132PKS	LC30132PKS	Black Twin Pack		High yield	400
LC3013CS	LC3013CS	Cyan		High yield	400
LC3013MS	LC3013MS	Magenta		High yield	400
LC3013YS	LC3013YS	Yellow		High yield	400
LC30133PKS	LC30133PKS	Cyan / Magenta / Yellow		High yield	400
LC3019BKS	LC3019BKS	Black		MFCJ5330dw / MFCJ6530dw / MFCJ6730dw / MFCJ6930dw	Super high yield
LC30192PKS	LC30192PKS	Black Twin Pack	Super high yield		3,000
LC3019CS	LC3019CS	Cyan	Super high yield		1,500
LC3019MS	LC3019MS	Magenta	Super high yield		1,500
LC3019YS	LC3019YS	Yellow	Super high yield		1,500
LC30193PKS	LC30193PKS	Cyan / Magenta / Yellow	Super high yield		1,500
LC3017BKS	LC3017BKS	Black	MFCJ5330dw / MFCJ6530dw / MFCJ6930dw	High yield	550
LC30172PKS	LC30172PKS	Black Twin Pack		High yield	550
LC3017CS	LC3017CS	Cyan		High yield	550
LC3017MS	LC3017MS	Magenta		High yield	550
LC3017YS	LC3017YS	Yellow		High yield	550
LC30173PKS	LC30173PKS	Cyan / Magenta / Yellow		High yield	550
LC3029BKS	LC3029BKS	Black	MFCJ5830dw / MFCJ6535dw	Super high yield	3,000
LC30292PKS	LC30292PKS	Black Twin Pack		Super high yield	3,000
LC3029CS	LC3029CS	Cyan		Super high yield	1,500
LC3029MS	LC3029MS	Magenta		Super high yield	1,500
LC3029YS	LC3029YS	Yellow		Super high yield	1,500
LC30293PKS	LC30293PKS	Cyan / Magenta / Yellow		Super high yield	1,500

Ink and Toner Cartridges

PRODUCT NO.	CARTRIDGE NO.	COLOUR	MODEL	TYPE	YIELD
BROTHER® INKJET CARTRIDGES (continued)					
LC3037BKS	LC3037BKS	Black	MFCJ5845dw / MFCJ5945dw / MFCJ6545dw / MFCJ6945dw	Super high yield	3,000
LC3037CS	LC3037CS	Cyan		Super high yield	1,500
LC3037MS	LC3037MS	Magenta		Super high yield	1,500
LC3037YS	LC3037YS	Yellow		Super high yield	1,500
LC30373PKS	LC30373PKS	Cyan / Magenta / Yellow		Super high yield	1,500
LC3039BKS	LC3039BKS	Black		Ultra high yield	6,000
LC3039CS	LC3039CS	Cyan		Ultra high yield	5,000
LC3039MS	LC3039MS	Magenta		Ultra high yield	5,000
LC3039YS	LC3039YS	Yellow		Ultra high yield	5,000
LC79BKS	LC79BKS	Black	MFCJ5910dw / MFCJ6510dw / MFCJ6710dw / MFCJ6910dw	Super high yield	2,400
LC79CS	LC79CS	Cyan		Super high yield	1,200
LC79MS	LC79MS	Magenta		Super high yield	1,200
LC79YS	LC79YS	Yellow		Super high yield	1,200
LC793PKS	LC793PKS	Cyan / Magenta / Yellow		Super high yield	1,200
LC20EBKS	LC20EBKS	Black	MFCJ5920dw / MFCJ775dw / MFCJ775dwxl / MFCJ985dw	Super high yield	2,400
LC20ECS	LC20ECS	Cyan		Super high yield	1,200
LC20EMS	LC20EMS	Magenta		Super high yield	1,200
LC20EYS	LC20EYS	Yellow		Super high yield	1,200
LC109BKS	LC109BKS	Black	MFCJ6520dw / MFCJ6720dw / MFCJ6920dw	Super high yield	2,400
LC3033BKS	LC3033BKS	Black	MFCJ995dw / MFCJ995dwxl	Super high yield	3,000
LC3033CS	LC3033CS	Cyan		Super high yield	1,500
LC3033MS	LC3033MS	Magenta		Super high yield	1,500
LC3033YS	LC3033YS	Yellow		Super high yield	1,500
LC30333PKS	LC30333PKS	Cyan / Magenta / Yellow		Super high yield	1,500
LC3035BKS	LC3035BKS	Black		Ultra high yield	6,000
LC3035CS	LC3035CS	Cyan		Ultra high yield	5,000
LC3035MS	LC3035MS	Magenta		Ultra high yield	5,000
LC3035YS	LC3035YS	Yellow		Ultra high yield	5,000
CANON® LASER CARTRIDGES					
3252C001	121	Black	imageCLASS D1650	Standard	5,000
3500B001	128	Black	D550 imageCLASS / L100 Faxphone / L190 Fax / D530 imageCLASS / D560 imageCLASS / MF4450 imageCLASS / MF4570 imageCLASS / MF4570dn imageCLASS / MF4570dw imageCLASS / MF4770n imageCLASS / MF4880dw imageCLASS / MF4890dw imageCLASS	Standard	2,100
2617B001	120	Black	imageCLASS D1120 / D1150 / D1170 / D1180	Standard	5,000
9435B001	137	Black	ImageCLASS LBP151dw / MF212w / MF216n / MF217w / MF227dw / MF229dw / MF232w / MF236N / MF244dw / MF247dw / MF249dw	Standard	2,400
2168C001	051	Black	ImageCLASS LBP162dw / MF264dw / MF267dw / MF269dw	Standard	1,700
2169C001	051H	Black		High yield	4,100
3479B001	119	Black	ImageCLASS LBP251dw / MF414dw / MF5950dw / MF5960dn / MF6160dw / MF6180dw	Standard	2,100
3480B001	119 II	Black	ImageCLASS LBP251dw / MF414dw / MF6160dw	High yield	6,400
3484B001	125	Black	ImageCLASS MF3010	Standard	1,600
8489A001	X25	Black	ImageCLASS MF3110 / MF3240 / MF5730 / MF5750 / MF5770	Standard	2,500
3024C001	054	Black	ImageCLASS MF642Cdw	Standard	1,500
3023C001	054	Cyan		Standard	1,200
3022C001	054	Magenta		Standard	1,200
3021C001	054	Yellow		Standard	1,200
6272B001	131	Black	ImageCLASS MF8280Cw	Standard	1,400
6273B001	131	Black		High yield	2,400
6271B001	131	Cyan		Standard	1,500
6270B001	131	Magenta		Standard	1,500
6269B001	131	Yellow		Standard	1,500
0263B001	104	Black		L100 Faxphone / L120 Faxphone / L90 Faxphone / D420 imageCLASS / D480 imageCLASS / I-Sensys 4120 / I-Sensys 4140 / I-Sensys 4150 / L90 / MF4120 / Canon Satera / MF4130 Canon Satera / MF4150 imageCLASS / MF4150c imageCLASS / MF4270 imageCLASS / MF49600 / MFC9650 / MFC9660 / MFC9700 / MFC9750 / MFC9760 / MFC9800 / MFC9860 / MFC9880	Standard

Ink and Toner Cartridges

PRODUCT NO.	CARTRIDGE NO.	COLOUR	MODEL	TYPE	YIELD
CANON® INKJET CARTRIDGES					
3115B001	KP108IN		CP100 / CP200 / CP220 / CP300 / CP330 / Selphy CP100 / CP200 / CP220 / CP300 / CP333 / CP400 / CP510 / CP600 / CP710 / CP720 / CP730 / CP740 / CP760 / CP770 / CP780 / CP790 / CP800 / CP810 / CP820 / CP900 / CP910	Paper & Ink Kit	108
PGI1200BK	1200	Black	MAXIFY MB2020 / MB2120 / MB2320 / MB2720	Standard	400
PGI1200C	1200	Cyan		Standard	340
PGI1200M	1200	Magenta		Standard	340
PGI1200Y	1200	Yellow		Standard	340
9183B008	1200XL	Black / Cyan / Magenta / Yellow		High yield	935 Black, Colour
PGI1200XLBK	1200XL	Black		High yield	1,200
PGI1200XLC	1200XL	Cyan		High yield	900
PGI1200XLM	1200XL	Magenta		High yield	900
PGI1200XLY	1200XL	Yellow		High yield	900
CLI221BK	221	Black		PIXMA iP3600 / iP4600 / iP4700 / MP560 / MP630 / MP980 / MP990 / MX860 / MX870	Standard
CLI221C	221	Cyan	Standard		530
CLI221M	221	Magenta	Standard		510
CLI221Y	221	Yellow	Standard		530
PGI35BK	35	Black	PIXMA iP100	Standard	200
PG40	40	Black	PIXMA iP1200 / iP1300 / iP1600 / iP1700 / iP1800 / iP1900 / iP2200 / iP2500 / iP2600 / MP140 / MP150 / MP160 / MP170 / MP180 / MP190 / MP210 / MP220 / MP450 / MP460 / MP470 / MX300 / MX310	Standard	490
CL41	41	Colour		Standard	310
PG210	210	Black	PIXMA iP2700 / MP240 / MP250 / MP280 / MP480 / MP490 / MP495 / MX320 / MX330 / MX340 / MX350 / MX360 / MX410 / MX420	Standard	220
PG210XL	210XL	Black		High yield	400
2973B019	210XL / 211XL	Black / Colour		High yield	349
CL211	211	Colour		Standard	244
CL211XL	211XL	Colour		High yield	349
PGI5	5	Black		PIXMA iP3300 / iP3500 / iP4200 / iP4300 / iP5200 / iP5200R / MP500 / MP510 / MP520 / MP530 / MP600 / MP800 / MP950 / MX700 / MX850	Standard
PGI220	220	Black	PIXMA iP3600 / iP4600 / iP4700 / MP540 / MP560 / MP620 / MP640 / MP980 / MP990 / MX860 / MX870	Standard	350
CLI8BK	8	Black	PIXMA ip4200 / ip4300 / ip5200 Series / ip6600D / ip6700D / Pro9000 / MP500 / MP530 / MP600 / MP800 / MP830 / MP950 / MX850	Standard	420
CLI8C	8	Cyan		Standard	420
CLI8M	8	Magenta		Standard	420
CLI8PC	8	Photo Cyan		Standard	420
CLI8PM	8	Photo Magenta		Standard	420
CLI8Y	8	Yellow		Standard	420
4546B008	226	Black / Cyan / Magenta / Yellow	PIXMA iP4820 / ix6520 / MG5120 / MG5220 / MG6120 / MG8120 / MX882	Standard	450 Black, 510 Colour
CLI226BK	226	Black		Standard	450
CLI226C	226	Cyan		Standard	510
CLI226GY	226	Grey		Standard	510
CLI226M	226	Magenta		Standard	510
CLI226Y	226	Yellow		Standard	510
PGI225	225	Black	PIXMA iP4820 / MG5220 / MG5320 / MG6120 / MG6220 / MG8120 / MX882 / MX892	Standard	300
6497B009	250 / 251	Black / Cyan / Magenta / Yellow	PIXMA iP7220 / iP8720 / IX6820 / MG5420 / MG5520 / MG5522 / MG5620 / MG5622 / MG6320 / MG6420 / MG6620 / MG7120 / MG7520 / MX722 / MX922	Standard	300 Black, 300 Colour
PGI250	250	Black		Standard	300
PGI250XL	250XL	Black		High yield	500
6513B009	251	Black / Cyan / Magenta / Yellow		Standard	1,105 Black, 300 Colour
CLI251C	251	Cyan		Standard	300
CLI251GY	251	Grey		Standard	300
CLI251M	251	Magenta		Standard	300
CLI251Y	251	Yellow		Standard	300
CLI251XLB	251XL	Black		High yield	1,000
CLI251XLC	251XL	Cyan		High yield	650
CLI251XLY	251XL	Yellow		High yield	650
CLI251XLM	251XL	Magenta		High yield	650
CLI251XLY	251XL	Yellow		High yield	650

Ink and Toner Cartridges

PRODUCT NO.	CARTRIDGE NO.	COLOUR	MODEL	TYPE	YIELD	
CANON® INKJET CARTRIDGES (continued)						
PG240	240	Black	PIXMA MG2120 / MG2220 / MG3120 / MG3220 / MG3520 / MG3620 / MG4120 / MG4220 / MX372 / MX432 / MX452 / MX472 / MX512 / MX522 / MX532	Standard	180	
PG240XL	240XL	Black		High yield	300	
PG240XXL	240XXL	Black		Super high yield	600	
CL241	241	Colour		Standard	180	
CL241XL	241XL	Colour		High yield	400	
5206B020	240XL / 241XL	Black / Colour		High yield	300 Black, 400 Colour	
8278B006	245 / 246	Black / Colour	PIXMA iP2820 / MG2420 / MG2520 / MG2522 / MG2525 / MG2920 / MG2922 / MG2924 / MG3020 / MG3029 / MG6820 / MX490 / MX492 / TR4520 / TS202 / TS302 / TS3120	Standard	300	
PG245	245	Black		Standard	180	
PG245XL	245XL	Black		High yield	300	
CL246	246	Colour		Standard	180	
CL246XL	246XL	Colour		High yield	300	
PG243	243	Black		PIXMA MG2522 / MG2525 / MG3020 / TR4520 / TR4527 / TS202 / TS302 / TS3120	Standard	180
CL244	244	Colour	Standard		100	
PGI270	270	Black	PIXMA MG5720 / MG5721 / MG5722 / MG6820 / MG6821 / MG6822 / MG7720 / TS5020 / TS6020 / TS9020	Standard	300	
PGI270XL	270XL	Black		High yield	500	
0390C006	271	Black / Cyan / Magenta / Yellow		Standard	270	
CLI271BK	271	Black		Standard	1,795	
CLI271C	271	Cyan		Standard	345	
CLI271M	271	Magenta		Standard	345	
CLI271Y	271	Yellow		Standard	345	
CLI271XLBK	271XL	Black		High yield	4,425	
CLI271XLC	271XL	Cyan		High yield	650	
CLI271XLM	271XL	Magenta		High yield	650	
CLI271XLY	271XL	Yellow		High yield	650	
CLI36	36	Colour		PIXMA Mini260Canon / Mini360Canon / iP100 Mobile / Mini320 / iP100 / iP100wb	Standard	249
CLI42BK	42	Black		PIXMA Pro-100	Standard	800
CLI42C	42	Cyan			Standard	800
CLI42GY	42	Grey			Standard	480
CLI42LGY	42	Light Grey			Standard	111
CLI42M	42	Magenta	Standard		800	
CLI42PC	42	Photo Cyan	Standard		269	
CLI42PM	42	Photo Magenta	Standard		169	
CLI42Y	42	Yellow	Standard		800	
PG275	275	Black	PIXMA TR4720		Standard	100
CL276	276	Colour			Standard	100
PG275XL	275XL	Black		High yield	300	
CL276XL	276XL	Colour		High yield	300	
PGI280	280	Black	PIXMA TR7520 / TR7620 / TR8520 / TS6120 / TS8120 / TS9120 / TS9520	Standard	250	
PGI280XL	280XL	Black		High yield	500	
CLI281BK	281	Black		Standard	230	
CLI281C	281	Cyan		Standard	259	
CLI281M	281	Magenta		Standard	259	
CLI281Y	281	Yellow		Standard	259	
CLI281XLBK	281XL	Black		High yield	600	
CLI281XLC	281XL	Cyan		High yield	519	
CLI281XLM	281XL	Magenta		High yield	519	
CLI281XLY	281XL	Yellow		High yield	519	
PG260	260	Black		PIXMA TS5320	Standard	180
PG260XL	260XL	Black			High yield	400
CL261	261	Colour	Standard		180	
CL261XL	261XL	Colour	High yield		300	
3706C008	260XL / 261XL	Black / Colour	High yield		400 Black, 300 Colour	

PRODUCT NO.	CARTRIDGE NO.	COLOUR	MODEL	TYPE	YIELD
EPSON® INKJET CARTRIDGES					
T098120S	98	Black	Artisan 700 / 710 / 725 / 730 / 800 / 810 / 835 / 837	Standard	545
T099220S	99	Cyan		Standard	500
T099320S	99	Magenta		Standard	500
T099420S	99	Yellow		Standard	500
T099520S	99	Cyan		Standard	500
T099620S	99	Light Magenta		Standard	500
T099920S	99	Cyan / Light Cyan / Magenta / Light Magenta / Yellow		Standard	500
T079120	79	Black	Artisan 1430; Stylus Photo 1400	Standard	470
T079220	79	Cyan		Standard	810
T079320	79	Magenta		Standard	810
T079420	79	Yellow		Standard	810
T079520	79	Light Cyan		Standard	810
T079620	79	Light Magenta		Standard	810
T200120S	200	Black	Expression Home XP200 / XP300 / XP310 / XP400 / XP410; Workforce WF2010f / WF2010w / WF2510wf / WF2520 / WF2520nf / WF 2530 / WF2530wf / WF2540 / WF2540wf	Standard	165
T200120-D2	200	Black Twin Pack		Standard	175
T200220S	200	Cyan		Standard	165
T200320S	200	Magenta		Standard	165
T200420S	200	Yellow		Standard	165
T200520S	200	Cyan / Magenta / Yellow		Standard	165
T288120S	288	Black	Expression Home XP330 / XP430 / XP434 / XP440	Standard	175
T288120-D2	288	Black Twin Pack		Standard	175
T288120-BCS	288	Black / Cyan / Magenta / Yellow		Standard	175 Black, 165 Colour
T288220S	288	Cyan		Standard	165
T288320S	288	Magenta		Standard	165
T288420S	288	Yellow		Standard	165
T288520S	288	Cyan / Magenta / Yellow		Standard	165
T212120S	212	Black	Expression Home XP4100 / XP4105; Workforce WF2830 / WF2850	Standard	150
T212220S	212	Cyan		Standard	130
T212320S	212	Magenta		Standard	130
T212420S	212	Yellow		Standard	130
T202120S	202	Black	Expression Home XP5100; Workforce WF2860	Standard	210
T202220S	202	Cyan		Standard	165
T202320S	202	Magenta		Standard	165
T202420S	202	Yellow		Standard	165
T202XL120S	202XL	Black		High yield	550
T202XL220S	202XL	Cyan		High yield	470
T202XL320S	202XL	Magenta		High yield	470
T202XL420S	202XL	Yellow		High yield	470
T222120S	222	Black	Expression Home XP5200; Workforce 2960	Standard	210
T222220S	222	Cyan		Standard	185
T222320S	222	Magenta		Standard	185
T222420S	222	Yellow		Standard	185
T273020S	273	Black	Expression Premium XP520 / X600 / X605 / XP610 / XP615 / XP620 / XP700 / XP700 / XP710 / XP800 / XP810 / XP820	Standard	250
T273120S	273	Photo Black		Standard	300
T273220S	273	Cyan		Standard	300
T273320S	273	Magenta		Standard	300
T273420S	273	Yellow		Standard	300
T273520S	273	Cyan / Magenta / Yellow		Standard	300

Ink and Toner Cartridges

PRODUCT NO.	CARTRIDGE NO.	COLOUR	MODEL	TYPE	YIELD
EPSON® INKJET CARTRIDGES (continued)					
T410020S	410	Black	Expression Premium XP530 / XP630 / XP640 / XP710 / XP830	Standard	250
T410120S	410	Photo Black		Standard	300
T410220S	410	Cyan		Standard	300
T410320S	410	Magenta		Standard	300
T410420S	410	Yellow		Standard	300
T410520S	410	Black / Cyan / Magenta / Yellow		Standard	300
T124120S	124	Black	Stylus NX125 / NX127 / NX130 / NX230 / NX330 / NX420 / NX430; WorkForce 320 / 323 / 325 / 435	Standard	200
T124220S	124	Cyan		Standard	220
T124320S	124	Magenta		Standard	220
T124420S	124	Yellow		Standard	220
T069120S	69	Black	Stylus C120 / CX5000 / CX6000 / CX7000f / CX8400 / CX9400Fax / CX9475f / CX9475Fax / NX215 / NX300 / NX305 / NX400 / NX410 / NX415 / NX510 / NX515 / NX300 / NX400; Workforce 30 / 40 / 310 / 315 / 500 / 600 / 610 / 615 / 1100	Standard	245
T069220S	69	Cyan		Standard	350
T069320S	69	Magenta		Standard	350
T069420S	69	Yellow		Standard	350
T069520S	69	Cyan / Magenta / Yellow		Standard	350
T060120S	60	Black	Stylus C68 / C88 / C88+ / D68P / D88 / D88 Plus / CX3800 / CX3810 / CX4200 / CX4800 / CX5800f / CX7800 / DX3800 / DX4800	Standard	400
T060220S	60	Cyan		Standard	450
T060320S	60	Magenta		Standard	450
T060420S	60	Yellow		Standard	450
T125120S	125	Black	Stylus NX125 / NX127 / NX130 / NX230 / NX420 / NX530 / NX625; WorkForce 320 / 323 / 325 / 520	Standard	265
T125120-D2	125	Black Twin Pack		Standard	265
T125220S	125	Cyan		Standard	385
T125320S	125	Magenta		Standard	385
T125420S	125	Yellow		Standard	385
T125520S	125	Cyan / Magenta / Yellow		Standard	385
T127120S	127	Black	Stylus NX530 / NX625; WorkForce 545 / 60 / 630 / 633 / 635 / 645 / 840 / 845 / WF3520 / WF3520Dwf / WF3540 / WF3540dtwf / WF7010 / WF7510 / WF7520	Extra high yield	945
T127120-D2	127	Black Twin Pack		Extra high yield	945
T127220S	127	Cyan		Extra high yield	755
T127320S	127	Magenta		Extra high yield	755
T127420S	127	Yellow		Extra high yield	755
T127520S	127	Cyan / Magenta / Yellow		Extra high yield	755
T126120S	126	Black	Workforce 520 / 545 / 630 / 633 / 635 / 645 / 840 / 845 / 3520 / 3540 / 7010 / 7510 / 7520 / NX330 / 430	High yield	385
T126220S	126	Cyan		High yield	470
T126320S	126	Magenta		High yield	470
T126420S	126	Yellow		High yield	470
T702120S	702	Black	WorkForce Pro WF3733 / WF3720 / WF3730	Standard	300
T702120-BCS	702	Black / Cyan / Magenta / Yellow		Standard	350 Black, 300 Colour
T702220S	702	Cyan		Standard	300
T702320S	702	Magenta		Standard	300
T702420S	702	Yellow		Standard	300
T802120S	802	Black	WorkForce Pro WF4720 / WF4730 / WF4734 / WF4740	Standard	900
T802120-BCS	802	Black / Cyan / Magenta / Yellow		Standard	900 Black, 650 Colour
T802220S	802	Cyan		Standard	650
T802320S	802	Magenta		Standard	650
T802420S	802	Yellow		Standard	650
T220120S	220	Black	WorkForce WF2630 / WF2650 / WF2660 / WF2750 / WF2760	Standard	175
T220120-D2	220	Black Twin Pack		Standard	175
T220120-BCS	220	Black / Cyan / Magenta / Yellow		Standard	175 Black, 165 Colour
T220220S	220	Cyan		Standard	165
T220320S	220	Magenta		Standard	165
T220420S	220	Yellow		Standard	165
T220520S	220	Cyan / Magenta / Yellow		Standard	165

PRODUCT NO.	CARTRIDGE NO.	COLOUR	MODEL	TYPE	YIELD	
EPSON® INKJET CARTRIDGES (continued)						
T252120S	252	Black	WorkForce WF5620 / WF5690 / WF3620 / WF3640 / WF7610	Standard	350	
T252120-D2	252	Black Twin Pack		Standard	350	
T252120-BCS	252	Black / Cyan / Magenta / Yellow		Standard	350 Black, 300 Colour	
T252220S	252	Cyan		Standard	300	
T252320S	252	Magenta		Standard	300	
T252420S	252	Yellow		Standard	300	
T252520S	252	Cyan / Magenta / Yellow		Standard	300	
T252XL120S	252XL	Black		High yield	1,100	
T252XL220S	252XL	Cyan		High yield	1,100	
T252XL320S	252XL	Magenta		High yield	1,100	
T252XL420S	252XL	Yellow		High yield	1,100	
HP® LASER CARTRIDGES						
CC530A	304A	Black	Colour LaserJet CM2320fxi MFP / CM2320n MFP / CM2320nf MFP / P2025dn / P2025n / P2025x	Standard	3,500	
CC530AD	304A	Black Twin Pack		Standard	3,500	
CC531A	304A	Cyan		Standard	2,800	
CC533A	304A	Magenta		Standard	2,800	
CC532A	304A	Yellow		Standard	2,800	
CF340A	304A	Cyan / Magenta / Yellow		Standard	2,800	
CE400A	507A	Black	LaserJet Enterprise 500 M551dn / M551n / M551xh / MFP M575c / MFP M575dn / MFP M575f; LaserJet Pro MFP M570dn / MFP M570dw	Standard	5,500	
CE400X	507X	Black		High yield	11,000	
CE401A	507A	Cyan		Standard	6,000	
CE403A	507A	Magenta		Standard	6,000	
CE402A	507A	Yellow		Standard	6,000	
CF360A	508A	Black		Colour LaserJet Enterprise M577 / M553	Standard	6,000
CF361A	508A	Cyan	Standard		5,000	
CF363A	508A	Magenta	Standard		5,000	
CF362A	508A	Yellow	Standard		5,000	
CF360X	508X	Black	High yield		12,500	
CF361X	508X	Cyan	High yield		9,500	
CF363X	508X	Magenta	High yield		9,500	
CF362X	508X	Yellow	High yield		9,500	
CF350A	130A	Black	Colour LaserJet Pro M176 / M177		Standard	1,300
CF351A	130A	Cyan			Standard	1,000
CF353A	130A	Magenta		Standard	1,000	
CF352A	130A	Yellow		Standard	1,000	
CF400A	201A	Black	Colour LaserJet Pro M252 / M277	Standard	1,420	
CF401A	201A	Cyan		Standard	1,330	
CF403A	201A	Magenta		Standard	1,330	
CF402A	201A	Yellow		Standard	1,330	
CF400X	201X	Black		High yield	2,800	
CF401X	201X	Cyan		High yield	2,300	
CF403X	201X	Magenta		High yield	2,300	
CF402X	201X	Yellow		High yield	2,300	
W2110A	206A	Black	Colour LaserJet Pro MFP M283fdw / M283cdw	Standard	1,350	
W2111A	206A	Cyan		Standard	1,250	
W2113A	206A	Magenta		Standard	1,250	
W2112A	206A	Yellow		Standard	1,250	
CF410A	410A	Black	Colour LaserJet Pro M452 / M377 / M477	Standard	2,300	
CF411A	410A	Cyan		Standard	2,300	
CF413A	410A	Magenta		Standard	2,300	
CF412A	410A	Yellow		Standard	2,300	
CF410X	410X	Black		High yield	6,500	
CF411X	410X	Cyan		High yield	5,000	
CF413X	410X	Magenta		High yield	5,000	
CF412X	410X	Yellow		High yield	5,000	

Ink and Toner Cartridges

PRODUCT NO.	CARTRIDGE NO.	COLOUR	MODEL	TYPE	YIELD
HP® LASER CARTRIDGES (continued)					
W2020A	414A	Black	Colour LaserJet Pro M454dn / M454dw; LaserJet Pro MFP M479dw / M479fnw / M479fdw	Standard	2,400
W2021A	414A	Cyan		Standard	2,100
W2023A	414A	Magenta		Standard	2,100
W2022A	414A	Yellow		Standard	2,100
W2020X	414X	Black		High yield	7,500
W2021X	414X	Cyan		High yield	6,000
W2023X	414X	Magenta		High yield	6,000
W2022X	414X	Yellow		High yield	6,000
C7115A	15A	Black	LaserJet 1000 / 1200 / 1200n / 1200se / 1220 / 1220se / 3300mfp / 3310 / 3320mfp / 3320n mfp / 3330mfp / 3380	Standard	2,500
Q2612A	12A	Black	LaserJet 1018 / 1020 / 1022 / 3015 / 3020 / 3030 / 3050 / 3052 / 3055 / M1120 / M1319	Standard	2,000
Q2612D	12A	Black Twin Pack		Standard	2,000
CE390A	90A	Black	LaserJet 600 M601n / M601dn / M602n / M602dn / M602x / M603n / M603dn / M603xh / M4555h MFP / M4555f MFP / M4555fsm MFP	Standard	10,000
CE255A	55A	Black	LaserJet Enterprise 500 MFP M525dn / 500 MFP M525f / flow MFP M525c / P3015d / P3015dn / P3015n / P3015x; LaserJet Pro M521dn MFP	Standard	6,000
CE255XD	55X	Black Twin Pack		High yield	12,500
CF289A	89A	Black	LaserJet Enterprise M507 / MFP M528	Standard	5,000
CF287A	87A	Black	LaserJet Enterprise M527 / M506 / M501	Standard	8,550
CF287X	87X	Black		High yield	18,000
CF281A	81A	Black	LaserJet Enterprise M604dn / M604n / M605dn / M605n / M605x / M606dn / M606x / MFP M630f / MFP M630h / MFP M630z	Standard	10,500
CF237A	37A	Black	LaserJet Enterprise M608dn / M608n / M608x / M609dh / M609dn / M609x / MFP M631h / MFP M631z / MFP M632fht / MFP M632h / MFP M632z / MFP M633fh / MFP M633z	Standard	11,000
Q5949A	49A	Black	LaserJet 1160 / 1160Le / 1320 / 1320n / 1320nw / 1320t / 1320tn / 3390 / 3392	Standard	2,500
W1340A	134A	Black	LaserJet M208dw / M209dw / M211d / MFP M232 / MFP M233 / MFP M234 / MFP M236	Standard	1,100
W1340X	134X	Black		High yield	2,400
CB435A	35A	Black	LaserJet P1005 / P1006	Standard	1,500
CB435D	35A	Black Twin Pack		Standard	1,500
CB436A	36A	Black	LaserJet P1505 / P1505n / M1522n mfp / M1522nf mfp	Standard	2,000
CB436D	36A	Black Twin Pack		Standard	2,000
CE505A	5A	Black	LaserJet P2035 / P2055	Standard	2,300
CE505D	5A	Black Twin Pack		Standard	2,300
CC364A	64A	Black	LaserJet P4014n / P4014dn / P4015n / P4015dn / P4015tn / P4015x / P4515n / P4515tn / P4515x	Standard	10,000
CE410A	305A	Black	LaserJet Pro 300 / 400	Standard	2,090
CE410X	305X	Black		High yield	4,000
CE411A	305A	Cyan		Standard	2,600
CE413A	305A	Magenta		Standard	2,600
CE412A	305A	Yellow		Standard	2,600
CF370AM	305A	Cyan / Magenta / Yellow		Standard	2,600
W1380A	138A	Black	LaserJet Pro 3001dwe / 3001dw, LaserJet Pro MFP 3101fdwe / 3101fdw	Standard	1,500
W1380X	138X	Black		High Yield	4,000
CE320A	128A	Black	LaserJet Pro CM1415fnw MFP / CP1525nw	Standard	2,000
CE321A	128A	Cyan		Standard	1,300
CE323A	128A	Magenta		Standard	1,300
CE322A	128A	Yellow		Standard	1,300
CF217A	17A	Black		LaserJet Pro M102 / M130	Standard
CF219A	19A	Black	LaserJet Pro M102 / M130 / M132	Drum	12,000
CF294A	94A	Black	LaserJet Pro M118, MFP M148, MFP M149	Standard	1,200
CF279A	79A	Black	LaserJet Pro M12w / MFP M26nw	Standard	1,000
CE285A	85A	Black	LaserJet Pro M1212nf MFP / M1217nfw MFP / P1102w	Standard	1,600
CE285D	85A	Black Twin pack		Standard	1,600
CE278A	78A	Black	LaserJet Pro M1536dnf MFP / P1606dn	Standard	2,100
CE278D	78A	Black Twin Pack		Standard	2,100
CF283A	83A	Black	LaserJet Pro M201 / M125 / M127 / M225	Standard	1,500
CF283AD	83A	Black Twin pack		Standard	1,500
CF283X	83X	Black	LaserJet Pro M201 / M225	High yield	2,200
CF230A	30A	Black	LaserJet Pro M203 / M227	Standard	1,600
CF230X	30X	Black		High Yield	3,500
CF232A	32A	Black		Drum	23,000

Ink and Toner Cartridges

PRODUCT NO.	CARTRIDGE NO.	COLOUR	MODEL	TYPE	YIELD
HP® LASER CARTRIDGES (continued)					
CF210A	131A	Black	LaserJet Pro M251 / M276	Standard	1,520
CF210X	131X	Black		High yield	2,400
CF211A	131A	Cyan		Standard	1,800
CF213A	131A	Magenta		Standard	1,800
CF212A	131A	Yellow		Standard	1,800
CF500A	202A	Black	LaserJet Pro M254 / MFP M280 / MFP M281	Standard	1,400
CF501A	202A	Cyan		Standard	1,400
CF503A	202A	Magenta		Standard	1,400
CF502A	202A	Yellow		Standard	1,400
CF500X	202X	Black		High yield	3,200
CF280A	80A	Black	LaserJet Pro M401 / M425	Standard	2,560
CF280X	80X	Black		High yield	6,900
CF226A	26A	Black	LaserJet Pro M402dn / M402dw / M402n / M426fdn / M426fdw	Standard	3,100
CF226X	26X	Black		High yield	9,000
CF226XD	26X	Black Twin pack		High yield	9,000
CF258A	58A	Black	LaserJet Pro M404n / M404dn / M404dw / LaserJet Pro M428fdn / M428fdw	Standard	3,000
CF258X	58X	Black		High yield	10,000
CF248A	48A	Black	LaserJet Pro MFP M28a, MFP M28w and MFP M29w	Standard	1,000
W1480A	148A	Black	LaserJet Pro MFP M101fdw, LaserJet Pro 4001dw / 4001dn	Standard	2,900
W1143A	143A	Black	Neverstop 1001nw / 1202nw	Refill	5,000
W1143AD	143A	Black Twin Pack		Refill	5,000
HP® INKJET CARTRIDGES					
CH561WC140	61	Black	Deskjet 1000 / 1010 / 1012 / 1050 / 1051A / 1055 / 1056 / 1510 / 1512 / 1514 / 2050 / 2510 / 2512 / 2514 / 2540 / 2542 / 3000 / 3050 / 3050A / 3051A / 3052A / 3054 / 3054A / 3056A / 3510 / 3511 / 3512; Envy 4500 / 4501 / 4502 / 4504 / 4505 / 5530 / 5531 / 5535; OfficeJet 2620 / 4630 / 4632 / 4635	Standard	190
CR259FC140	61	Black / Colour		Standard	190 Black, 165 Colour
CH562WC140	61	Colour		Standard	165
CH563WC140	61XL	Black		High yield	480
CH564WC140	61XL	Colour		High yield	330
F6U62AN140	63	Black	Deskjet 1112 / 2130 / 2132 / 3630 / 3632; Envy 4512 / 4520; OfficeJet 3830 / 4650	Standard	190
LOR46AN140	63	Black / Colour		Standard	190 Black, 165 Colour
F6U61AN140	63	Colour		Standard	165
CB316WC140	564	Black	Deskjet 3520 / 3521 / 3522 / 3526; OfficeJet 4620 / 4622; Photosmart 5510 / 5511 / 5512 / 5514 / 5515 / 5520 / 5522 / 5525 / 6510 / 6512 / 6515 / 6520 / 6525 / 7510 / 7515 / 7520 / 7525 / B8550 / C6340 / C6350 / C6380 / D5445 / D5460 / D7560	Standard	250
CB318WC140	564	Cyan		Standard	300
CB319WC140	564	Magenta		Standard	300
CB320WC140	564	Yellow		Standard	300
CN684WC140	564XL	Black		High yield	550
N9K02AN140	65	Black	Deskjet 3752 / 3755	Standard	120
N9K01AN140	65	Colour		Standard	100
N9K04AN140	65XL	Black		High yield	300
N9K03AN140	65XL	Colour		High yield	300
C9351AC140	21	Black		DeskJet 3910 / 3930 / 3940 / D1420 / D1430 / D1445 / D1455 / D1560 / D2345 / D2360 / D2430 / D2445 / F350 / F380 / F2110 / F2140 / F2180 / F2240 / F4135 / F4140 / F4180; PSC 1410; OfficeJet 4315	Standard
C9352AC140	22	Colour	Standard		165
C9363WC140	97	Colour	DeskJet 5740 / 5940 / 6520 / 6540 / 6620 / 6830 / 6840 / 6940 / 6980 / 9800; OfficeJet 6210 / 6200 / H470 / 150 / 100 / 7210 / 7310 / 7410; Photosmart 8050 / 8450 / 8150 / 2610 / 2710 / 8750 / 8049 / B8350; PSC 1610 / 2355	High yield	560
C8766WC140	95	Colour	DeskJet 6520 / 6980 / 6940 / 5940 / 6840 / 6620 / 5940 / 6540; OfficeJet 6200 / 6210 / 6310 / 7210 / 7410; Photosmart 7850 / 8050 / D5160 / D5155 / D5145 / 8450 / 2610 / 2710 / 2575 / C4140 / C3135 / D5060 / 8750; PSC 2355 / 1610 / 1600	Standard	330
C8765WC140	94	Black	DeskJet 460 / 5740 / 6520 / 6540 / 6620 / 6840 / 6980; OfficeJet 7210 / 7410 / 6210 / 6200 / 7850; Photosmart C3135 / 8450 / 2610 / 2710 / 8750; PSC 1610 / 1600 / 2355	Standard	480
C9361WC140	93	Colour	Deskjet 5440 / 5440v / 5440xi / D4145 / D4155 / D4160; Photosmart 7850 / C3135 / C3140 / C3150 / C3180 / C4140 / C4150 / C4180; PSC 1507 / 1510 / 1510v / 1510xi	Standard	220
C9362WC140	92	Black	Deskjet 5440 / 5440v / 5440xi; Photosmart 7850 / C3135 / C3140 / C3150 / C3180; OfficeJet 6310 / 6310v / 6310xi / PSC 1507 / 1510 / 1510v / 1510xi	Standard	220
C9364WC140	98	Black	Deskjet 5940 / 5940xi / D4145 / D4155 / D4160; Photosmart 2570 / 2575 / 2575v / 2575xi / 8049 / 8050 / C4140 / C4150 / C4180 / D5060 / D5065 / D5069 / D5145 / D5155 / D5160; OfficeJet 100 / 150 / 6310 / 6310v / 6310xi / H470 / H470b / H470wb / H470wf	Standard	420

Ink and Toner Cartridges

PRODUCT NO.	CARTRIDGE NO.	COLOUR	MODEL	TYPE	YIELD	
HP® INKJET CARTRIDGES (continued)						
CC640WC140	60	Black	Deskjet D1660 / D2530 / D2545 / D2560 / D2660 / D2680 / D5560 / F2430 / F2440 / F2480 / F4210 / F4235 / F4240 / F4280 / F4435 / F4440 / F4480 / F4580; Envy 100 / 110 / 111 / 114 / 120 / 121; Photosmart C4635 / C4640 / C4650 / C4680 / C4740 / C4750 / C4780 / C4795; e-All-in-One Series	Standard	200	
CC643WC140	60	Colour		Standard	165	
N9H63FN140	60	Black / Colour		Standard	200 Black, 165 Colour	
CC641WC140	60XL	Black		High yield	600	
CC644WC140	60XL	Colour		High yield	440	
CB335WC140	74	Black	Deskjet D4260 / D4360; OfficeJet J5740 / J5750 / J5780 / J6450 / J6480; Photosmart C4210 / C4240 / C4250 / C4280 / C4285 / C4345 / C4380 / C4385 / C4435 / C4440 / C4450 / C4480 / C4488 / C4599 / C5240 / C5250 / C5540 / C5550 / C5580 / D5345 / D5360	Standard	200	
CB337WC140	75	Colour		Standard	170	
C6615DC	15	Black	Digital Copier 310; Deskjet 810c / 812c / 825c / 825civr / 840c / 841c / 842c / 843c / 845c / 845civr / 920c / 940c / 940civr / 3820; Fax 1230 / 1230xi; OfficeJet v40 / v40xi / 5110 / 5110v / 5110xi / PSC 500 / 500xi / 750 / 750xi / 950 / 950vr / 950xi	Standard	500	
C6656AC	56	Black	Deskjet 450 / 5550 / 5650 / 5850 / 9650 / 9680; Officejet 4215 / 5610 / 6110; Photosmart 7260 / 7350 / 7450 / 7550 / 7755 / 7760 / 7762 / 7960; PSC 1210 / 1315 / 1350 / 2110 / 2175 / 2210 / 2410	Standard	520	
C6657AC	57	Colour	Deskjet 450, 5550, 5650, 5850, 9650, 9680; Officejet 4215, 6000, 6110, 7000; Photosmart 7260, 7350, 7450, 7550, 7755, 7760, 7762, 7960; PSC 1210, 1315, 1350, 2110, 2175, 2210, 2410	Standard	500	
F6U64AN140	63XL	Black	Envy 4520 / 4522; OfficeJet 3830 / 4650; DeskJet 1110 / 1112 / 2130 / 3630 / 3632	High yield	480	
F6U63AN140	63XL	Colour		High yield	330	
C2P04AN140	62	Black	Envy 5540 / 5542 / 5544 / 5545 / 5640 / 5642 / 5643 / 5660 / 5665 / 7640 / 7645; OfficeJet 5740 / 5741 / 5742 / 5743 / 5744 / 5745 / 5746 / 8040	Standard	200	
C2P06AN140	62	Colour		Standard	200	
C2P05AN140	62XL	Black		High yield	600	
C2P07AN140	62XL	Colour		High yield	600	
3YM56AN140	67	Black	ENVY 6052, 6055, 6058, 6075, HP ENVY Pro 6452, 6455, 6458 HP DeskJet 1255, 2732, 2752, 2755, DeskJet Plus 4140, 4152, 4155, 4158	Standard	120	
3YM55AN140	67	Colour		Standard	100	
3YM57AN140	67XL	Black		Standard	240	
3YM58AN140	67XL	Colour		Standard	200	
N9J90AN140	64	Black	Envy Photo 6255 / 7155 / 7855	Standard	200	
N9J89AN140	64	Colour		Standard	165	
N9J92AN140	64XL	Black		High yield	600	
N9J91AN140	64XL	Colour		High yield	415	
CD975AC140	920XL	Black	OfficeJet 6000 / 6500 / 7000 / 7500	High yield	1,200	
CD972AC140	920XL	Cyan		High yield	700	
CD973AC140	920XL	Magenta		High yield	700	
CD974AC140	920XL	Yellow		High yield	700	
CN053AC140	932XL	Black	OfficeJet 6100 / 6600 / 6700 / 7110 / 7610	High yield	1,000	
CN054AC140	933XL	Cyan		High yield	825	
CN055AC140	933XL	Magenta		High yield	825	
CN056AC140	933XL	Yellow		High yield	825	
C2P23AN140	934XL	Black	OfficeJet 6812; OfficeJet Pro 6230 / 6830 / 6835	High yield	1,000	
C2P24AN140	935XL	Cyan		High yield	1,000	
C2P25AN140	935XL	Magenta		High yield	1,000	
C2P26AN140	935XL	Yellow		High yield	1,000	
T6L98AN140	902	Black	OfficeJet 6950 / 6951 / 6954 / 6962; OfficeJet Pro 6960 / 6961 / 6963 / 6964 / 6965 / 6966 / 6968 / 6970 / 6971 / 6974 / 6975 / 6976 / 6978 / 6979	Standard	300	
T6L86AN140	902	Cyan		Standard	315	
T6L90AN140	902	Magenta		Standard	315	
T6L94AN140	902	Yellow		Standard	315	
T6M14AN140	902XL	Black		High yield	825	
T6M02AN140	902XL	Cyan		High yield	825	
T6M06AN140	902XL	Magenta		High yield	825	
T6M10AN140	902XL	Yellow		High yield	825	
T6M18AN140	906XL	Black		OfficeJet 6951 / 6954 / 6962; OfficeJet Pro 6968 / 6974 / 6975 / 6978 / 6979	High yield	1,500
3YL61AN140	910	Black		OfficeJet 8020 / 8022 / 8025 / 8028 / 8035	Standard	300
3YL58AN140	910	Cyan	Standard		315	
3YL59AN140	910	Magenta	Standard		315	
3YL60AN140	910	Yellow	Standard		315	
3YL65AN140	910XL	Black	High yield		825	
3YL62AN140	910XL	Cyan	High yield		825	
3YL63AN140	910XL	Magenta	High yield		825	
3YL64AN140	910XL	Yellow	High yield		825	

Ink and Toner Cartridges

PRODUCT NO.	CARTRIDGE NO.	COLOUR	MODEL	TYPE	YIELD
HP® INKJET CARTRIDGES (continued)					
CN049AC140	950	Black	OfficeJet Pro 251dw / 276dw / 8100 / 8600 / 8600 Plus / 8600 Premium / 8610 / 8615 / 8620 / 8625 / 8630	Standard	1,000
CN050AC140	951	Cyan		Standard	700
CN051AC140	951	Magenta		Standard	700
CN052AC140	951	Yellow		Standard	700
CN045AC140	950XL	Black		High yield	2,300
F6U15AN140	952	Black	OfficeJet Pro 8710 / 8715 / 8720 / 8725 / 8730 / 8740	Standard	1,000
LOS49AN140	952	Cyan		Standard	700
LOS52AN140	952	Magenta		Standard	700
LOS55AN140	952	Yellow		Standard	700
N9K27AN140	952	Cyan / Magenta / Yellow		Standard	700
F6U19AN140	952XL	Black		High yield	2,000
LOS61AN140	952XL	Cyan		High yield	1,600
LOS64AN140	952XL	Magenta		High yield	1,600
LOS67AN140	952XL	Yellow		High yield	1,600
LOR39AN140	956XL	Black		OfficeJet Pro 8720 / 8725 / 8730 / 8740	High yield
3HZ99AN140	962	Black	OfficeJet Pro 9010 / 9015 / 9016 / 9018 / 9020 / 9025 / 9028	Standard	1,000
3HZ96AN140	962	Cyan		Standard	700
3HZ97AN140	962	Magenta		Standard	700
3HZ98AN140	962	Yellow		Standard	700
3YP00AN140	962	Cyan / Magenta / Yellow		Standard	700
3JA03AN140	962XL	Black		High yield	2,000
3JA00AN140	962XL	Cyan		High yield	1,600
3JA01AN140	962XL	Magenta		High yield	1,600
3JA02AN140	962XL	Yellow		High yield	1,600
CB317WC140	564	Photo Black		Photosmart 7510 / 7515 / 7520 / 7525 / B8550 / C6340 / C6350 / C6380 / D5445 / D5460 / D7560	Standard
LEXMARK™ LASER CARTRIDGES					
B221000	B221000	Black	B2236dw / MB2236adw	Standard - Return Program	1,200
B221H00	B221H00	Black		High yield - Return Program	3,000
B221X00	B221X00	Black		Extra high yield - Return Program	6,000
B231000	B231000	Black	B2338dw / B2442dw / B2650dw / MB2338adw / MB2442adwe / MB2546adwe / MB2650adwe	Standard - Return Program	3,000
C3210K0	C3210K0	Black	C3224dw / MC3224adwe / MC3326adwe	Standard - Return Program	1,500
C3210C0	C3210C0	Cyan		Standard - Return Program	1,500
C3210M0	C3210M0	Magenta		Standard - Return Program	1,500
C3210Y0	C3210Y0	Yellow		Standard - Return Program	1,500
C331HK0	C331HK0	Black	C3326dw	High yield - Return Program	3,000
C331HC0	C331HC0	Cyan		High yield - Return Program	2,500
C331HM0	C331HM0	Magenta		High yield - Return Program	2,500
C331HY0	C331HY0	Yellow		High yield - Return Program	2,500
70C1HK0	701HK	Black	CS310dn / CS310n / CS317dn / CS410dn / CS410dtn	High yield - Return Program	4,000
70C1HC0	701HC	Cyan		High yield - Return Program	3,000
70C1HM0	701HM	Magenta		High yield - Return Program	3,000
70C1HY0	701HY	Yellow		High yield - Return Program	3,000

Ink and Toner Cartridges

PRODUCT NO.	CARTRIDGE NO.	COLOUR	MODEL	TYPE	YIELD
LEXMARK™ LASER CARTRIDGES (continued)					
71B10K0	71B10K0	Black	CS317dn / CS417dn / CS517de / CX317dn / CX417de and CX517de	Standard - Return Program	3,000
71B10C0	71B10C0	Cyan		Standard - Return Program	2,300
71B10M0	71B10M0	Magenta		Standard - Return Program	2,300
71B10Y0	71B10Y0	Yellow		Standard - Return Program	2,300
20N10K0	20N10K0	Black	CS331, CX331, CS431, CX431	Standard - Return Program	1,500
20N10C0	20N10C0	Cyan		Standard - Return Program	1,500
20N10M0	20N10M0	Magenta		Standard - Return Program	1,500
20N10Y0	20N10Y0	Yellow		Standard - Return Program	1,500
80C15K0	8015K	Black	CX410de / CX410dte / CX410e / CX510de / CX510dhe / CX510dthe	Standard - Return Program	2,500
80C15C0	8015C	Cyan		Standard - Return Program	2,000
80C15M0	8015M	Magenta		Standard - Return Program	2,000
80C15Y0	8015Y	Yellow		Standard - Return Program	2,000
80C1HK0	801HK	Black		High yield - Return Program	4,000
80C1HC0	801HC	Cyan		High yield - Return Program	3,000
80C1HM0	801HM	Magenta		High yield - Return Program	3,000
80C1HY0	801HY	Yellow		High yield - Return Program	3,000
E250A11A	E250A11A	Black	E250d / 250dn / 250dt / 250dtn / 350d / 350dn / 352dn / 352dtn	Standard - Return Program	3,500
E250X22G	E250X22G		E250 / E350 / E352 / E450	Photoconductor unit	30,000
E260A11A	E260A11A	Black	E260 / 260d / 260dn / 260dt / 260dtn / 360d / 360dn / 360dt / 360dtn / 460dn / 460dtn / 460dtw / 460dw / 462dtn	Standard - Return Program	3,500
E260X22G	E260X22G		E260 / E360 / E460	Photoconductor unit	30,000
B241H00	B241H00	Black	B/MB2442, 2546, 2650	Standard - Return Program	6,000
B341000	B341000	Black	MB3442adw	Standard yield - Return Program	1,500
C2310K0	C2310K0	Black	MC2640adwe / C2325dw / C2535dw / MC2325adw / C2425dw / MC2425adw / MC2535adwe	Standard - Return Program	1,000
C2310C0	C2310C0	Cyan		Standard - Return Program	1,000
C2310M0	C2310M0	Magenta		Standard - Return Program	1,000
C2310Y0	C2310Y0	Yellow		Standard - Return Program	1,000
C231HK0	C231HK0	Black		High yield - Return Program	3,000
C231HC0	C231HC0	Cyan		High yield - Return Program	3,000
C231HM0	C231HM0	Magenta		High yield - Return Program	3,000
C231HY0	C231HY0	Yellow		High yield - Return Program	3,000
C241XK0	C241XK0	Black	MC2640adwe / C2325dw / C2425dw / MC2425adw / MC2535adwe	Extra high yield - Return Program	6,000
C241XC0	C241XC0	Cyan		Extra high yield - Return Program	3,500
C241XM0	C241XM0	Magenta		Extra high yield - Return Program	3,500
C241XY0	C241XY0	Yellow		Extra high yield - Return Program	3,500

Ink and Toner Cartridges

PRODUCT NO.	CARTRIDGE NO.	COLOUR	MODEL	TYPE	YIELD
LEXMARK™ LASER CARTRIDGES (continued)					
50F1000	501	Black	MS310 / MS310d / MS310dn / MS312dnw / MS312dn / MS315dn / MX410de / MS415dn / MS510 / MS510dn / MX511de / MS610dn / MS610dte / MS610dtn and MX611de	Standard - Return Program	1,500
50F1H00	501H	Black		High yield - Return Program	5,000
50F1X00	501X	Black	MS410 / MS510 / MS610 series	Extra high yield - Return Program	20,000
50F1U00	501U	Black	MS510 / MS610 series	Ultra high yield - Return Program	20,000
51B1000	51B1000	Black	MS317dn / MS417dn / MS517dn / MS617dn / MX317dn / MX417de / MX517de / MX617de	Standard - Return Program	2,500
51B1H00	51B1H00	Black		High yield - Return program	8,500
50F0Z00	50F0Z00	Black	MS/MX31x, 41x, 51x, 61x	Imaging Unit - Return program	60,000
56F1000	56F1000	Black	MS321dn / MS421 / MS521 Series / MS621dn / MS622de / MX321 / MX421 / MX521 / MX522adhe / MX622	Standard - Return Program	6,000
56F1H00	56F1H00	Black		High yield - Return program	15,000
56F1X00	56F1X00	Black		Extra high yield - Return Program	20,000
56F0Z00	56F0Z00	Black	MS/MX32x, 42x, 52x, 62x, M /XM12xx, 32xx, B/MB2x	Imaging Unit - Return program	60,000
55B1000	55B1000	Black	MS331dn / MX331adn / MS431dn / MX431adw / MX431adn / MS431dw	Standard - Return Program	3,000
55B1H00	55B1H00	Black		High yield - Return program	15,000
58D1000	58D1000	Black	MS725 / MS821 / MS822 / MS823 / MS825 / MS826 / MX721 / MX722 / MX725 / MX822 / MX826	Standard - Return Program	7,500
58D1H00	58D1H00	Black		High yield - Return program	15,000
58D1X00	58D1X00	Black		Extra high yield - Return Program	35,000
58D1U00	58D1U00	Black		Ultra high yield - Return Program	55,000
52D1000	521	Black	MS810de / MS810dn / MS810dtn / MS810n / MS811dn / MS811dtn / MS811n / MS812de / MS812dn / MS812dtn	Standard - Return Program	6,000
52D1H00	521H	Black		High yield - Return program	25,000
52D1X00	521X	Black		Extra high yield - Return Program	45,000
60F1000	601	Black	MX310dn / MX410de / MX510de / MX511de / MX511dhe / MX511dte / MX511dte MFP / MX610de / MX611de / MX611dhe / MX611dte	Standard - Return Program	2,500
60F1H00	601H	Black		High yield - Return program	10,000
60F1X00	601X	Black		Extra high yield - Return Program	20,000
55B1X00	55B1X00	Black	MX431adw	Extra high yield - Return Program	20,000
62D1000	621	Black	MX710de / MX710dhe / MX711de / MX711dhe / MX711dte / MX711dthe / MX810de / MX810dfe / MX810dme / MX810dpe / MX810dte / MX810dtfe / MX810dtme / MX810dtp / MX810dxe / MX810dxfe	Standard - Return Program	6,000
62D1H00	621H	Black		High yield - Return program	25,000
62D1X00	621X	Black	MX711de / MX711dhe / MX711dte / MX711dthe / MX810de / MX810dfe / MX810dme / MX810dpe / MX810dte / MX810dtfe / MX810dtme / MX810dtp / MX810dxe / MX810dxpe	Extra high yield - Return Program	45,000
T650A11A	T650A11A	Black	T650dn / 650dtn / 650n / 652dn / 652dtn / 652n / 654dn / 654dtn / 654n / 656dne	Standard - Return Program	7,000
T650H11A	T650H11A	Black		High yield - Return program	25,000
X264A11G	X264A11G	Black	X264dn / 363dn / 364dn / 364dw	Standard - Return Program	3,500
X264H11G	X264H11G	Black		High yield - Return program	9,000

Ink and Toner Cartridges

PRODUCT NO.	CARTRIDGE NO.	COLOUR	MODEL	TYPE	YIELD
OKI DATA® RIBBONS					
52102001	52102001	Black	Microline 320 Turbo	Ribbon	
42377801	42377801	Black	Microline 420 / 421 / 490 / 491 Dot Matrix	Ribbon	
SAMSUNG® LASER CARTRIDGES					
SU901A	203L	Black	M3320 / M3370 / M3820 / SLM3320nd / SLM3370fd / SLM3820nd / SLM3870 / SLM4070 / SLM4072fd	High yield	5,000
SU750A	104S	Black	ML1660 / ML1660k / ML1661 / ML1661k / ML1665 / ML1665k / ML1665i / ML1665w / ML1665wk / ML1666 / ML1667 / ML1670 / ML1670k / ML1671 / ML1672 / ML1673 / ML1674 / ML1675	Standard	1,500
SU778A	105S	Black	ML1910 / ML1910k / ML1911 / ML1915 / ML1915k / ML1915n / ML1916k / ML2520 / ML2525 / ML2525k / ML2525w / ML2526 / ML2540 / ML2540r / ML2541 / ML2545 / ML2546 / ML2547 / ML2580 / SCX460x / SCX4610 / SCX462x / SF650 / CF650	Standard	1,500
SU700A	101S	Black	ML2160 / ML2161 / ML2162 / ML2162g / ML2162w / ML2163 / ML2163g / ML2164g / ML2164gw / ML2164w / ML2165 / ML2165w / ML2168g / SCX3400 / SCX3400f / SCX3400fh / SCX3401	Standard	1,500
SU720A	103L	Black	ML2955dw / SCX4729fw	High yield	1,500
SU967A	205L	Black	ML3300 / ML3310 / ML3312 / ML3710 / ML3712 / SCX4833 / SCX4835 / SCX5637 / SCX5639 / SCX5737 / SCX5739	High yield	5,000
SU770A	105L	Black	SF650 Series / ML1910 / ML1915 / ML2525 Series / Samsung ML1915 / SCX4600 / SCX4623 Series	High yield	2,500
SU814A	111S	Black	Xpress SLM2020W, SLM2060FH, SLM2070FW, SLM2070W	Standard	1,000
SU832A	116L	Black	Xpress SLM2625 / SLM2625d / SLM2626 / SLM2626d / SLM2675f / SLM2675fn / SLM2675hn / SLM2675n // SLM2676fh / SLM2676n / SLM2825dw / SLM2825nd / SLM2826nd / SLM2835dw	High yield	3,000
XEROX® LASER CARTRIDGES					
106R04347	106R04347	Black	B205, B210, B215	Standard	3,000
101R00664	101R00664	Black		Drum	10,000
106R01374	106R01374	Black	Phaser 3250	Standard	5,000
106R01412	106R01412	Black	Phaser 3300MFP	High yield	8,000
106R02305	106R02305	Black	Phaser 3320	Standard	5,000
106R03624	106R03624	Black	Phaser 3330, WorkCentre 3335, 3345	Standard	15,000
101R00555	101R00555	Black		Drum	30,000
106R02759	106R02759	Black	Phaser 6020 / 6022	Standard	2,000
106R02756	106R02756	Cyan		Standard	1,000
106R02757	106R02757	Magenta		Standard	1,000
106R02758	106R02758	Yellow		Standard	1,000
106R01485	106R01485	Black	WorkCentre 3210 / 3220	Standard	2,000
106R01486	106R01486	Black		High yield	4,100
106R02775	106R02775	Black	WorkCentre 3215 / 3225; Phaser 3260	Standard	1,500
106R02777	106R02777	Black	Workcentre 3225	High yield	3,000
106R02311	106R02311	Black	WorkCentre 3315dn / 3325dni	Standard	5,000
106R01530	106R01530	Black	WorkCentre 3550	High yield	11,000
106R03480	106R03480	Black	WorkCentre 6515	Standard	5,500
106R03690	106R03690	Cyan		Standard	4,300
106R03691	106R03691	Magenta		Standard	4,300
106R03692	106R03692	Yellow		Standard	4,300

PRODUCT NO.	CARTRIDGE NO.	COLOUR	MODEL	TYPE	YIELD
DATAPRODUCTS® COMPATIBLE INKJET CARTRIDGES					
DPC7935	DPC7935	Red	Pitney Bowes Postage Meter DM100i / DM125 / DM125i / DM150i / DM175i / DM200L / DM225 / P700 / SendPro® 300 / C Series	Standard	3,000
DPC7970	DPC7970	Red	Pitney Bowes postage meter Mailstation /Mailstation2 K700 / Mailstation /Mailstation2 K7M0	Standard	800
DATAPRODUCTS® COMPATIBLE INK ROLLERS					
R1180	IR40	Black	Canon CP1000, Casio 115ER / 116ER / 800ER / FR90 / 95 / 101 / 101S / 105 / 105S / 107 / 122 / 101S / 121S / 1215S / HR7 / 8 / 15 / 16 / 100 / 100A / 100S / 200 / SR1; Casio HR10RC; Royal 100P; Sharp EL1197P; Texas Instruments TI5015 / 5024 / 5027 / 5027II / 5029 / 5030 / 5030II / 5034 / 5040; Victor 1205 / 12054 / 1208 / 1210 / 1225 / 1240	Ink Roller	
R1427	IR40T	Red / Black	Canon CP13 / MP12D / MP120DH / MP120DL / MP120DLE / P120DH / P121DH / P15D / P160DH / P170DH / P2DH / P200DH / P200DHII / P200DHIII / P22D / P22DX / P220DH / P23DE / P23DH / P23DHII / P23DHIII / P23DHV / P23DHVG / P26DH / P32D; Casio 1215S / 2215 / FR110 / FR110HT / FR110S / FR110 / FR120C / FR125 / FR125 / FR127 / FR2215 / FR2215S / FR2600 / FR2650 / FR2650A / FR2650 Plus / FR320 / FR50 / FR 520 / HR100LC / HR100T / HR100TE / HR100TE Plus / HR100TM / HR100TM Plus / HR110S / HR120T / HR150LC / HR150LC Plus / HR150LCS / HR150LS Plus / HR150TE / HR150TE Plus / HR150TM / HR150TM Plus / HR160L / HR170L / HR170LB / HR18 / HR21; Citizen CX110 / CX115 / CX123 / CX212 / CX215 / CX220 / CX55 / CX88; Royal 224PD / Sharp EL1614; Victor 12082 / 12123A / 12253A	Ink Roller	
R1486	CP12	Purple	Canon P20D; Citizen CX40; Royal PD12; Sharp EL1610	Ink Roller	
DATAPRODUCTS® COMPATIBLE RIBBONS					
R3027	19-2076-891	Red / Black	Adler 1012PDII / 121PD / 1428PD; Canon P1015D / CP1212 / MP1218; Casio DL210 / DR120R / DR6220P / R320; Citizen 107DP / 127DP / 145DP; Epson 210 / M210; Sharp CS1181 / EL1197P / EL2607RIII / EL2615PIII / EL2630PIII / QS107	Ribbon	
FUZION® COMPATIBLE LASER CARTRIDGES					
GSDR400	(DR400)	Black	Brother DCP1200 / DCP1400 / HL1030 / HL1230 / HL1240 / HL1240dx / HL1250 / HL1250dx / HL1270 / HL1270n / HL1430 / HL1435 / HL1440 / HL1450 / HL1470n	Drum	20,000
GSTN350-NC	(TN350)	Black	Brother DCP7020 / HL2040 / HL2070n / MFC7220 / FAX2820 / FAX2910 / FAX2920	Standard	2,500
GSTN360-NC	(TN360)	Black	Brother DCP7030 / DCP7040 / HL2140 / HL2170dw / HL2170w / MFC7340 / MFC7345n / MFC7440n / MFC7840n / MFC7840w	High yield	2,600
GSDR360-NC	(DR360)	Black		Drum	12,000
GSTN420-NC	(TN420)	Black	Brother DCP7060d / DCP7065dn / HL2220 / HL2230 / HL2240 / HL2240d / HL2270dw / HL2275dw / HL2280dw / MFC7240 / MFC7360n / MFC7460dn / MFC7860dw	Standard	1,200
GSTN450-NC	(TN450)	Black		High yield	2,600
GSTN750-NC	(TN750)	Black	Brother DCP8110dn / DCP8150dn / DCP8155dn / HL5440d / HL5450dn / HL5450dnt / HL5470dw / HL5470dwt / HL6180dw / HL6180dwt / MFC8510dn / MFC8710dw / MFC8910dw / MFC8950dw / MFC8950dwt	High yield	8,000
GSTN660-NC	(TN660)	Black	Brother DCPL2520d / DCPL2520dw / DCPL2540dn / DCPL2540dw / HLL2300 / HLL2300d / HLL2305w / HLL2315dw / HLL2320d / HLL2340dw / HLL2360dn / HLL2360dw / HLL2380dw / MFCL2680w	High yield	2,600
GSDR630-NC	(DR630)	Black		Drum	12,000
GSTN730-NC	(TN730)	Black	Brother DCPL2550dn / DCPL2550dw / HLL2350dw / HLL2370dn / HLL2370dw / HLL2370dwXL / HLL2375dw / HLL2390dw / HLL2395dw / MFCL2710dn / MFCL2710dw / MFCL2750dw / MFCL2750dwXL	Standard	1,200
GSTN760-NC	(TN760)	Black		High yield	3,000
GSDR730-NC	(DR730)	Black		Drum	12,000
GSTN820-NC	(TN820)	Black	Brother DCPL5500 / DCPL5600 / DCPL5650 / HLL5000 / HLL5100 / HLL5200 / HLL6200 / HLL6250 / HLL6300 / HLL6400 / HLL6900 / MFCL5700 / MFCL5755 / MFCL5800 / MFCL5850 / MFCL5900	Standard	3,000
GSTN850-NC	(TN850)	Black		High yield	8,000
GSDR820-NC	(DR820)	Black		Drum	50,000
GSTN221K-NC	(TN221K)	Black	Brother HL3140cw / HL3170cdw / HL3180cdw / MFC9130cw / MFC9330cdw / MFC9340cdw	Standard	2,500
GSTN225C-NC	(TN225C)	Cyan		High yield	2,200
GSTN225M-NC	(TN225M)	Magenta		High yield	2,200
GSTN225Y-NC	(TN225Y)	Yellow		High yield	2,200
GSTN433K-NC	(TN433K)	Black	Brother HLL8260cdw / HLL8360cdw / HLL8360cdwmt / HLL8360cdwt / MFCL8610cdw / MFCL8900cdw	High yield	4,500
GSTN433C-NC	(TN433C)	Cyan		High yield	4,000
GSTN433M-NC	(TN433M)	Magenta		High yield	4,000
GSTN433Y-NC	(TN433Y)	Yellow		High yield	4,000
GSCAN128-NC	(128)	Black	Canon Faxphone L100 / imageCLASS D520 / D530 / D550 / iMF4450 / MF4570dn / MF4770n / MF4880dw / MF4890dw	Standard	5,000
GSCAN104-NC	(104)	Black	Canon FAXPHONE L90 / Canon imageCLASS D420 / D480 / MF4140 / MF4150 / MF4270 / MF4350d / MF4370dn / MF4690	Standard	2,000

Ink and Toner Cartridges

PRODUCT NO.	CARTRIDGE NO.	COLOUR	MODEL	TYPE	YIELD
FUZION® COMPATIBLE LASER CARTRIDGES (continued)					
GSCAN137-NC	(137)	Black	Canon ImageCLASS D570 / LBP151dw / MF212w / MF216n / MF227dw / MF229dw / MF232w / MF236n / MF244dw / MF247dw / MF249dw	Standard	2,400
GS12A-NC	(12A)	Black	HP LaserJet 1010 / 1012 / 1015 / 1018 / 1020 / 1022 / 1022n / 1022nw / 3015 / 3020 / 3030 / 3050 / 3052 / 3055 / M1005 / M1319	Standard	2,000
GS35A-NC	(35A)	Black	HP LaserJet P1002 / P1003 / P1004 / P1005 / P1006 / P1009	Standard	1,500
GS36AUNI-NC	(36A)	Black	HP LaserJet P1005 / P1006 / P1505 / M1522n / 1522nf / 1120	Standard	2,000
GS80A-NC	(80A)	Black	HP LaserJet Pro 400 M401a MFP / M401d MFP / M401dn MFP / M401dne MFP / M401dw MFP / M425dn MFP / M425dw MFP / M401n	Standard	2,700
GS80X-NC	(80X)	Black		High yield	6,900
GS85A-NC	(85A)	Black	HP LaserJet Pro M1132 MFP / M1136 MFP / M1212nf MFP / M1217nfw MFP / P1102 / P1102s / P1102w / P1104 / P1104w / P1106 / P1106w / P1107 / P1107w / P1108 / P1108w / P1109 / P1109w	Standard	1,600
GS78A-NC	(78A)	Black	HP LaserJet Pro M1536dnf / P1566 / P1606dn	Standard	2,100
GSCF226A-NC	(26A)	Black	HP LaserJet Pro M402dn / M402dw / M402n / M426fdn / M426fdw	Standard	3,100
GSCF226X-NC	(26X)	Black		High yield	9,000
GSLXMS410-NC	(501X)	Black	Lexmark MS410d / MS410dn / MS415dn / MS510dn / MS610de / MS610dn / MS610dte / MS610dtn	Extra high yield	10,000
GSLXMX310-NC	(601H)	Black	Lexmark MX310dn / MX410de / MX510de / MX511de / MX511dhe / MX511dte / MX521de / MX522adhe / MX610de / MX611de / MX611dfe / MX611dhe / MX611dte / MX622adhe	High yield	10,000
GSOKIUNI	(52102001)	Black	Okidata Microline 120 / 172 / 180 / 182 / 182 Plus / 182 Turbo / 183 / 184 Turbo	Ribbon	
GSMLTD1045-NC	(MLT-D1045)	Black	Samsung ML1660 / ML1660k / ML1661 / ML1661k / ML1665 / ML1665k / ML1665l / ML1665w / ML1665wk / ML1666 / ML1667 / ML1670 / ML1670k / ML1671 / ML1672 / ML1673 / ML1674 / ML1675	Standard	1,500
GSMLTD1015-NC	(MLT-D1015)	Black	Samsung ML2160 / ML2161 / ML2162 / ML2162g / ML2162w / ML2163 / ML2163g / ML2164g / ML2164gw / ML2164w / ML2165 / ML2165w / ML2168g / SCX3400 / SCX3400f / SCX3400fh / SCX3401	Standard	1,500
GSX3215-NC	(106R02777)	Black	Xerox Phaser 3260di / 3260dni / 3260vdi / 3260vdni / WorkCentre 3215ni / 3215vni / 3225dni / 3225vdni / 3225vdni / 3225vdni	High yield	3,000
FUZION® COMPATIBLE INKJET CARTRIDGES					
IJLC103K	(LC103KS)	Black	Brother DCPJ152w / DCPJ752dw / J4110dw / MFCJ245 / MFCJ285dw / MFCJ450dw / MFCJ470dw / MFCJ4310dw / MFCJ4410dw / MFCJ4510dw / MFCJ4610dw / MFCJ4710dw / MFCJ650dw / MFCJ6520dw / MFCJ6720dw / MFCJ6920dw / MFCJ870dw / MFCJ875dw	High yield	600
IJLC103C	(LC103CS)	Cyan		High yield	600
IJLC103M	(LC103MS)	Magenta		High yield	600
IJLC103Y	(LC103YS)	Yellow		High yield	600
IJLC75K	(LC75KS)	Black	Brother DCPJ525w / DCPJ725dw / DCPJ925dw / MFCJ280w / MFCJ425w / MFCJ430w / MFCJ435w / MFCJ5910dw / MFCJ625dw / MFCJ625w / MFCJ6510dw / MFCJ6710dw / MFCJ6910dw / MFCJ825dw / MFCJ835dw	High yield	600
IJLC75C	(LC75CS)	Cyan		High yield	600
IJLC75M	(LC75MS)	Magenta		High yield	600
IJLC75Y	(LC75YS)	Yellow		High yield	600
IJLC203XLK	(LC203KS)	Black	Brother MFCJ4420dw / MFCJ460dw / MFCJ4620dw / MFCJ4620dw / MFCJ480dw / MFCJ485dw / MFCJ5520dw / MFCJ5620dw / MFCJ5620dw / MFCJ5720dw / MFCJ5720dw / MFCJ680dw / MFCJ880dw	High yield	550
IJLC203XLC	(LC203CS)	Cyan		High yield	550
IJLC203XLM	(LC203MS)	Magenta		High yield	550
IJLC203XLY	(LC203YS)	Yellow		High yield	550
IJCLI251XLC	(251XL)	Cyan	Canon PIXMA iP7220 / iP8720 / iX6820 / MG5420 / MG5520 / MG5522 / MG5620 / MG5622 / MG6320 / MG6420 / MG6620 / MG7120 / MG7520 / MX722 / MX922 / MX925 / iX6820 / iX6850 / iP7220 / iP7250 / iP8720 / iP8750	High yield	665
IJCLI251XLM	(251XL)	Magenta		High yield	660
IJCLI251XLY	(251XL)	Yellow		High yield	685
IJPG210XLK	(210XL)	Black	Canon PIXMA iP2702 / MP240 / MP250 / MP258 / MP270 / MP280 / MP282 / MP480 / MP490 / MP495 / MX320 / MX330 / MX340 / MX340 Office / MX350 / MX350 Office / MX360 / MX410 / MX420	High yield	400
IJPGI250XLK	(250XL)	Black	Canon PIXMA iP7220 / iP8720 / iX6820 / MG5420 / MG5520 / MG5522 / MG5620 / MG5622 / MG6320 / MG6420 / MG6620 / MG7120 / MG7520 / MX722 / MX922	High yield	500



A BROTHER MFC-L3710CW DIGITAL COLOUR ALL-IN-ONE WITH WIRELESS NETWORKING

Fast, reliable high-impact colour for home and small business. Wireless networking. 3.7" colour touchscreen display. Prints, copies, scans and faxes. Offers wireless printing from your mobile device via AirPrint™, Google Cloud Print™, Brother iPrint+Scan and WiFi Direct™.

B BROTHER MFC-L3770CDW DIGITAL COLOUR ALL-IN-ONE WITH WIRELESS NETWORKING AND DUPLEX PRINTING

A perfect choice for home and small business looking for a fast, reliable all-in-one with duplex (2 sided) printing and the time-saving advantage of single pass duplex scanning and faxing. 3.7" touchscreen display. Wireless printing from your mobile devices.

ORDER NUMBER	DESCRIPTION	UNIT
TN223BK	Toner - Black	EA
TN223C	Toner - Cyan	EA
TN223M	Toner - Magenta	EA
TN223Y	Toner - Yellow	EA
TN227BK	Toner - Black, high yield	EA
TN227C	Toner - Cyan, high yield	EA
TN227M	Toner - Magenta, high yield	EA
TN227Y	Toner - Yellow, high yield	EA

ORDER NUMBER	DESCRIPTION	UNIT
TN223BK	Toner - Black	EA
TN223C	Toner - Cyan	EA
TN223M	Toner - Magenta	EA
TN223Y	Toner - Yellow	EA
TN227BK	Toner - Black, high yield	EA
TN227C	Toner - Cyan, high yield	EA
TN227M	Toner - Magenta, high yield	EA
TN227Y	Toner - Yellow, high yield	EA



C BROTHER MFC-L8610CDW COLOUR LASER MULTIFUNCTION PRINTER WITH WIRELESS NETWORKING AND DUPLEX PRINTING

Produces high-impact colour output at impressive print and copy speeds (up to 33ppm); offers flexible connectivity with USB and Ethernet interfaces. Automatic duplex printing.



D BROTHER MFC-L8900CDW COLOUR LASER ALL-IN-ONE WITH WIRELESS NETWORKING AND DUPLEX PRINTING

High-impact colour output at impressive print and copy speeds. 4.85" colour touchscreen display. Flexible connectivity. Advanced two-sided capability. USB direct interface.

ORDER NUMBER	DESCRIPTION	UNIT
TN431BK	Toner – Black	EA
TN431C	Toner – Cyan	EA
TN431M	Toner – Magenta	EA
TN431Y	Toner – Yellow	EA
DR431CL	Drum	EA

ORDER NUMBER	DESCRIPTION	UNIT
TN431BK	Toner – Black	EA
TN431C	Toner – Cyan	EA
TN431M	Toner – Magenta	EA
TN431Y	Toner – Yellow	EA
DR431CL	Drum	EA

ORDER NUMBER	MAX. SPEED BLK/COL. (PPM)	AUTO DOC. FEEDER	MAXIMUM PRINT RES. (DPI)	SHEET CAPACITY	FUNCTIONS				
					2-SIDED PRINT	SCAN (RES.)	MAX. COPY SPEED	FAX SPEED	CONNECTIVITY
A MFCL3710CW	19 / 19	50 Sheets	600×2400	250	Manual	19200×19200	19 cpm	33.6 Kbps	USB, W, b/g/n, WFD
B MFCL3770CDW	25 / 25	50 Sheets	600×2400	250	Automatic	19200×19200	25 cpm	33.6 Kbps	USB, Eth, W, b/g/n, WFD
C MFCL8610CDW	33 / 33	50 Sheets	2400×600	250	Automatic	19200×19200	33 cpm	33.6 Kbps	USB, Eth, W, b/g/n, WFD
D MFCL8900CDW	33 / 33	70 Sheets	2400×600	250	Automatic	19200×19200	33 cpm	33.6 Kbps	USB, Eth, W, b/g/n, WFD

Connectivity abbreviations: USB - Hi-speed USB 2.0; Eth - wired Ethernet; W, b/g/n - Wireless 802.11 b/g/n; PB - PictBridge; WFD-WiFi Direct

Printers – colour laser

NEW!



A LEXMARK™ CS331DW WIRELESS COLOUR PRINTER

Compact size and built-in energy saving mode.

ORDER NUMBER	DESCRIPTION	UNIT
20N10K0	Toner - Black, (return)	EA
20N10C0	Toner - Cyan, (return)	EA
20N10M0	Toner - Magenta, (return)	EA
20N10Y0	Toner - Yellow, (return)	EA



B BROTHER HL-L3270CDW WIRELESS DIGITAL COLOUR PRINTER

Mobile device printing. Fast, impactful colour for the small office.

ORDER NUMBER	DESCRIPTION	UNIT
TN223BK	Toner - Black	EA
TN223C	Toner - Cyan	EA
TN223M	Toner - Magenta	EA
TN223Y	Toner - Yellow	EA
TN227BK	Toner - Black, high yield	EA
TN227C	Toner - Cyan, high yield	EA
TN227M	Toner - Magenta, high yield	EA
TN227Y	Toner - Yellow, high yield	EA

C CANON IMAGECLASS MF642CDW COLOUR LASER ALL-IN-ONE PRINTER

For small and medium-size businesses. Print, scan, and copy capabilities. A 5" colour touchscreen delivers an intuitive user experience and can be customized by a device administrator to simplify daily tasks.



ORDER NUMBER	DESCRIPTION	UNIT
3024C001	Toner - #054 Black	EA
3023C001	Toner - #054 Cyan	EA
3022C001	Toner - #054 Magenta	EA
3021C001	Toner - #054 Yellow	EA

D BROTHER HL-L8360CDW COLOUR LASER PRINTER WITH WIRELESS NETWORKING

USB interface for direct printing. Automatic two-sided printing.



ORDER NUMBER	DESCRIPTION	UNIT
TN431BK	Toner - Black	EA
TN431C	Toner - Cyan	EA
TN431M	Toner - Magenta	EA
TN431Y	Toner - Yellow	EA
DR431CL	Drum	EA



E HP® LASERJET PRO M255DW WIRELESS COLOUR LASER PRINTER

ePrint, AirPrint™. Automatic two-sided printing.

ORDER NUMBER	DESCRIPTION	UNIT
W2110A	Toner - #206A Black	EA
W2111A	Toner - #206A Cyan	EA
W2113A	Toner - #206A Magenta	EA
W2112A	Toner - #206A Yellow	EA

NEW!

F HP® LASERJET PRO M454DW PRINTER

Connect with versatile options including built-in wireless or USB interfaces and print wirelessly from mobile devices.



ORDER NUMBER	DESCRIPTION	UNIT
W2020A	Toner - Black	EA
W2021A	Toner - Cyan	EA
W2023A	Toner - Magenta	EA
W2022A	Toner - Yellow	EA

	ORDER NUMBER	MAX. PRINT SPEED (PPM)	MAXIMUM PRINT RES. (DPI)	SHEET CAPACITY	DUPLEX 2-SIDED PRINT	CONNECTIVITY	FIRST PAGE OUT SPEED	WARRANTY
A	40N9020	26/26	600×600	250	Automatic	USB, Eth, W, b/g/n, WFD	10.9 sec.	1-year limited
B	HLL3270CDW	25/25	1200×1200	250	Automatic	USB, W, b/g/n, WFD	14 sec.	1-year limited
C	3102C012	22/22	600×600	250	Automatic	USB, Eth, W, b/g/n, WFD	10.3 sec.	1-year
D	HLL8360CDW	33/33	2400×600	250	Automatic	USB, Eth, W, b/g/n, WFD	15 sec.	1-year limited, exchange
E	7KW64ABGJ	22/22	600×600	250	Automatic	USB, Eth, W, b/g/n, WFD	10.2 sec.	1-year limited, exchange
F	W1Y45ABGJ	28/28	600×600	250	Automatic	USB, W, b/g/n, WFD	9.3 sec.	1-year limited

Connectivity abbreviations: USB - Hi-speed USB 2.0; Eth - wired Ethernet; W, b/g/n - Wireless 802.11 b/g/n; PB - PictBridge; WFD - WiFi Direct



A BROTHER DCP-L2550DW COMPACT LASER MULTIFUNCTION COPIER

Print, copy, and scan. Features two-sided printing, 50 page auto document feeder, wireless networking and standalone copying.

ORDER NUMBER	DESCRIPTION	UNIT
TN730	Toner – Black	EA
TN760	Toner – Black – high yield	EA
DR730	Drum	EA



B BROTHER MFC-L2730DW MULTIFUNCTION LASER PRINTER

Print, copy, scan, and fax. Features two-sided printing, wireless networking and standalone copying.

ORDER NUMBER	DESCRIPTION	UNIT
TN730	Toner - Black	EA
TN760	Toner - Black, high yield	EA
DR730	Drum	EA



C BROTHER MFC-L5800DW MONOCHROME LASER ALL-IN-ONE PRINTER

Combines high-speed, reliable printing and copying (up to 40 ppm), high-quality colour scanning and faxing into one durable design. With automatic duplex printing and wireless networking.

ORDER NUMBER	DESCRIPTION	UNIT
TN820	Toner - Black (3000 p)	EA
TN850	Toner - Black, high yield	EA
DR820	Drum	EA



D BROTHER MFC-L5900DW MULTIFUNCTION LASER PRINTER

Combines high-speed, reliable printing and copying (up to 42 ppm), high-quality colour scanning and faxing into one durable design. With advanced duplex printing, Ethernet or wireless networking and printing from mobile devices.

ORDER NUMBER	DESCRIPTION	UNIT
TN820	Toner - Black (3000 p)	EA
TN850	Toner - Black, high yield	EA
DR820	Drum	EA



E CANON IMAGECLASS D1650 MONO LASER ALL-IN-ONE PRINTER

Designed for small to mid-size workgroups, it balances speedy performance, minimal maintenance, and the ability to expand paper capacity for busy groups. A 5" colour touchscreen delivers an intuitive user experience.

ORDER NUMBER	DESCRIPTION	UNIT
3252C001	Toner - Black, high yield	EA



F BROTHER MFC-L2750DW MULTIFUNCTION LASER PRINTER

Print, copy, scan and fax. Features two-sided printing, mobile device printing, wireless and wired networking, 50-page capacity automatic document feeder, and up to 36 ppm printing and copying.

ORDER NUMBER	DESCRIPTION	UNIT
TN730	Toner – Black	EA
TN760	Toner – Black, high yield	EA
DR730	Drum	EA

ORDER NUMBER	MAX. PRINT SPEED (PPM)	FIRST PAGE OUT SPEED	MAXIMUM PRINT RES. (DPI)	SHEET CAPACITY	FUNCTIONS				CONNECTIVITY
					2-SIDED PRINT	SCAN (RES.)	MAX. COPY SPEED	FAX SPEED	
A DCPL2550DW	36	8.5 sec.	2400×600	250	Yes	19200×19200	36 cpm	N/A	USB, Eth, W.b/g/n
B MFCL2730DW	36	8.5 sec.	2400×600	250	Yes	19200×19200	36 cpm	33.6 Kbps	USB, Eth, W.b/g/n, WFD
C MFCL5800DW	42	7.2 sec.	1200×1200	250	Yes	19200×19200	42 cpm	33.6 Kbps	USB, Eth, W.b/g/n, WFD
D MFCL5900DW	42	7.2 sec.	1200×1200	250	Yes	19200×19200	42 cpm	33.6 Kbps	USB, Eth, W.b/g/n, WFD
E 2223C023	45	6.2 sec.	600×600	650	Yes	600×600	45 cpm	33.6 Kbps	USB, Eth, W.b/g/n, WFD
F MFCL2750DW	36	8.5 sec.	2400×600	250	Yes	19200×19200	36 cpm	33.6 Kbps	Eth, W.b/g/n, WFD

Connectivity abbreviations: USB - Hi-speed USB 2.0; Eth - wired Ethernet; W. b/g/n - Wireless 802.11 b/g/n; PB - PictBridge; WFD-WiFi Direct

Printers – monochrome laser

A BROTHER MFC-L6700DW MULTIFUNCTION CENTRE

Offers reliable print, copy, scan and fax functions. Touch-screen convenience and mobile device printing. Network printing/scanning/PC-FAX send and receive.

ORDER NUMBER	DESCRIPTION	UNIT
TN820	Toner - Black (3000 p)	EA
TN850	Toner - Black, high yield	EA
DR820	Drum	EA

NEW!
B LEXMARK® MX431ADW MONOCHROME LASER PRINTER

Multifunction builds on outstanding performance with standard Wi-Fi. Get output up to 42 pages per minute, plus double-side automatic scanning, copying, faxing and touch-screen convenience.

ORDER NUMBER	DESCRIPTION	UNIT
51B1X00	Toner - Black	EA

NEW!
C HP® LASERJET PRO MFP4101FDW WIRELESS PRINTER

Print, scan, copy and fax. Increase productivity with reliable, automatic duplex printing and fast print speeds. Print from smartphones, tablets, or laptops with mobile printing options.

ORDER NUMBER	DESCRIPTION	UNIT
W1480A	Toner - #148A Black	EA

D HP+ LASERJET MFP M234SDWE PRINTER

Exclusive use of HP Original ink/toner required. Print, copy, scan. Supports Apple AirPrint™; HP Smart App; Mopria™ Certified; Wi-Fi® Direct Printing. Auto duplex printing. Comes with 6 months of free toner with HP instant ink and 2-year extended warranty when you activate HP+ with an account and internet connection.

ORDER NUMBER	DESCRIPTION	UNIT
W1340A	Toner - #134A Black	EA
W1340X	Toner - #134X Black, high yield	EA

NEW!
E HP® LASERJET PRO 3001DW WIRELESS MONOCHROME PRINTER

This printer is built with powerful productivity features for small teams - fast speeds, built-in security, and cloud connectivity so you can setup and manage it from anywhere.

ORDER NUMBER	DESCRIPTION	UNIT
W1380A	Toner - #138A Black	EA
W1380X	Toner - #138X Black, high yield	EA

	ORDER NUMBER	MAX. PRINT SPEED (PPM)	FIRST PAGE OUT SPEED	MAXIMUM PRINT RES. (DPI)	SHEET CAPACITY	FUNCTIONS				CONNECTIVITY	WARRANTY
						2-SIDED PRINT	SCAN (RES.)	MAX. COPY	FAX SPEED		
A	MFCL6700DW	48	7.5 sec.	1200×1200	520	Automatic	1200×1200	48cpm	33.6 Kbps	USB, Eth, W. b/g/n, WFD	1-year limited
B	29S0500	42	5.9 sec.	600×600	350	Automatic	600×600	40cpm	33.6 Kbps	USB, Eth, W. b/g/n	1-year exchange
C	2Z619FBGJ	40	6.1 sec.	1200×1200	250	Automatic	1200×1200	40cpm		USB, Eth, W. b/g/n, WFD	1-year limited
D	6GX01EBGJ	30	6.9 sec.	600×600	150	Automatic	600×600	30 cpm		USB, Eth, W. b/g/n, WFD	2-year limited
E	3G650FBGJ	35	6.6 sec.	1200×1200	250	Automatic				USB, Eth, W. b/g/n, WFD	1-year limited

Connectivity abbreviations: USB - Hi-speed USB 2.0; Eth - wired Ethernet; W. b/g/n - Wireless 802.11 b/g/n; PB - PictBridge; WFD - WiFi Direct



A HP® LASERJET MFP M234DW PRINTER

Accepts remanufactured and compatible cartridges. Print, copy, scan. Duplex printing. 1-year limited warranty.

ORDER NUMBER	DESCRIPTION	UNIT
W1340A	Toner - #134A Black	EA
W1340X	Toner - #134X Black, high yield	EA



B HP+ LASERJET MFP M234DWE PRINTER

Exclusive use of HP Original ink/toner required. Print, copy, scan. Auto duplex printing. Comes with 6 months of free toner with HP instant ink and 2-year extended warranty when you activate HP+ with an account and internet connection.

ORDER NUMBER	DESCRIPTION	UNIT
W1340A	Toner - #134A Black	EA
W1340X	Toner - #134X Black, high yield	EA



C BROTHER HL-L2320D COMPACT MONOCHROME LASER PRINTER

Monochrome laser printer; provides fast printing high quality output, and two-sided printing.

ORDER NUMBER	DESCRIPTION	UNIT
TN630	Toner - Black	EA
TN660	Toner - Black - high yield	EA
DR630	Drum	EA



D LEXMARK® MS331DN MONOCHROME LASER PRINTER

40 ppm black. 600 × 600 dpi. 1-GHz dual-core processor. 2-line All Points Addressable (APA) monochrome LCD display. 256 MB memory. Integrated Duplex Printing. 1-year advanced exchange warranty.

ORDER NUMBER	DESCRIPTION	UNIT
55B1000	Toner - Black	EA
55B1H00	Toner - Black, high yield	EA



E HP+ LASERJET M209DWE MONOCHROME LASER PRINTER

Exclusive use of HP Original ink/toner required. HP Smart App, Apple AirPrint™, Mopria™ Certified. Comes with 6 months of free toner with HP instant ink and 2-year extended warranty when you activate HP+ with an account and internet connection.

ORDER NUMBER	DESCRIPTION	UNIT
W1340A	Toner - #134A Black	EA
W1340X	Toner - #134X Black, high yield	EA



F HP® LASERJET M209DW MONOCHROME LASER PRINTER

Accepts remanufactured and compatible cartridges. Apple AirPrint™, HP Smart App, Mopria™ Certified, Wi-Fi® Direct printing. 1-year warranty.

ORDER NUMBER	DESCRIPTION	UNIT
W1340A	Toner - #134A Black	EA
W1340X	Toner - #134X Black, high yield	EA

	ORDER NUMBER	MAX. PRINT SPEED (PPM)	FIRST PAGE OUT SPEED	MAXIMUM PRINT RES. (DPI)	SHEET CAPACITY	DUPLEX 2-SIDED PRINT	SCAN (RES.)	MAXIMUM COPY SPEED	CONNECTIVITY	WARRANTY
A	6GW99FBGJ	30	6.9 sec.	600×600	150	Automatic	600×600	30 cpm	USB,Eth,W.b/g/n,WFD	1-year limited
B	6GW99EBGJ	30	6.9 sec.	600×600	150	Automatic	600×600	30 cpm	USB,Eth,W.b/g/n,WFD	2-year limited
C	HLL2320D	30	8.5 sec.	2400×600	250	Automatic			USB	1-year limited
D	29S0000	40	6.2 sec.	2400×600	150	Automatic			USB,Eth	1-year advanced exchange warranty
E	6GW62EBGJ	30	6.9 sec.	600×600	150	Automatic			USB,Eth,W.b/g/n,WFD	2-year limited
F	6GW62FBGJ	30	6.9 sec.	600×600	150	Automatic			USB,Eth,W.b/g/n,WFD	1-year limited

Connectivity abbreviations: USB - Hi-speed USB 2.0; Eth - wired Ethernet; W. b/g/n - Wireless 802.11 b/g/n; PB - PictBridge; WFD-WiFi Direct

Printers – monochrome laser



A HP® LASERJET PRO 4001DW MONOCHROME PRINTER

This printer is built for maximum productivity with fast speeds and reliable hardware, delivering effortless everyday use from wherever work happens so you can focus more on your business.

ORDER NUMBER	DESCRIPTION	UNIT
W1480A	Toner - #148A Black	EA



B BROTHER HL-L2370DW COMPACT MONOCHROME LASER PRINTER

Home office printer provides high quality output; USB 2.0 Interface; two-sided printing and wireless networking.

ORDER NUMBER	DESCRIPTION	UNIT
TN630	Toner - Black	EA
TN660	Toner - Black - high yield	EA
DR630	Drum	EA



C HP® LASERJET PRO 4001DN MONOCHROME PRINTER

This printer is built for maximum productivity with fast speeds and reliable hardware, delivering effortless everyday use from wherever work happens so you can focus more on your business.

ORDER NUMBER	DESCRIPTION	UNIT
W1480A	Toner - #148A Black	EA



D BROTHER HL-L5000D MONOCHROME LASER PRINTER

High-speed printer for small to medium sized businesses; offers flexible local connectivity.

ORDER NUMBER	DESCRIPTION	UNIT
TN820	Toner - Black (3000 p)	EA
TN850	Toner - Black, high yield	EA
DR820	Drum	EA



E BROTHER HL-L5200DW DUPLEX WIRELESS MONOCHROME LASER PRINTER

A cost efficient, reliable laser printer for busy offices and small work groups. Print wirelessly from mobile devices.

ORDER NUMBER	DESCRIPTION	UNIT
TN820	Toner - Black (3000 p)	EA
TN850	Toner - Black, high yield	EA
DR820	Drum	EA



F BROTHER HL-L6200DW DUPLEX WIRELESS BUSINESS MONO LASER PRINTER

The ultimate high volume monochrome laser printer for medium sized businesses and small work groups. Print wirelessly from mobile devices.

ORDER NUMBER	DESCRIPTION	UNIT
TN820	Toner - Black (3000 p)	EA
TN850	Toner - Black, high yield	EA
DR820	Drum	EA

	ORDER NUMBER	MAX. PRINT SPEED (PPM)	FIRST PAGE OUT SPEED	MAXIMUM PRINT RES. (DPI)	SHEET CAPACITY	DUPLEX 2-SIDED PRINT	CONNECTIVITY	WARRANTY
A	2Z601FBGJ	40	6.1 sec.	1200×1200	350	Automatic	USB, Eth, W.b/g/n, WFD	1-year limited
B	HLL2370DW	32	8.5 sec.	2400×600	250	Automatic	USB, Eth, W.b/g/n, WFD	1-year limited
C	2Z600FBGJ	40	6.1 sec.	1200×1200	350	Automatic	USB, Eth	1-year limited
D	HLL5000D	42	7.2 sec.	1200×1200	250	Automatic	USB, Parallel	1-year limited
E	HLL5200DW	42	7.2 sec.	1200×1200	250	Automatic	USB, Eth, W.b/g/n, WFD	1-year limited
F	HLL6200DW	48	7.5 sec.	1200×1200	520	Automatic	USB, Eth, W.b/g/n, WFD	1-year limited

Connectivity abbreviations: USB - Hi-speed USB 2.0; Eth - wired Ethernet; W. b/g/n - Wireless 802.11 b/g/n; PB - PictBridge; WFD - WiFi Direct

NEW!



A BROTHER MFC-J5855DW INKVESTMENT TANK COLOUR ALL-IN-ONE PRINTER

The eco-friendly inkjet all-in-one with advanced triple layer security is perfect for home office or small business use. Print, copy, scan, and fax from a computer, mobile device, or from its 3.5 LCD colour touchscreen. Prints up to 11" x 17".

ORDER NUMBER	DESCRIPTION	UNIT
LC406BKS	Inkjet- Black	EA
LC406CS	Inkjet- Cyan	EA
LC406MS	Inkjet- Magenta	EA
LC406YS	Inkjet- Yellow	EA

NEW!



B CANON® PIXMA G3260 WIRELESS MEGATANK ALL-IN- ONE PRINTER

Delivers high-volume, low-cost printing. Its refillable MegaTank ink system prints up to 6,000 black/ 7,700 colour pages from one set of ink bottles. Print, copy, and scan with ease.

ORDER NUMBER	DESCRIPTION	UNIT
3383C001	Ink- Black	EA
3394C001	Ink - Cyan	EA
3395C001	Ink - Magenta	EA
3396C001	Ink - Yellow	EA

NEW!



C BROTHER MFC-J4535DW INKVESTMENT TANK COLOUR ALL-IN-ONE PRINTER

Ideal for home and small office use. Its reengineered high-capacity in-box ink cartridges provide up to 1-year of uninterrupted printing. Print and copy from your mobile device plus scan and fax.

ORDER NUMBER	DESCRIPTION	UNIT
LC406BKS	Inkjet- Black	EA
LC406CS	Inkjet- Cyan	EA
LC406MS	Inkjet- Magenta	EA
LC406YS	Inkjet- Yellow	EA

NEW!



D CANON PIXMA TR4720 WIRELESS ALL-IN-ONE PRINTER

For all your work or home printing needs. Enjoy simple setup and an easy to install 2-Cartridge hybrid ink system. Print, copy, scan and fax.

ORDER NUMBER	DESCRIPTION	UNIT
PG275	Inkjet- Black	EA
CL276	Inkjet- Colour	EA

E BROTHER MFC-J1010DW WIRELESS COLOUR INKJET ALL-IN-ONE PRINTER

This all-in-one has fast print speeds, business features and flexible connectivity, for home, home office or small office use. Compact and economical, it offers wired and wireless connection, flexible paper handling and Brother Page Gauge.

ORDER NUMBER	DESCRIPTION	UNIT
LC401BKS	Inkjet- Black	EA
LC401CS	Inkjet- Cyan	EA
LC401MS	Inkjet- Magenta	EA
LC401YS	Inkjet- Yellow	EA

NEW!



	ORDER NUMBER	MAX. PRINT SPEED (PPM)	MAXIMUM PRINT RES. (DPI)	SHEET CAPACITY	2-SIDED PRINT	FUNCTIONS SCAN (RES.)	FAX SPEED	CONNECTIVITY	WARRANTY
A	MFCJ5855DW	30 / 30	4800x1200	250	Automatic	1200x1200	33.6 Kbps	USB,ETH,W.b/g/n,WFD,PB	2-year limited
B	4468C003	10.8 / 6.0	4800x1200	100	Automatic	600x1200		USB, W.b/g/n,WFD	1-year limited
C	MFCJ4535DW	20 / 19	4800x1200	400	Automatic	2400x1200	14.4 Kbps	USB,ETH,W.b/g/n,WFD	2-year limited
D	5074C003	8.8 / 4.4	4800x1200	100	Automatic	600x1200	33.6 Kbps	USB, W.b/g/n,WFD	1-year limited
E	MFCJ1010DW	17 / 9.5	6000x1200	150	Automatic	2400x1200	14.4 Kbps	USB,ETH,W.b/g/n,WFD	1-year limited

Connectivity abbreviations: USB - Hi-speed USB 2.0; Eth - wired Ethernet; W. b/g/n - Wireless 802.11 b/g/n; PB - PictBridge; WFD-WiFi Direct

Printers – inkjet

A HP® OFFICEJET PRO 9015e ALL-IN-ONE PRINTER

A revolutionary smart printer. Saves time with Smart Tasks shortcuts and automatic 2-sided scanning, easy mobile printing, seamless connections, and best-in-class security.



ORDER NUMBER	DESCRIPTION	UNIT
3HZ99AN140	Inkjet - #962 Black	EA
3HZ96AN140	Inkjet - #962 Cyan	EA
3HZ97AN140	Inkjet - #962 Magenta	EA
3HZ98AN140	Inkjet - #962 Yellow	EA

B HP® OFFICEJET PRO 9020 ALL-IN-ONE PRINTER

Print, copy, scan and fax. Print directly from USB. 2.65" touch screen control panel. Automatic two-sided printing. Self-healing Wi-Fi™ keeps you connected.



ORDER NUMBER	DESCRIPTION	UNIT
3HZ99AN140	Inkjet - #962 Black	EA
3HZ96AN140	Inkjet - #962 Cyan	EA
3HZ97AN140	Inkjet - #962 Magenta	EA
3HZ98AN140	Inkjet - #962 Yellow	EA

C CANON MAXIFY MB2120 BUSINESS ALL-IN-ONE PRINTER

Print, scan, copy, fax. 19 ISO ppm black, 13 ISO ppm colour. 600×1200 dpi. First page out in 6 seconds. USB, Wireless. 250 sheet tray.



ORDER NUMBER	DESCRIPTION	UNIT
PGI1200XLBK	Inkjet - #1200XL Black	2/PK
9183B008	Inkjet - #1200XL Colour	4/PK
PGI1200BK	Inkjet - #1200 Black	EA
PGI1200C	Inkjet - #1200 Cyan	EA
PGI1200M	Inkjet - #1200 Magenta	EA
PGI1200Y	Inkjet - #1200 Yellow	EA

NEW!

D CANON TR7620A WIRELESS COLOUR ALL-IN-ONE INKJET PRINTER

Print, copy, scan, fax. 15 ISO ppm black, 10 ISO ppm colour. 4800×1200 dpi printer. Hi-Speed USB, PictBridge Wireless LAN, Wi-Fi b/g/n, Bluetooth. 3" LCD touchscreen. 100-sheet tray.



ORDER NUMBER	DESCRIPTION	UNIT
PGI280	Inkjet - #280 Black	EA
PGI280XL	Inkjet - #280XL Black, high yield	EA
CLI281BK	Inkjet - #281 Black	EA
CLI281C	Inkjet - #281 Cyan	EA
CLI281M	Inkjet - #281 Magenta	EA
CLI281Y	Inkjet - #281 Yellow	EA

E CANON PIXMA G6020 WIRELESS MEGATANK COLOUR ALL-IN-ONE INKJET PRINTER

Print, copy, scan. 13 ISO ppm black, 6.8 ISO ppm colour. 4800×1200 dpi. First page out in 9 seconds. Hi-Speed USB, PictBridge Wireless LAN, Wi-Fi b/g/n. Features 4 individual MegaTank refillable inks. 100-sheet letter tray.



ORDER NUMBER	DESCRIPTION	UNIT
3383C001	Ink - Black	EA
3394C001	Ink - Cyan	EA
3395C001	Ink - Magenta	EA
3396C001	Ink - Yellow	EA

F CANON PIXMA TS9520 WIRELESS COLOUR ALL-IN-ONE INKJET PRINTER

Print, copy, scan. 15 ISO ppm colour. 4800×1200 dpi. Hi-Speed USB, PictBridge Wireless LAN, Wi-Fi b/g/n, Bluetooth. 11"×17" printing, Memory card slot and 4.3" LCD touchscreen. 100-sheet letter tray.



ORDER NUMBER	DESCRIPTION	UNIT
PGI280	Inkjet - #280 Black	EA
PGI280XL	Inkjet - #280XL Black, high yield	EA
CLI281BK	Inkjet - #281 Black	EA
CLI281C	Inkjet - #281 Cyan	EA
CLI281M	Inkjet - #281 Magenta	EA
CLI281Y	Inkjet - #281 Yellow	EA

ORDER NUMBER	MAX. SPEED BLK/COL (PPM)	MAXIMUM PRINT RES. (DPI)	SHEET CAPACITY	FUNCTIONS			CONNECTIVITY	WARRANTY
				2-SIDED PRINT	SCAN (RES.)	FAX SPEED		
A 1G5L3AB1H	22 / 18	1200×1200	250	Automatic	1200×1200	33.6 Kbps	USB,Eth,W.b/g/n,WFD	1-year limited
B 1MR78AB1H	24 / 20	1200×1200	250	Automatic	1200×1200	33.6 Kbps	USB,Eth,W.b/g/n,WFD	1-year limited
C 0959C003	19 / 13	600×1200	250	Automatic	1200×1200	33.6 Kbps	USB,W.b/g/n,WFD	1-year limited
D 4452C023	15 / 10	4800×1200	100	Automatic	1200×2400	33.6 Kbps	USB,W.b/g/n,WFD,PB	1-year limited
E 3113C003	13 / 6.8	4800×1200	250	Automatic	1200×2400		USB,W.b/g/n,WFD,PB	1-year limited
F 2988C003	15 / 10	4800×1200	100	Automatic	1200×2400		USB,W.b/g/n,WFD,PB	1-year limited

Connectivity abbreviations: USB - Hi-speed USB 2.0; Eth - wired Ethernet; W. b/g/n - Wireless 802.11 b/g/n; PB - PictBridge; WFD-WiFi Direct



**A FUJITSU®
FI-7140 SCANNER**

Features 40 ppm / 80 ipm scanning in colour, grayscale and monochrome; 80-sheet Automatic Document Feeder (ADF); Embossed card scanning (1.4 mm thickness); Advanced paper handling technology for the ultimate in feeding reliability; LED light-source; Scanner Central Admin suite; and Comes with PaperStream IP (TWAIN/ISIS) and PaperStream Capture.

ORDER NUMBER	UNIT
PA03670-B105	EA



**B FUJITSU®
SCANSNAP
IX1400
SCANNER**

Scans 40 sheets per minute in colour-duplex mode. USB 3.2, 2.0 or 1.1 connection. 50-page ADF. Cleans up images without the need for rescanning with Streak Reduction. Compatible with PC or Mac.

ORDER NUMBER	UNIT
PA03820-B235	EA



**C FUJITSU®
SCANSNAP
IX1600 TOUCH
SCREEN
SCANNER**

Connect through Wi-Fi or USB cable, allowing for the most flexible placement options, while the intuitive 4.3" touch screen with simple icons makes organizing, saving and finding documents a snap. Scans up to 40 ppm. Scan directly to Microsoft® Word, Excel and Powerpoint® using ABBYY FineReader for ScanSnap™. 50-page ADF. Produces clean images using streak reduction. Compatible with PC or Mac.

ORDER NUMBER	UNIT
PA03770-B635	EA



E BROTHER PROFESSIONAL DESKTOP SCANNER

Single and double-sided scanning up to 40ppm. 4.3" colour touchscreen display. 80-page capacity auto document feeder. Ability to create up to 56 customizable shortcuts for one-touch scanning. Equipped USB 3.0, AirPrint® and Brother Mobile Connect. Energy Star® compliant and EPEAT® Silver rated.

ORDER NUMBER	UNIT
ADS4700DW	EA



**D CANON IMAGEFORMULA DR-C230 OFFICE
DOCUMENT SCANNER**

Easily convert paper-based documents into high-quality digital files. 30 ppm Simplex/ 60 ppm Duplex; Up to 600 dpi resolution. USB 2.0. 60-sheet ADF. 24-bit Colour Scanning. Compatible with Windows® 10, 8.1, Windows Server® 2012 R2, 2008 R2

ORDER NUMBER	UNIT
2646C002	EA



Business Travel – laptop bags and sleeves



A SWISSGEAR® NOTEBOOK CASE

Dedicated tablet pocket to hold iPad or e-reader. Padded laptop compartment, organizer for media devices and cables. Quick access front zip with top carry handle and adjustable shoulder strap. Back strap fits over luggage handles. Accommodates most 17.3" notebooks. 600D Polytex. 2.5 lbs. Black.

ORDER NUMBER	DESCRIPTION	UNIT
SWA0998 009	17"×4"×12"	EA



C SWISSGEAR® NOTEBOOK CASE

Carry case features a tablet pocket, a full organizer in the front compartment, a front document pocket and a back web strap to fit over an upright handle. Fits most 17.3" notebooks. Polyester. 1½ lbs. Black.

ORDER NUMBER	DESCRIPTION	UNIT
SWA0586L	17¾"×2¾"×14"	EA



E WENGER® SWISSGEAR® MESSENGER BAG

With padded compartment which holds most laptops up to 15.6". Also features large zippered pocket on front flap, full organizer under front flap, shoulder strap with deluxe shoulder pad and molded top carry handle. Sides expand for extra space. Black. 1.6 lbs.

ORDER NUMBER	DESCRIPTION	UNIT
SWA0506	17"×3½" Expandable to 7½"×13"	EA



B KENSINGTON® CONTOUR™ 2.0 BUSINESS LAPTOP BRIEFCASE

Padded notebook compartment with bottom cushion protects your laptop. Features a padded carry handle, laptop security compartment with puncture-resistant, lockable zipper, RFID security pocket, and laptop compartment with drop protection. Black.

ORDER NUMBER	DESCRIPTION	UNIT
1 K60386WW	For 15.6" laptops	EA
2 K60387WW	For 17" laptops	EA



D ROOTS® LAPTOP CASE WITH USB PORT

RFID blocking pocket to help protect your identity. External USB port for charging mobile devices on the go. Has a quick access front zip pocket and a front slash pocket. The padded compartment fits most 15.6" notebooks. Made of durable polyester. 2½ lbs. Grey.

ORDER NUMBER	DESCRIPTION	UNIT
RTS3401	15½"×3"×11½"	EA



F SWISSGEAR® DOUBLE GUSSET COMPUTER CASE

Made of durable 1680 denier ballistic polytex material. Padded notebook compartment fits most 15.6" laptops. Multi-pocket organizer. Quick loop back strap slides over luggage handle. Legal size file folder compartment. Shoulder strap. Black. 2.8 lbs.

ORDER NUMBER	DESCRIPTION	UNIT
SWA0907 009	16"×4"×12"	EA

Business Travel – laptop bags and sleeves



A SWISSGEAR® NOTEBOOK BAG

Featuring a vertical front zippered pocket, open top and back pockets with carrying handles and removable shoulder strap. Dedicated scratch resistant tablet and e-reader pocket. 1.6 lbs., fits 17.3" laptops. Black.

ORDER NUMBER	DESCRIPTION	UNIT
SWG0102	17"×2½"×13¼"	EA

B SWISSGEAR® SCAN SMART BUSINESS CASE

Scan Smart technology allows the bag to lay open flat for airport scanners. The back strap is designed to fit over the handles of most carry-ons. Features a padded laptop compartment, front zipper pocket, adjustable and removable shoulder strap and top carry handles. 1680-Denier Polytex®. 2.8 lbs., fits 17.3" laptops. Black.

ORDER NUMBER	DESCRIPTION	UNIT
SWA0915	16½"×6"×12½"	EA



C SWISSGEAR® LAPTOP CASE

Padded compartment and integrated USB port connection with dedicated portable charger pocket. Comfortable wrapped double handles, adjustable shoulder strap, quick loop back strap to slide easily over retractable handle system, RFID blocking pocket to prevent identity theft. Accommodates most 15.6" laptops and 7" tablet. Grey.

ORDER NUMBER	DESCRIPTION	UNIT
SWA5132 005	15½"×3"×11½"	EA



D TARGUS® TOPLOAD CITYSMART PRO LAPTOP CASE

Featuring an innovative Multi-Fit cradle in the padded laptop compartment, which can securely accommodate a range of different sized hardware, this laptop briefcase is designed to carry and protect laptops between 14 and 15.6" with a reassuringly snug fit. Dedicated file section plus pockets and compartments for accessories. Padded adjustable shoulder strap ensures comfort while carrying.



ORDER NUMBER	DESCRIPTION	UNIT
TBT915CA	16"×3¼"×14½"	EA



E SWISSGEAR® NOTEBOOK CASE WITH TABLET POCKET

Dedicated tablet pocket holds an iPad or an e-reader. Interior pockets in the main compartment, front zipper pocket, top carry handles and an adjustable and removable shoulder strap. Accommodates most 17.3" notebooks. 1680-denier polyester. Black.

ORDER NUMBER	DESCRIPTION	UNIT
SWA0918 009	16½"W×6"D×11½"H	EA



F SWISSGEAR® SLIM NOTEBOOK BAG

Dedicated portable charger pocket to conveniently charge electronic devices on-the-go. Adjustable and detachable shoulder strap with non-slip shoulder pad. Quick-loop back strap fits over retractable handle system. Accommodates most 15.6" notebooks. Polyester. 1.4 lbs. Black.

ORDER NUMBER	DESCRIPTION	UNIT
SWA0936D 009	15½"×2½"×12"	EA

Business Travel – laptop bags and sleeves



A ROOTS® 3-COMPARTMENT BUSINESS COMPUTER SACHEL

Centre zipper and double magnetic snap top closure with silver tone hardware. Front flap pocket. Padded compartment for computer. Luggage slide feature on back panel with zipper slider that can be converted into a pocket. Double flat hand and detachable and adjustable shoulder strap. Accommodates most 17.3" notebooks. Poly synthetic.

ORDER NUMBER	DESCRIPTION	UNIT
R5739 009	18"W×4¼"D×11¾"H	EA



B ROOTS® 2 COMPARTMENT BUSINESS SACHEL

2 compartment business computer satchel with top zipper closure, silver tone hardware and faux leather trim. Features a padded centre computer compartment, wall zipper and two slip pockets. Textured polyester.

ORDER NUMBER	DESCRIPTION	UNIT
1 R4821N 009	15"×4¼"×14", Black	EA
2 R4821N 005	15"×4¼"×14", Grey	EA



C SWISSGEAR® LAPTOP TOTE

Quick-access front zip pocket, convenient pocket for cell phone or other media, quick-loop back strap fits over retractable handle systems and comfortable double handle fit easily over the shoulder. Padded compartment holds up to 14" laptop. Black with Rose Gold.

ORDER NUMBER	DESCRIPTION	UNIT
SWA5148 009	15"×2½"×11½"	EA



D WENGER® SWISSGEAR® 15.6" NEOPRENE SLEEVE WITH CABLE POCKET

Fits most laptops up to 15.6". Front zippered pocket with organizer and multiple pockets. Black. 0.7 lbs.

ORDER NUMBER	DESCRIPTION	UNIT
SWA0927H	15¼"×1"×11¼"	EA



E SWISSGEAR® NOTEBOOK/TABLET SLEEVE

Quick access front zip pocket and comfortable double handles. Lockable zipper pullers can help keep contents safe from pickpockets by hooking your own lock through pullers. Accommodates most 15.6" notebooks. Black/Grey.

ORDER NUMBER	DESCRIPTION	UNIT
SWC0171 195	15"W×1"D×11½"H	EA



F SWISSGEAR® NOTEBOOK ORGANIZER SLEEVE

Padded compartment and non-scratch lining. Multifunctional front quick access pockets to store table, mouse, charger, cables and other accessories. Fits most 13.3" notebooks Grey.

ORDER NUMBER	DESCRIPTION	UNIT
SWC0172 005	14"×¾"×10"	EA



A SWISSGEAR® COMPUTER BACKPACK ON WHEELS

In-line corner wheels with ball bearings for easy mobility. Features top carry handle, adjustable backpack straps, push button locking retractable mono handle, organizer in front pocket, 2 large front zipper pockets and side water bottle pockets. Accommodates most 15.6" notebooks. 600-denier polyester. 5 lbs. Black.

ORDER NUMBER	DESCRIPTION	UNIT
SWA0961R 009	13½"×8½"×20"	EA



B SWISSGEAR® SLING BAG WITH RFID PROTECTION

RFID blocking pocket can help prevent high-tech identity thieves from stealing personal information stored on microchips in passports and credit cards. Integrated 3-digit combination lock helps ensure peace of mind. Large main compartment. Adjustable strap for use on right or left side. 0.8 lbs. Grey.



ORDER NUMBER	DESCRIPTION	UNIT
SWT0609 005	8"×4"×12¼"	EA



C SWISSGEAR® NOTEBOOK BACKPACK

Features a unique zippered side-entry padded compartment dedicated to laptops up to 17" and tablet sleeve. Includes padded back & adjustable shoulder straps with breathable mesh lining, two mesh side pockets for water bottles or sundries, a comfortable carry handle, and a reflective accent for added safety. 1.8 lbs. Black.

ORDER NUMBER	DESCRIPTION	UNIT
SWA2402 009	12½"×9"×18¾"	EA



D SWISSGEAR® DENIM BUSINESS BACKPACK

Special pocket fits most tablets in their protective sleeve. Multi-use built-in organizer pockets, key FOB to find them easily. Multiple compartments and lots of storage. Airflow back system allows a better air circulation. Accommodates most 15.6" notebooks. Polyester. 1.7 lbs. Navy.

ORDER NUMBER	DESCRIPTION	UNIT
SWA2501BD 088	13¾"×7½"×18¾"	EA



E SWISSGEAR® NOTEBOOK BACKPACK

Special pocket fits most tablets in their protective sleeve. File folder pockets to easily organize documents. Multiple compartments provide high-capacity storage. Side zippered pocket for quick access to small items. RFID-blocking pocket helps prevent high-tech identity theft. Convenient pocket for cell phone or other media devices on shoulder strap. Lockable zippers. Reinforced bottom and practical top carry handle. Back mesh panel allows bag to slide easily over luggage handle. Accommodates most 17.3" notebooks. 1680 denier polyester. 2.9 lbs. Black.

ORDER NUMBER	DESCRIPTION	UNIT
SWA2328BD 009	14¼"×7"×18"	EA



F SWISSGEAR® SWA2536 BACKPACK

Integrated USB port, special pocket fits most tablets with protective sleeve, multi-use built-in organizer, side mesh pockets, RFID-blocking pocket, lockable zippers and practical top carrying handle. Comfortable padded back and adjustable shoulder straps. 1680 denier polyester. Fits most 15.6" laptops. Black.

ORDER NUMBER	DESCRIPTION	UNIT
SWA2536 009	13½"W×6½"S D×19½"S H	EA

Business Travel – attaché and wheeled cases



A MANCINI LEATHER EXPANDABLE ATTACHÉ CASE

Stylish and functional with a multitude of pockets and sections for organization. Two combination locks and soft suede leather lining. Black leather. 6.7 lbs.

ORDER NUMBER	DESCRIPTION	UNIT
86460-BK	17¾"×4¾"×13"	EA



B NEXTECH™ ABS ATTACHE CASE

ABS construction; adjustable padded compartment fits most notebooks up to 17"; deluxe organizer; file folder compartment. Black with silver trim. 3 lbs.

ORDER NUMBER	DESCRIPTION	UNIT
NT0916A 009	17½"×5"×12½"	EA



C BUGATTI ATTACHÉ CASE

Multi-use built-in organizer pockets with adjustable divider pockets. Reinforced handle and dual combination locks. Accommodates most 17.3" notebooks. Made of smooth vegan leather, with polyester lining. Black.

ORDER NUMBER	DESCRIPTION	UNIT
ATC2030-BLACK	17½"×4½"×13"	EA



D BUGATTI WHEELED BUSINESS CASE

Inline corner wheels. Back zipper compartment with three file dividers plus a section for overnight clothing. Zippered front pockets, reinforced, telescopic handle. Stabilizing front panel and back webbing for trolley pass-through. Accommodates most 17.3" notebooks. Two-tone resistant polyester with rubber trim. Charcoal.

ORDER NUMBER	DESCRIPTION	UNIT
BZCW301-BLACK	18¼"×9½"×15½"	EA



E SWISSGEAR® LAPTOP SPINNER WITH USB PORT

Spin 360°. 4-wheel system allows case to move easily in all directions. Dedicated portal charger pocket to conveniently charge electronic devices on-the-go. Retractable push-button handle locks into place when extended. Multi-use organizer. 1680-denier polyester. Accommodates most 15.6" notebooks. 7.5 lbs. Black.

ORDER NUMBER	DESCRIPTION	UNIT
SWA5176R 009	16½"×9½"×17"	EA



F SWISSGEAR® WHEELED BUSINESS CASE

In-line corner wheels with ball bearings ensure easy mobility. Features push button locking and retractable handle, front pocket with an organizer and a hidden ID on back panel. Accommodates most 15.6" notebooks. 600-denier polyester. 6 lbs. Black.

ORDER NUMBER	DESCRIPTION	UNIT
SWA0970 009	16½"×8½"×14"	EA



A NEXTECH™ ROLLING CATALOGUE CASE

Durable case on rollers; four stage locking telescopic handle. With gusseted locking front pocket, three exterior front pockets and interior padded portable computer pouch which accommodates most laptops up to 15.6". Black.

ORDER NUMBER	DESCRIPTION	UNIT
1 SA0801	19"×8"×14", Vinyl, 8 lbs.	EA
2 NT0803 009	16½"×7"×13½", Leather, 3½ lbs.	EA



B MANCINI WHEELED CATALOGUE CASE

High-capacity wheeled catalog case featuring a removable padded laptop sleeve to ensure that your laptop is safe and secure. Equipped with a zippered front organizer and separate compartments designed for transporting documents, folders, product samples, and more. Features zippered front organizer and separate compartments for documents, folders and samples. Leather. Accommodates most 17" notebooks. Black.

ORDER NUMBER	DESCRIPTION	UNIT
90469-BK	17"×8½"×13"	EA



C BUGATTI SPINNER CASE

Maximum manoeuvrability in any direction with the double 360-degree spinner wheels. Precise control, smooth and quiet rolling telescopic trolley handle allows you to pull easily. Reinforced top handle. padded laptop section fits most 14.1" laptops. Hybrid (polyester and polypropylene). Black.

ORDER NUMBER	DESCRIPTION	UNIT
HLG4016BU-BLACK	14¼"×8½"×18"	EA

NEW!

D KENSINGTON® SECURETREK™ OVERNIGHT ROLLER

Hammerhead zipper pulls click into place for premium anti-theft security. Padded compartment, anti-puncture zipper and front workstation pocket. Accommodates most 17" laptops and 10" tablets. 840 denier twill outer material. 7.5 lbs. Black.



ORDER NUMBER	DESCRIPTION	UNIT
K98620WW	14"W×10½"D×21"H	EA



E SWISSGEAR® SION SPINNER CARRY-ON

Meets all Canadian carry-on standards. Lightweight construction allows for maximum packing. Spin 360° 4-wheel system allows luggage to move easily in all directions. Retractable push-button handle locks into place. Lined zippered pocket on interior of lid. Privacy pocket on inside main compartment. Durable ABS construction. 10-year limited warranty. Black.

ORDER NUMBER	DESCRIPTION	UNIT
SW35069 009	14¼"×9"×21½"	EA

NEW!

F AUSTIN HOUSE® FOLDABLE COMPACT CART

Convenient for carrying luggage, bags or boxes. Compact size when closed for easy transportation and storage. 3-stage push-button telescopic handle with steel tubes extend up 38". Steel axle with 2⁹/₁₀" wheels and shielded steel ball bearings. Heavy-duty charging base. Elastic cord with heavy-duty hook. Black.



ORDER NUMBER	DESCRIPTION	UNIT
AH32CC01 009	9½"W×17¾"D×3"H	EA

NEW!



A BENCH DUFFLE BAG

Lightweight for easy carrying. Features large main compartment, "U" top zippered opening and side zippered pocket for small items. Removable and adjustable shoulder strap, and comfortable Velcro® wrap-over double handles. Polyester. 1.1 lbs. 18 4/5"W×10 1/2"D×9 4/5"H. Black.

ORDER NUMBER	UNIT
BEN1001 009	EA

NEW!



B BUGATTI REBORN CONVERTIBLE DUFFLE BAG



Adjustable and removable padded backpack straps turn this duffle bag into a backpack for a 2-in-1 hybrid. Interior organizer section with zipper and slip pocket. Back zipper pocket with hidden trolley strap for your suitcase. RFID protection to keep your personal information secure. Interior wet pocket to keep your belongings dry. Integrated key leash and internal iPad/tablet pocket. Made from repurposed water bottles with vegan leather accents. 2.43 lbs. 11"W×18"D×11"H. Black.

ORDER NUMBER	UNIT
DUF2230BU-BLACK	EA

NEW!



C AUSTIN HOUSE PASSPORT CASE WITH RFID PROTECTION

RFID blocking technology provides improved security for passports with chips. Features 3 credit card slots and a passport pocket. Leather. 5 1/2"×4 1/4". Black.

ORDER NUMBER	UNIT
AH66PC01 009	EA

NEW!



D MERANGUE® SELF LAMINATING LUGGAGE TAGS

No laminating machine required. Just place your card down, remove the protective strip, press the film down and you're done. Includes loops and inserts. 4"×3 3/8".

ORDER NUMBER	UNIT
1026-7041-00-000	10/PK

NEW!



E SWISSGEAR® COOLER BAG

Keep hot and cool items separate with this lunch bag featuring two large, fully-insulated compartments. Made of durable polyester fabric, it also includes a U-shaped top zippered opening, and a practical top carry handle. 8"W×6"D×10"H. Black

ORDER NUMBER	UNIT
SWA1905D 009	EA

F KENSINGTON® INTERNATIONAL TRAVEL ADAPTER - GROUNDED

Engineered to safely power your devices. in more than 200 countries around the world. Higher Power Output safely supplies up to 1575W to the most popular travelling device companions, including laptops, smartphones, shavers and hair dryers. Includes a retractable 3-pole adapter to power laptops and other devices, and provides an internal fuse to protect connected devices from unexpected power surges. Dual 2.4A USB Ports provide the fastest charging available for two devices. 2-year limited warranty.



ORDER NUMBER	UNIT
K38238WW	EA

NEW!

G STARTECH DUAL-PORT USB CHARGER - INTERNATIONAL TRAVEL ADAPTER

This versatile travel charger ships with interchangeable power plugs that let you plug in and charge your devices nearly anywhere you go around the world. Plus, you can charge two of your devices at the same time. This dual-port USB wall charger lets you charge two mobile devices at once, using a single USB wall charger. Features 2.4A USB 2.0 port and 1A USB 2.0 port.



ORDER NUMBER	UNIT
USB2PACBK	EA

Business Travel – zippered binders



A CAMBRIDGE® WORKSTYLE PADFOLIO

Professional look with gold accents. Features slots for business cards, an expanding pocket for loose papers, and a pen loop. Zipper closure. Includes a writing pad. Letter size. Faux leather. Black.

ORDER NUMBER	DESCRIPTION	UNIT
43100-33202	12¾"H×10"W	EA



B WINNABLE® ZIPPERED PADFOLIO

Letter size. Features two interior document pockets and one exterior document pocket for extra storage. Black Koskin exterior with zippered closure; writing pad included.

ORDER NUMBER	DESCRIPTION	UNIT
30001WIN	13½"×10¼"×1"	EA

NEW!



C IT'S ACADEMIC FAUX LEATHER BINDER

The perfect organization tool you need for sorting your paperwork with a professional look. Features 1" D-rings and curved spine. Pen loop and business card holder. Black.

ORDER NUMBER	DESCRIPTION	UNIT
92875	11½"×2"×12 1/3"	EA



D WINNABLE® EXECUTIVE BINDER PORTFOLIO

Features 2 document pockets and a zippered closure. Includes writing pad. 1" rings. Letter size. Koskin. Black.

ORDER NUMBER	DESCRIPTION	UNIT
PF-237II	13½"×10½"×1½"	EA



E WINNABLE® LEATHER BINDER PORTFOLIO

Features an interior pocket, exterior document pocket and zippered closure. Includes writing pad. 1" rings. Letter size. Leather. Black.

ORDER NUMBER	DESCRIPTION	UNIT
PFL-237	13½"×11"×1½"	EA



F HILROY EXECUTIVE PROFESSIONAL BINDER

Professional binder with 1" double boosters ring. Features an expandable filing pocket, 2 document pockets, elastic pen loops, credit card slots, clear ID pocket, multi-function calculator and a 30 sheet ruled writing pad. 1" capacity. Black.

ORDER NUMBER	DESCRIPTION	UNIT
65800-29444	10¼"×13 3/8"	EA

Check online for the most current price.

Data Storage – flash drives

made for:
iPhone,
iPad, iPod



A VERBATIM™ STORE 'N' GO® DUAL USB 3.0 FLASH DRIVES FOR APPLE LIGHTNING DEVICES

Exchange files quickly and easily between Apple Lightning devices and USB-equipped PCs. Designed for Apple iPhone, iPad and iPod products with Apple Lightning ports. Use Verbatim's free Store 'n' Go app to transfer and view content. Limited lifetime warranty. Graphite.

ORDER NUMBER	DESCRIPTION	UNIT
1 49300	32 GB	EA
2 49301	64 GB	EA



C VERBATIM™ ERGO USB 3.0 DRIVES

Now with built-in Microban® antimicrobial protection that helps prevent the growth of bacteria. Ideal combination of in-hand comfort and trusted data storage technology. Easy one-piece design means there's no cap to lose. Compatible with Windows® only. Limited lifetime warranty. Blue.

ORDER NUMBER	DESCRIPTION	UNIT
1 70878	32 GB	EA
2 70879	64 GB	EA
3 70880	128 GB	EA



E EMTEC™ C410 COLOR MIX USB 2.0 FLASH DRIVES

Read speed up to 15MB/s. Write speed up to 5MB/s.

ORDER NUMBER	DESCRIPTION	UNIT
1 ECMMD16GC410	16 GB red	EA
2 ECMMD32GC410	32 GB blue	EA

F CARDINAL® HOLD IT!™ USB POCKETS

Resealable flap closure keeps contents secure. Adhesive backing. 2"×3 3/8".

ORDER NUMBER	UNIT
21140	6/PK



B VERBATIM™ STORE 'N' GO® DUAL USB 3.0 DRIVES FOR USB-C DEVICES

Now with built-in Microban® antimicrobial protection that helps prevent the growth of bacteria. Easily transfer or offload files from your USB-C compatible smartphone or tablet to the Dual USB flash drive. Features USB 3.0 connectivity for fast data transfer speeds. USB-C compatible. Limited lifetime warranty. Blue.

ORDER NUMBER	DESCRIPTION	UNIT
1 99153	16 GB, Type C	EA
2 99154	32 GB, Type C	EA
3 99155	64 GB, Type C	EA

NEW!



D VERBATIM™ TOUGHMAX™ USB DRIVES

Crush it, boil it, freeze it – the ToughMAX can take it all. Water resistant, crush resistant and temperature resistant, this drive protects against rough-and-tumble use for a variety of lifestyles. Proprietary KyronMAX™ material, used in fighter jets, increases durability without adding weight, creating a uniquely tough USB drive in a slim, stylish design. Limited lifetime warranty.

ORDER NUMBER	DESCRIPTION	UNIT
1 70000	16 GB	EA
2 99849	32 GB	EA



G EMTEC™ SLIDE USB FLASH DRIVES

Sliding system allows you to open or retract your drive in just one click.

ORDER NUMBER	DESCRIPTION	UNIT
--------------	-------------	------

EMTEC™ C450 SLIDE 2.0 USB FLASH DRIVES

Read speed up to 15 MB/s. Write speed up to 8 MB/s. Black.

1 ECMMD16GC452	16 GB	EA
2 ECMMD32GC452	32 GB	EA
3 ECMMD64GC452	64 GB	EA
4 ECMMD16GC452P5	16 GB, assorted colours	5/PK

EMTEC™ B250 SLIDE 3.0 USB FLASH DRIVES

Read speed up to 20 MB/s. Write speed up to 10 MB/s. Grey.

5 ECMMD16GB253	16 GB	EA
6 ECMMD32GB253	32 GB	EA
7 ECMMD64GB253	64 GB	EA
8 ECMMD128GB253	128 GB	EA



A VERBATIM™ STORE 'N' GO® V3 USB 3.0 DRIVES

Now with built-in Microban® antimicrobial protection that helps prevent the growth of bacteria. Offers up to 10X faster data transfer speeds versus USB 2.0. Retractable housing, cap-less design. Limited Lifetime Warranty.

ORDER NUMBER	DESCRIPTION	UNIT
1 49172	16 GB, Grey	EA
2 49176	16 GB, Blue	EA
3 49173	32 GB, Grey	EA
4 49174	64 GB, Grey	EA
5 49189	128 GB, Grey	EA
6 49168	256 GB, Grey	EA



NEW!

B EMTEC™ CLICK EASY 3.2 USB FLASH DRIVES

In one click, open or retract your drive. Colourful and great performance, the ideal flash drive for daily use. Read speed up to 20 MB/s. Write speed up to 10 MB/s.

ORDER NUMBER	DESCRIPTION	UNIT
1 ECMMD64GB113	64 GB	EA
2 ECMMD128GB113	128 GB	EA
3 ECMMD256GB113	256 GB	EA
4 ECMMD512GB113	512 GB	EA



C VERBATIM™ STORE 'N' GO® USB 2.0 DRIVES

Now with built-in Microban® antimicrobial protection that helps prevent the growth of bacteria. Retractable design eliminates the hassle of caps. Limited Lifetime Warranty.

ORDER NUMBER	DESCRIPTION	UNIT
1 96317	16 GB	EA
2 96806	32 GB	EA
3 97005	64 GB	EA
4 98525	128 GB	EA
5 99810	NEW! 16 GB, Blue	5/PK
6 99811	NEW! 32 GB, Red, Blue, Green	3/PK
7 70893	NEW! 32 GB, Black	10/PK



D VERBATIM™ STORE 'N' GO® SECURE PRO USB 3.0 DRIVES WITH AES 256 HARDWARE ENCRYPTION

Retractable. Once configured with your password, all stored data is encrypted with powerful hardware-based 256-bit AES encryption to prevent unauthorized access. USB 3.0. Security features are compatible with both Windows and Mac OS. Silver. Limited Lifetime Warranty.

ORDER NUMBER	DESCRIPTION	UNIT
1 98664	16 GB	EA
2 98665	32 GB	EA
3 98666	64 GB	EA

NEW!



E KINGSTON® DATATRAVELER EXODIA USB 3.2 GEN 1 DRIVES

Allows quick transfers and convenient storage of documents, music, videos and more. Practical design and fashionable colours make it ideal for work, home, school. Features backward compatibility with USB 2.0 ports, cap protection, large colourful loop for portability. 5-year warranty.

ORDER NUMBER	DESCRIPTION	UNIT
1 DTX/32GBCR	32 GB	EA
2 DTX/64GBCR	64 GB	EA
3 DTX/128GBCR	128 GB	EA
4 DTX/256GBCR	256 GB	EA



F VERBATIM™ METAL EXECUTIVE USB FLASH DRIVE

Features a seamless, high-quality metal enclosure with fully encapsulated Chip On Board (COB) technology for water resistance and enhanced reliability. Includes keyring for added convenience. Limited Lifetime Warranty.



ORDER NUMBER	DESCRIPTION	UNIT
SILVER, USB 2.0		
1 98748	16 GB	EA
2 98749	32 GB	EA
3 98750	64 GB	EA
GOLD, USB 3.0		
4 99104	16 GB	EA
5 99105	32 GB	EA
6 99106	64 GB	EA

Data Storage – memory cards



A VERBATIM™ MICRO SD® CARDS WITH ADAPTOR

UHS-I, V10, U1, Class 10. High performance mobile solution with video capture/playback and fast photo upload/downloads. UHS-I interface compatible for fast read/write performance. Limited lifetime warranty. Includes adaptor for use in SDHC® card slot.

ORDER NUMBER	DESCRIPTION	UNIT
1 44082	16 GB, SDHC	EA
2 44083	32 GB, SDHC	EA
3 44084	64 GB, with SDXC adapter	EA
4 44085	128 GB, with SDXC adapter	EA

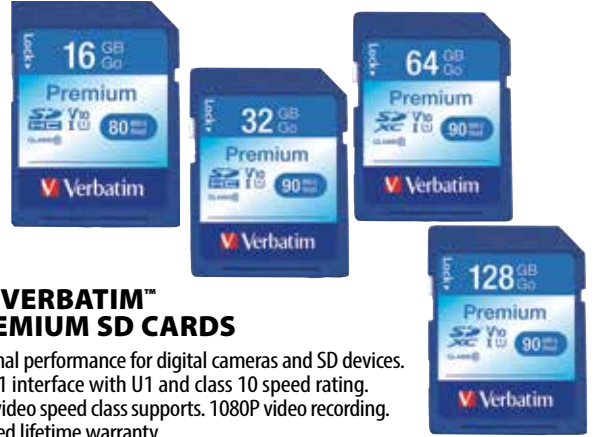

B VERBATIM™ PREMIUM SD CARDS

Optimal performance for digital cameras and SD devices. UHS-1 interface with U1 and class 10 speed rating. V10 video speed class supports. 1080P video recording. Limited lifetime warranty.

ORDER NUMBER	DESCRIPTION	UNIT
1 96808	16 GB, SDHC	EA
2 96871	32 GB, SDHC	EA
3 44024	64 GB, SDXC	EA
4 44025	128 GB, SDXC	EA



C EMTEC™ MICRO SDHC GOLD MEMORY CARDS

Ideal to increase the storage capacity of smartphones and tablets. Compatible with all devices supporting microSDHC and microSDXC standards. 45 MB/sec read, 14 MB/sec write speed. Class 10.

ORDER NUMBER	DESCRIPTION	UNIT
1 ECMSDM16GHC10GP	16 GB	EA
2 ECMSDM32GHC10GP	32 GB	EA
3 ECMSDM64GXC10GP	64 GB	EA



D KINGSTON® CANVAS SELECT™ MICRO SD CARD WITH ADAPTER

Designed to be reliable, making it ideal for filming in HD and shooting high-resolution photos on your Android™ smartphone. Class 10 UHS-I speeds up to 80MB/s read.

ORDER NUMBER	DESCRIPTION	UNIT
1 SDCS2/32GB	32 GB	EA
2 SDCS2/64GB	64 GB	EA
3 SDCS2/128GB	128 GB	EA
4 SDCS2/256GB	256 GB	EA



NEW!

E STARTECH EXTERNAL FLASH MULTI MEDIA MEMORY CARD READER

Offers quick access to the most popular flash card formats, from any computer with a USB port (optimal performance with 3.0, backward compatible with USB 2.0). Supports the most popular card types including SD, SDHC, SDXC, and MMC.

ORDER NUMBER	DESCRIPTION	UNIT
FCREADMICRO3	USB 3.0 card reader	EA



F VERBATIM™ POCKET CARD READER

A modern compact design makes transferring your digital photos fast and easy. Features an integrated USB 2.0 cable for plug-and-play functionality. Compatible with SD, SDHC, SDXC and MMC interfaces. Works with both Windows and Mac operating systems. Graphite.

ORDER NUMBER	DESCRIPTION	UNIT
97709	USB 2.0 card reader	EA



A VERBATIM™ CD-R 52X.

ORDER NUMBER	DESCRIPTION	UNIT
1 94935	Pack	10/PK
2 94691	Spindle	50/PK
3 94554	Spindle	100/PK



B VERBATIM™ DVD SPINDLES 16X.

ORDER NUMBER	DESCRIPTION	UNIT
1 95102	DVD-R	100/PK
2 95098	DVD+R	100/PK



C AVERY® CD LABELS

White permanent labels. Laser/inkjet.

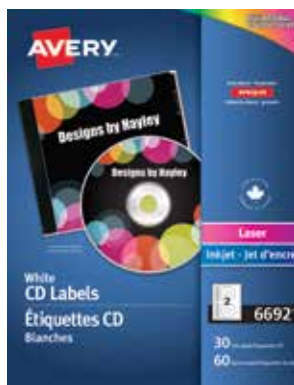

ORDER NUMBER	UNIT
67933-07692	40/EV



D VERBATIM™ EXTERNAL ALL-IN-ONE OPTICAL WRITER

Ideal solution for accessing or storing data on CDs, DVDs and Blu-ray discs. Compatible with all common disc formats, including high-capacity BDXL discs. Compact and lightweight, M Disc ready, includes USB Type-C® adapter. Compatible with Windows and Mac OS. 6X Blu-ray write speed, 8X DVD write speed; 24X CD write speed. 1-year limited warranty. Silver.



ORDER NUMBER	UNIT
71094	EA

E DAC® POLY SLIMLINE JEWEL CASES

Break resistant frosted poly cases hold one CD or DVD. Slimline design allows more storage in less space. Secure snap closure; inside tabs for liner notes.



ORDER NUMBER	UNIT
61754-02154	50/PK

F MAXELL® CD/DVD SLEEVES

Insert window allows easy viewing and organizing of the enclosed media. With protective flap.



ORDER NUMBER	DESCRIPTION	UNIT
1 190135	White	50/PK
2 190133	White	100/PK



G GEMEX® COMPACT DISK PAGE HOLDERS

Anti-static material to prevent scratches and loss of data. 11"×8½". Each page holds 4 CDs. Includes indexes.



ORDER NUMBER	UNIT
4CD-5	5/PK

H GREENSIDE MEDIA POCKET WITH FLAP

Self adhesive pockets with resealable flap to securely hold CDs or DVDs. Can be placed onto almost any surface. Ideal for binders or folders.



ORDER NUMBER	UNIT
20171G	10/PK

Data Storage – external hard drives



NEW!

A TOSHIBA CANVIO® ADVANCE PORTABLE HARD DRIVES

Secured in style. Take life anywhere. USB 3.2 Gen 1 (USB 2.0 compatible). Transfer rates up to 5.0 Gbit/s. Compatible with Windows®/Mac (reformatting required). Includes USB 3.2 Gen 1 Cable (Type A to Micro-B), backup software package and easy-to-configure security software. 2-year standard limited warranty. Black.

ORDER NUMBER	DESCRIPTION	UNIT
1 HDTCA10XK3AA	1 TB	EA
2 HDTCA20XK3AA	2 TB	EA
3 HDTCA40XK3CA	4 TB	EA



NEW!

B TOSHIBA CANVIO® FLEX PORTABLE HARD DRIVES

Combining compatibility and portability, the Canvio Flex is the cross-device storage solution built for your digital lifestyle. USB 3.2 Gen 1 (USB 2.0 compatible). Transfer rates up to 5.0 Gbit/s. Compatible with Mac/Windows® PC/Tablet. Includes USB-C® and USB-A cables. 3-year warranty. Silver.

ORDER NUMBER	DESCRIPTION	UNIT
1 HDTX110XSCAA	1 TB	EA
2 HDTX120XSCAA	2 TB	EA
3 HDTX140XSCCA	4 TB	EA



NEW!

C TOSHIBA CANVIO® READY PORTABLE HARD DRIVES

USB 3.2 Gen 1 (USB 2.0 compatible). Transfer rates up to 5.0 Gbit/s. Compatible with Windows®/Mac (reformatting required). USB 3.2 Gen 1 (Type-A to Micro-B) cable. 1 year standard limited warranty. Black.

ORDER NUMBER	DESCRIPTION	UNIT
1 HDTP310XK3AA	1 TB	EA
2 HDTP320XK3AA	2 TB	EA
3 HDTP340XK3CA	4 TB	EA



D WESTERN DIGITAL MY PASSPORT USB PORTABLE EXTERNAL HARD DRIVE

Slim, portable design makes it easy to bring on-the-go, and security features like password protection, hardware encryption, and drive management help ensure data stays safe and secure. 5000 MB/sec transfer rate. USB 3.0. Windows® 10 or Windows 8.1 operating systems. Requires reformatting for other operating systems. 4 1/4" x 2 9/16" x 3/16". 3-year limited warranty.

ORDER NUMBER	DESCRIPTION	UNIT
WDBYVG0010BBK-WESN	1 TB	EA



E VERBATIM™ VX500 SSD EXTERNAL USB 3.1 GEN 2 SOLID STATE DRIVE

Shock-resistant, sleek metal housing. Ultra-slim ideal for travel. Transfer rates up to 500MB/s. Backwards compatible with USB 2.0 ports. Windows operating systems only. Includes USB-A and USB-C cables and Nero backup software. 2-year limited warranty.

ORDER NUMBER	DESCRIPTION	UNIT
1 47441	120 GB	EA
2 47442	240 GB	EA
3 47443	480 GB	EA



NEW!

F EMTEC™ X210 ELITE PORTABLE 3.2 SOLID STATE DRIVE

Provides high speed transfer rates and a nomadic storage solution. Shock and vibration resistant. Compatible with Mac, Windows, Smart TVs and the latest gaming consoles.

ORDER NUMBER	DESCRIPTION	UNIT
1 ECSSD256GX210	256 GB	EA
2 ECSSD512GX210	512 GB	EA
3 ECSSD1TX210	1 TB	EA



A KENSINGTON® PRO FIT® ERGO VERTICAL WIRELESS TRACKBALL MOUSE

Natural handshake position to improve wrist and forearm alignment. High-quality optical tracking sensor, 34mm thumb-operated trackball and triple DPI switch provide smooth cursor control, optimal precision and easy cursor speed transitions. Flexible wireless connection options let you connect to up to 3 different devices. Works for up to 18 months on two AA batteries. Battery light indicator. Easy to use, with the same left click, right click, and scroll wheel operation as a traditional mouse. USB connectivity. Dimensions: 6.2"×4"×3.2".



ORDER NUMBER	UNIT
K75326WW	EA



C KENSINGTON® PRO FIT® VERTICAL WIRELESS MOUSE

Contoured, natural (46.7°) slope keeps the wrist in a neutral handshake position, eliminating soft tissue compression. An extended lip for the little finger provides complete support for smoother, larger muscle group movement. Fully-featured mouse has a scroll wheel, left, right, forward and back. Low battery indicator. One AA battery (included) lasts up to a year. USB connectivity. Dimensions: 4.42"×2.98"×2.81".



ORDER NUMBER	DESCRIPTION	UNIT
1 K75501WW	Black	EA
2 K75520WW	Grey	EA



NEW!

E VERBATIM® ERGO WIRELESS BLUE LED MOUSE

Say goodbye to noise and hello to silence. Silent click switches and rubber covers, this mouse is truly silent. Ergonomic design with thumb support lets you work all day with ease. Scroll wheel with adjustable DPI button lets you switch between 800, 1300 and 1600 DPR while back and forward buttons allow you to easily navigate between pages in your browsers. Blue LED technology allows you to point and click on more surfaces from glass tables to granite countertops. Connect with USB receiver. 2.4 GHz wireless technology. 1-year limited warranty. Uses 1 "AA" battery (included). Dimensions: 3.95"×2.95"×1.58".

ORDER NUMBER	DESCRIPTION	UNIT
1 70243	Red	EA
2 70242	Graphite	EA
3 70244	Dark Teal	EA



B LOGITECH® ERGO M575 WIRELESS TRACKBALL MOUSE

Forget about sliding around a mouse or moving your arm to move the cursor. The Ergonomic sculpted shape of the M575 minimized movement and maximizes comfort while keeping your hand and arm relaxed. Scroll wheel with large, easy-to-reach Back/Forward buttons. Connect with Bluetooth® or USB receiver up to 33 ft range. 2.4 GHz wireless technology. Large. Uses 1 "AA" battery (included). Up to 24 months on battery, 20 months with Bluetooth®. Black.



ORDER NUMBER	UNIT
910-005869	EA



D ADESSO IMOUSE VERTICAL ERGONOMIC MOUSE

Designed with a vertical orientation and a contoured shape to provide a uniquely comfortable user experience. Wrist-friendly contour support holds your hand in a healthy "handshake position" which is the neutral position of your forearm. Featuring two ergonomic buttons that are located conveniently on the side of the mouse allowing seamless back and forth browsing. 6 Buttons (left & right click, back & forward, DPI switch and scroll wheel). USB connectivity. Dimensions: 3"×4.7"×2.5".



ORDER NUMBER	DESCRIPTION	UNIT
IMOUSE E10	For Right-handed users	EA



NEW!

F LOGITECH® M650 SIGNATURE BUSINESS WIRELESS MOUSE

Upgrade to smarter scrolling, better comfort and more productivity. Logi Bolt receiver, engineered to meet rising security expectations, combined with Bluetooth® Low Energy wireless technology. Silent clicks and customizable side buttons. SmartWheel scrolling delivers precision and speed. Bluetooth® and USB connectivity. 2.4GHz wireless connection with 10 metres of wireless range. 1 "AA" battery (included) Up to 20 months of battery life. 2-year limited warranty. Graphite.



ORDER NUMBER	DESCRIPTION	UNIT
1 910-006272	4.25"×2.43"×1.49"	EA
2 910-006346	4.65"×2.58"×1.64"	EA



NEW!

G LOGITECH® M720 TRIATHLON MULTI-DEVICE WIRELESS MOUSE

Seamlessly switch between 3 devices. Logitech Advanced Optical Tracking and boosted efficiency - 24 months of power on a single AA battery. 3G Core scroll wheel with 8 buttons. Tilt wheel with middle click. Bluetooth® Smart connection. 2.4 GHz wireless connection with 10 m of wireless range. 1 "AA" battery (included). 1-year limited warranty. Black. 4.53"×2.91"×1.77".



ORDER NUMBER	UNIT
910-004790	EA

Computer Accessories – mice



A LOGITECH® M510 WIRELESS LASER MOUSE

Contoured with soft side grips. 5 buttons including scroll wheel. Laser tracking on almost any surface. Back/Forward programmable control buttons. Uses 2 "AA" batteries with up to 2-year battery life. Unifying receiver stays in your laptop. Dimensions: 4.72"×2.56"×1.61".



ORDER NUMBER	UNIT
910-001822	EA



B LOGITECH® WIRELESS MOUSE M310

The easy-to-use mouse that feels just right. Left-handed or right, you'll be comfortable with this contoured design with soft rubber side grips. The wireless, USB nano-receiver is always ready for use. Plug it in once and forget about it. With 12 months of battery life, you don't have to deal with the hassle of frequent battery changes. Dimensions: 4.4"×2.4"×1.5".



ORDER NUMBER	UNIT
910-001675	EA



NEW!

C KENSINGTON® WIRELESS MOUSE FOR LIFE

Comfortable contoured shape for either right or left-handed users. High-definition optical sensor and USB nano receiver with Plug & Play installation. Three-button scroll wheel. 2.4 GHz wireless technology. Uses 1 "AA" battery (included). 5-year limited warranty. Dimensions: 5.25"×2.25".



ORDER NUMBER	UNIT
K72392WWA	EA



NEW!

D LOGITECH® M185 WIRELESS LASER MOUSE

Comfortable and easy-to-use for left or right handed users. Contoured shape that follows the natural curve of your hand. Controlled line-by-line scrolling for easier navigation. USB wireless connectivity with up to 10-metre range. Uses 1 "AA" batteries (included). 3-year limited warranty. Black. Dimensions: 3.9"×2.36"×1.54".



ORDER NUMBER	UNIT
910-002225	EA



E VERBATIM™ USB-C™ WIRELESS BLUE LED MOUSE

Adjustable DPI button, lag-free performance, side back/forward buttons, use on virtually any surface. Ergo-friendly shape & easy grip. USB connectivity. 2.4 GHz wireless technology. Uses 1 "AA" battery (included). Dimensions: 4.02"×2.62"×1.52".



ORDER NUMBER	DESCRIPTION	UNIT
1 70246	Red	EA
2 70245	Graphite	EA
3 70247	Teal	EA



F VERBATIM™ WIRELESS NOTEBOOK 6-BUTTON DELUXE BLUE LED MOUSE

Features Blue LED technology - navigate with precision and control on virtually any surface. Buttons include: standard left/right click, scroll wheel, back/forward buttons to easily navigate between browser pages, and Windows 8 home button. Connects to computer via nano receiver, small enough to plug in and leave connected. 2.4 GHz wireless technology. Dimensions: 4.20"×2.95"×1.46".

ORDER NUMBER	DESCRIPTION	UNIT
1 99016	Blue	EA
2 99018	Red	EA
3 99017	Purple	EA
4 98621	Graphite	EA



G KENSINGTON® PRO FIT® BLUETOOTH® COMPACT MOUSE

Connect without using a valuable USB port. Three-button scroll wheel design, quiet clicking, pairing and low battery indicator. Ambidextrous design. Bluetooth connectivity. Supports Bluetooth 3.0 and 5.0. Uses 1 "AA" battery (included). 3-year warranty. Dimensions: 3.8"×2.3"×1.28".

ORDER NUMBER	UNIT
K74000WW	EA



NEW!



A VERBATIM™ WIRELESS NOTEBOOK MULTI-TRAC BLUE LED MOUSE

Comfort grip shape. Blue LED technology allows users to point and click on more surfaces than any other mouse. Nano receiver can be stored in battery compartment. Dimensions: 2.45"×3.89"×1.52".

ORDER NUMBER	DESCRIPTION	UNIT
1 97992	Black	EA
2 97993	Blue	EA
3 97995	Red	EA
4 97994	Purple	EA



B KENSINGTON® PRO FIT™ WIRELESS MID-SIZE MICE

Compact for travel convenience. Wireless. Storable nano receiver. Ergonomic right-handed design. High definition optical sensor (1750 DPI) for responsive control. Dimensions: 3.9"×2.6"×2".

ORDER NUMBER	DESCRIPTION	UNIT
1 K72405USA	Black	EA
2 K72421AMA	NEW! Sapphire	EA
3 K72422AMA	Ruby red	EA
4 K72423AMA	Grey	EA



C VERBATIM™ BLUETOOTH® WIRELESS TABLET MULTI-TRAC BLUE LED OPTICAL MOUSE

Experience wireless freedom; requires no receiver to connect wirelessly to Android or Windows Bluetooth enabled tablet or Windows/Mac computer. Blue LED technology allows users to navigate on virtually any surface with precision and control. 1600 DPI, low power consumption, contoured shape, ambidextrous design and scroll wheel. Requires 1 "AAA" battery (included). Dimensions: 3.35"×2.2"×1.3".

ORDER NUMBER	DESCRIPTION	UNIT
1 98590	Graphite	EA
2 70239	Dark Teal	EA
3 70240	Garnet	EA



D LOGITECH® M325 WIRELESS MOUSE

A wireless mouse that delivers a better mix of precision and comfort. Micro-precise scrolling. A comfy, contoured shape. Plug Logitech™ unifying receiver into notebook and leave it there. Dimensions: 3.73"×2.24"×1.54".

ORDER NUMBER	DESCRIPTION	UNIT
1 910-002974	Black	EA
2 910-002650	New blue	EA
3 910-002651	NEW! Red	EA

E KENSINGTON® SURETRACK™ DUAL WIRELESS MOUSE

First lightweight mouse to offer adaptable wireless connectivity options (2.4GHz, Bluetooth 3.0 and Bluetooth 5.0) to accommodate a wide range of computing devices from laptops and desktop PCs to mobile smart devices. Precision tracking on the most difficult surfaces, including glass. AES 128-bit encryption, a triple DPI switch for simple cursor speed transitions, premium quiet buttons. Ambidextrous 3-button design. 2.4 GHz wireless technology, Bluetooth® 3.0 or 5.0. Requires 2 "AAA" batteries (included). Dimensions: 4.3"×2.4"×1.4".

ORDER NUMBER	DESCRIPTION	UNIT
1 K75298WW	Black	EA
2 K75350WW	Blue	EA
3 K75352WW	Red	EA
4 K75353WW	White	EA
5 K75351WW	Grey	EA



Computer Accessories – mice



A VERBATIM™ SILENT WIRELESS BLUE LED MOUSE

Using new Silent Technology, silent click switches, and rubber covers, this Verbatim mouse is truly silent. Blue LED technology allows users to point and click on more surfaces than other mice – from a glass table to the granite kitchen counter. Comfort-grip shape. USB connectivity. 2.4 GHz wireless technology. Medium. Uses 2 “AAA” batteries (included). 3.74”x2.28”

ORDER NUMBER	DESCRIPTION	UNIT
1 99769	Graphite	EA
2 99770	Blue	EA



B VERBATIM™ COMMUTER SERIES WIRELESS OPTICAL MOUSE

Sleek design offers a smooth, contoured comfort grip for right or left hand users. Small enough to fit easily into bags and totes. Nano receiver can be plugged in and left. Scroll wheel. 1 “AA” battery (included). 4”x2.24”.

ORDER NUMBER	DESCRIPTION	UNIT
1 99765	Matte Black	EA
2 99766	Matte Blue	EA
3 99767	Matte Red	EA
4 99768	Matte White	EA
5 99781	Matte Purple NEW!	EA



C MICROSOFT® WIRELESS MOBILE MOUSE 1850

Designed for comfort and portability. Ambidextrous. Built-in mini transceiver. Scroll wheel. 2.5 GHz wireless technology. Uses 1 “AA” battery (included). Dimensions: 3.95”x2.29”.

ORDER NUMBER	UNIT
U7Z-00002	EA



D LOGITECH® B100 OPTICAL MOUSE

It works right out of the box. This plug-and-play mouse is simple to set up. Comfortable for either left or right-handed users. USB connectivity. Accurate, line-by-line scrolling makes your everyday tasks smooth and easy. Medium. 3-year limited warranty. Black. Dimensions: 4.45”x2.44”x1.5”.

ORDER NUMBER	UNIT
910-001439	EA



E VERBATIM® CORDED OPTICAL MOUSE

Ergonomic design with sleek, glossy finish. High resolution optical technology for smooth and precise tracking. Precision scroll wheel for easy scrolling. 1-year limited warranty. Dimensions: 3.9”x2.4”x1.37”.

ORDER NUMBER	DESCRIPTION	UNIT
1 98106	Black	EA
2 99743	Blue	EA
3 99742	Red	EA
4 99740	White	EA
5 99741	Silver	EA



F VERBATIM® SILENT CORDED OPTICAL MOUSE

Say goodbye to noise and hello to silence. Truly silent mouse featuring Silent Technology, silent click switches, and rubber covers. High-resolution optical technology, ergonomic design and comfort grip. Precision scroll wheel for easy scrolling. 1-year limited warranty. Dimensions: 4.61”x2.46”x1.52”.

ORDER NUMBER	DESCRIPTION	UNIT
1 99790	Black	EA
2 70233	Blue	EA
3 70234	Red	EA
4 70235	Purple	EA



G LOGITECH® WIRED MOUSE M100

Fast and easy setup – just plug the cable into a USB port. Full-size, ambidextrous design; precise optical tracking. Dimensions: 4.45”x2.44”x1.5”.

ORDER NUMBER	UNIT
910-001601	EA



H KENSINGTON® PRO FIT™ WIRED MID SIZE MOUSE

Mid-sized, right-handed design for lasting comfort; made to withstand drops and spills. USB connection; 6’ cord. Windows 7, Vista and XP compatible. Dimensions: 3.9”x2.6”x1.5”.

ORDER NUMBER	UNIT
K72355US	EA



I KENSINGTON® MOUSE FOR LIFE

Silent click reduces noise. Reliable plug-and-play operation with wired USB connection. Comfortable contoured shape in an ambidextrous design. High definition optical sensor for responsive control. Scroll wheel. Limited lifetime warranty. Black. Dimensions: 4”x2.88”x1.5”.

ORDER NUMBER	UNIT
K72110WW	EA

Computer Accessories – mouse pads and wrist rests



A FELLOWES® RECYCLED OPTICAL MOUSE PAD

Durable, earth-friendly, easy-to-clean surface. Contains a minimum of 95% post-consumer recycled material. Non-skid rubber base. Ultra thin and lightweight. 9"W×7½"D×¼"H.

ORDER NUMBER	DESCRIPTION	UNIT
1 5916201	Mountain Sunrise	EA
2 5903901	Ocean	EA
3 5916901	Puppy and Kitten	EA

B 3M™ PRECISE™ REPOSITIONABLE MOUSE PAD

Precise™ surface enhances the precision of optical mice at fast speeds. Battery saving design extends the battery life of wireless mice up to 50%. Ultra-thin pad with repositionable adhesive can be conveniently stored on the back of your computer. 8½"W×7"D. Silver.

ORDER NUMBER	UNIT
MP200PS	EA



C 3M™ PRECISE™ MOUSE PAD WITH GEL WRIST REST

Battery saving design enhances the precision of optical mice at fast speeds and also extends the life of wireless mice by up to 50%. Soothing gel is firm enough to provide the support you need but soft enough for optimal comfort.

ORDER NUMBER	DESCRIPTION	UNIT
1 MW309LE	6 7/8"W×8 5/8"D NEW!	EA
2 MW310LE	9 1/2"W×8 3/4"D	EA
3 MW85B	8 1/2"W×9"D Square	EA



D DAC® MOUSE PAD

Anti-static with a high friction surface and non-slip backing. Non-skid sponge covered with nylon cloth. 8¼"W×10¼"D.

ORDER NUMBER	DESCRIPTION	UNIT
1 61754-02108	Black	EA
2 61754-02109	Blue	EA



E FELLOWES® MOUSE PADS

Skid-free natural rubber offers the perfect mousing surface for enhanced accuracy. Built-in Microban® bacteria protection; long-lasting polyester surface stands up against everyday wear and tear; superior tracking with both ball & optical mice, all while protecting your desk surface. 9"W×8"H×0.13"D

ORDER NUMBER	DESCRIPTION	UNIT
1 5933801	Navy	EA
2 5933901	Black	EA



F CEP SILVA MOUSEPAD

Offers stylish, refined design for a soft and elegant environment. Anti-glare transparent cover to keep a photo or other useful notes in view. Compatible with all types of computer mouse. Base made of anti-slip soft foam. Washable on both sides. Phthalate-free PVC. 8 1/3"W×5 9/10"D×1/12"H. White/Beech.

ORDER NUMBER	UNIT
CEP810	EA



A FELLOWES® PROFESSIONAL SERIES WRIST SUPPORT & MOUSE PAD WITH MICROBAN®

Patented Health-V Channel relieves wrist pressure to prevent carpal tunnel syndrome. Optical laser friendly pad improves mouse performance. Features Microban antimicrobial protection. Gel. 8¼"W×9⅞"D.

ORDER NUMBER	UNIT
9182301	EA



B LOEXPONENT® ERGO GEL MOUSE PAD

Ergonomic design mouse pad with built-in wrist rest. 7¾"W×9⅛"H×⅝"D.

ORDER NUMBER	DESCRIPTION	UNIT
1 56404	Blue	EA
2 56406	Black	EA



C KENSINGTON® MOUSE WRIST PILLOW™

Distributes wrist pressure more evenly for ultimate comfort while mousing. For use with any mouse or trackball. 9"W×12"D.

ORDER NUMBER	DESCRIPTION	UNIT
1 L57822US	Black	EA
2 L57803USF	Blue NEW!	EA



D KENSINGTON® ERGO SOFT™ WRIST REST MOUSE PAD

Professional performance-focused design combines functional, sophisticated low-profile with a preferred, hard mouse surface, non-skid back, and easy-to-clean surface. Ultra-soft exterior is supported by gel cushioning and unique texture optimising mouse performance. High-performance mouse pad surface provides best-in-class tracking control for both optical and laser mice. 7⅝"W×9½"D.

ORDER NUMBER	DESCRIPTION	UNIT
1 K55888WW	Black	EA
2 K50437WW	Grey NEW!	EA



NEW!



E KENSINGTON® WRIST PILLOW™

Super-soft cushion cradles your wrists for more comfortable typing.

ORDER NUMBER	DESCRIPTION	UNIT
L22801US	19¼"W×3½"D×1"H	EA

F KENSINGTON® ERGO SOFT™ WRIST REST

Scientifically developed to prevent injury while optimizing comfort. Low profile makes it ideal for slim keyboards. Ultra-soft with premium exterior that is supported by gel-cushioned padding. Optimal health comfort and protection through proper alignment, tailored dimensions and unique curved design. Slim. Black.

ORDER NUMBER	DESCRIPTION	UNIT
K52800WW	17"W×3½"D×½"H	EA

Computer Accessories – mouse pads and wrist rests



A FELLOWES® HEIGHT ADJUSTABLE GEL DESK ACCESSORIES

Relieves wrist pressure to help prevent carpal tunnel syndrome. Height and angle adjustable. Features 2 flat positions with a 10 mm forward or negative tilt adjustment. Polyester fabric covering soothing gel. Graphite.

ORDER NUMBER	DESCRIPTION	UNIT
1 9374201	Wrist Rest 19¼"W×3½"D×1"H	EA
2 9374001	Optical Mouse Pad 6⅓"W×9⅔"D×1"H	EA



B DAC® SUPER- GEL WRIST REST/ MOUSE PAD

Gel filled platform provides comfortable support while mousing. Soft Lycra® fabric cover. Blue.

ORDER NUMBER	DESCRIPTION	UNIT
1 61754-02122	Contoured Wrist Rest 18"W×3"D×¾"H	EA
2 61754-02124	Straight Wrist Rest 18"W×2¼"D×¾"H	EA
3 61754-02123	Mini Round Mouse Pad 8"W×9⅓"D	EA
4 61754-02121	Mouse Pad 8"W×9¾"D	EA



C FELLOWES® PLUSHTOUCH™ WRIST REST WITH MICROBAN®

The Softest Place Your Wrists Can Rest™. Innovative FoamFusion™ Technology provides superior comfort to help relieve wrist pressure. Microban® antimicrobial protection keeps product cleaner. Non-skid backing keeps pad in place. Soft breathable material withstands daily wear and tear. Black.

ORDER NUMBER	DESCRIPTION	UNIT
1 9252002	Mouse Pad 7¼"W×9½"D×1"H	EA
2 9252102	Wrist Rest 18½"W×3½"D×1"H	EA
3 9355801	Mini Wrist Rest 4⅞"W×3⅝"D×1"H	EA

NEW!



E 3M™ GEL WRIST REST FOR STANDING DESKS

Wider and deeper than traditional wrist rests to accommodate different working positions between sitting and standing. Wraparound design is easy to place on your desk making it feel like part of your desk. 3M gel technology is firm enough to provide the support you need, but soft enough for optimal comfort. Covered in a leatherette material. Black.

ORDER NUMBER	DESCRIPTION	UNIT
WR200B	30¾"W×1"D×3¼"H	EA



D FELLOWES® ULTRATHIN PLUSHTOUCH™ MOUSE PAD

The Softest Place Your Wrists Can Rest™. Innovative FoamFusion™ Technology provides superior comfort to help relieve wrist pressure. Optical / Laser - friendly mouse pad improves mouse performance. Non-skid backing keeps mouse pad in place. Soft breathable material withstands daily wear and tear. Black.

ORDER NUMBER	DESCRIPTION	UNIT
1 9297401	Mouse Pad 7⅞"W×9½"D×⅔"H	EA
2 9297501	Wrist Rest 18¾"W×2½"D×⅔"H	EA



F 3M™ GEL WRIST REST WITH ANTIMICROBIAL PROTECTION

Features a cushioning gel that conforms to the natural contours of your wrists. Non-irritating and non-chafing. Black leatherette.

ORDER NUMBER	DESCRIPTION	UNIT
WR310LE	19"W×2.8"D×0.75"H	EA

Check online for the most current price.

Computer Accessories – keyboards

**A KENSINGTON® SPILL-SAFE WIRED KEYBOARD**

Black 104-key keyboard that resists accidental spills. Sealed membrane design lets liquids run through without damaging keyboard electronics. Slim profile saves valuable workspace; sturdy metal back plate provides added strength. Sleek design; USB connectivity.

ORDER NUMBER	UNIT
K64370A	EA

**C KENSINGTON® PRO FIT® USB WASHABLE KEYBOARD**

A thin membrane protects the internal components and allows you to fully immerse keyboard in water to clean it from food, soda, coffee or any other unwanted substances. Safely stands up to immersion or frequent use of spray cleaners (USB connector cannot get wet.). Full-size 104-key layout. Provides direct and reliable connection for continuous performance and eliminates the need for batteries. Compatible with Windows 10, 8.1, 8, 7 and Mac OS X 10.6 and later. With 6 rows of keys including a numeric keypad, the layout is ideal for the touch typist looking for comfort and responsiveness. Provides direct and reliable connection for continuous performance and eliminates the need for batteries. Wired, reliable USB connectivity. English. Black.

ORDER NUMBER	UNIT
K74200CA	EA

**E VERBATIM™ WIRELESS SLIM KEYBOARD**

Space-saving, slim design. Quiet, soft-touch keys. Plug-and-forget nano receiver. Full-size keyboard with numeric keypad. 2.4 GHz wireless connection. English.

ORDER NUMBER	UNIT
99793	EA

**B VERBATIM™ SLIMLINE WIRED KEYBOARD**

Sleek, sturdy, slim. Efficient design frees up space on your desktop. Full size function keys and number pad. Low profile keys and adjustable tilt legs for quiet, comfortable typing. Compatible with both Windows & Mac OS. USB connectivity.

ORDER NUMBER	UNIT
99201	EA

**D SEAL SHIELD® SILVER STORM™ MEDICAL GRADE USB KEYBOARD**

Dishwasher safe and Antimicrobial product protection. IP-66 washable, True Type, Full Travel keys, 24k Gold USB. USB connection. English.

ORDER NUMBER	UNIT
STK503	EA

**F LOGITECH® K120 KEYBOARD**

USB keyboard provides a better typing experience and is built to last. Low-profile, whisper-quiet keys and standard layout with full-size F-keys and number pad. Spill-resistant design, sturdy tilt legs and durable keys. Simply plug it into any USB port on your desktop, laptop or netbook and start using!

ORDER NUMBER	UNIT
920-002478	EA



NEW!

A TARGUS® MULTI-DEVICE BLUETOOTH® ANTIMICROBIAL KEYBOARD

Slimline design effortlessly slips into the side of your briefcase or backpack. DefenseGuard™ Antimicrobial Protection* creates a cleaner surface and works continuously to protect the keyboard by preventing the growth of microorganisms for the life of the product. Multi-device connectivity for up to 3 devices. Bluetooth® 5.1 wireless technology. 2 x AAA batteries included. Compatible with Windows® and macOS®.

ORDER NUMBER	DESCRIPTION	UNIT
1 AKB863US	Midsized - with numeric keypad	EA
2 AKB862US	Compact - without numeric keypad	EA



B LOGITECH® K400 PLUS WIRELESS TOUCH KEYBOARD

Designed for laid-back control. Integrated keyboard with touchpad. Plug-and-play setup. Hot keys and shortcuts for Windows® and Android™ users. 10 m wireless range. Media-friendly TV keyboard with easy-access volume controls and arrow keys. 18-month battery life. Designed for use with Windows® 7, 8 10 and later. Android™ 5.0 or later and Chrome OS™. Wireless USB 2.4 GHz. 14"W×1"D×5½"H.

ORDER NUMBER	UNIT
920-007119	EA



C KENSINGTON® MULTI-DEVICE DUAL WIRELESS COMPACT KEYBOARD

Connect and switch between up to three devices at a time (computer, tablet, or phone). Windows, macOS, iOS, and Chrome OS compatible. Compact design. Smooth, responsive scissor keys include multimedia hot keys. Low battery indicator. Dual wireless using Bluetooth® (3.0 or 5.0) or 2.4GHz wireless with 128-bit AES encryption security. Three-year warranty. English. 2"AAA" batteries included.

ORDER NUMBER	DESCRIPTION	UNIT
1 K75502US	Black	EA
2 K75504US	Silver	EA



NEW!

D LOGITECH® MX KEYS ADVANCED WIRELESS KEYBOARD

Advanced wireless illuminated keyboard crafted for efficiency, stability and precision. Perfect stroke keys are shaped for your fingertips and increase key stability reducing noise while optimizing responsiveness. Tactile reference for hand positioning makes it easy to stay oriented and in your flow. Backlit keys light up the moment your hands approach and automatically adjust to suit changing light conditions. Multi-device lets you pair up to 3 devices. Switch between devices with the tap of a button. USB wireless or Bluetooth® technology. English.

ORDER NUMBER	UNIT
920-009295	EA



E LOGITECH® ERGO K860 SPLIT WIRELESS KEYBOARD

Designed for better posture, less strain and more support. You'll type more naturally with a curved, split keyframe. The sloping form reduces muscle strain on your wrists and forearms. Bluetooth® 5.0, USB wireless. English.

ORDER NUMBER	UNIT
920-009166	EA



F KENSINGTON® PRO FIT WIRELESS KEYBOARD

Spill-proof protection. Mini-sized dongle receiver. Full-size keyboard with numeric keypad. 2.4 GHz wireless connection. English.

ORDER NUMBER	UNIT
K72450USA	EA



A TARGUS WIRELESS NUMERIC KEYPAD

Full sized, comfortable keys for increased accuracy. Great for working on spreadsheets, accounting files or financial applications. Wireless technology provides a cordless workspace and keypad functions up to 33 ft from the receiver. Ergonomic tilt provides support to help prevent wrist strain. Battery indicator light shows when batteries are low. 1-year limited warranty. Black.



ORDER NUMBER	UNIT
AKP11US	EA



NEW!



C VERBATIM™ SILENT WIRELESS COMPACT KEYBOARD AND MOUSE

Say goodbye to noise and hello to silence with silent key design and silent click switches. Plug-and-forget nano receiver connects mouse and keyboard to computer. Hot keys to provide instant access to media controls. Silent mouse features Multi-Trac Blue LED technology, allowing user to point and click on more surfaces. Ergonomically designed for comfort grip and ease of use. 2.4GHz wireless technology. Uses 2 "AAA" batteries (included). 1-year limited warranty. Black.

ORDER NUMBER	UNIT
70739	EA



E MICROSOFT® WIRELESS 3050 KEYBOARD/BLUETRACK™ MOUSE COMBO

Mouse has BlueTrack™ technology which allows for better tracking and accuracy on most surfaces. Built in palm rest and customizable shortcut keys. 2.4 GHz wireless technology. 5 buttons including scroll wheel button. Ambidextrous mouse.

ORDER NUMBER	UNIT
PP3-00002	EA



NEW!

B LOGITECH® MK235 WIRELESS KEYBOARD AND MOUSE COMBO

Features long life UV-coated, abrasion-resistant keys, spill-resistant up to 60 ml and 128-bit AES keyboard encryption. Advanced optical tracking for smooth, responsive cursor control, and ambidextrous mouse design. Up to three years battery life for the keyboard and up to a year for the mouse. Included: 2 AAA batteries for keyboard, 1 AA battery for mouse.

ORDER NUMBER	UNIT
920-007897	EA



NEW!

D LOGITECH® MK270 WIRELESS KEYBOARD AND MOUSE COMBO

Features advanced 2.4 GHz wireless connectivity, 128-bit AES keyboard encryption, 24-month keyboard and 12-month mouse battery life, auto-sleep and on/off switches, eight hot keys for instant access to the Internet, e-mail, play/pause, volume and more. Low-profile design and whisper-quiet keys. Certified carbon neutral. Included: 2 AAA batteries for keyboard, 1 AA battery for mouse.

ORDER NUMBER	UNIT
920-004536	EA



NEW!

F LOGITECH® MK850 WIRELESS KEYBOARD AND MOUSE COMBO

Wireless keyboard and mouse with Bluetooth connectivity can work with multiple devices and are compatible with multiple operating systems. Contoured right-handed mouse. Mouse can be paired with up to 3 screens. Use the keyboard with your computer and then easily switch to typing on your phone, tablet, or a second computer. Compatibility with Windows 10, 11 or later, Linux, Chrome OS, macOS 10.15 or later, iPadOS 13.4 or later, Android 7 or later. Certified carbon neutral. Included: 2 AAA batteries for keyboard, 1 AA battery for mouse.

ORDER NUMBER	UNIT
920-008219	EA



A VERBATIM™ SLIMLINE CORDED USB KEYBOARD/MOUSE COMBO

Full size function keys and number pad. Low profile keys and adjustable tilt legs for quiet, comfortable typing. Included mouse provides smooth, precise tracking in a comfortable, contoured design for effortless navigation. USB connectivity. 1-year limited warranty.



ORDER NUMBER	UNIT
99202	EA



B VERBATIM™ WIRELESS KEYBOARD AND MOUSE COMBO

Plug-and-forget nano receiver, lag-free performance, hot keys, ambidextrous 1000 dpi mouse. Requires 1 "AAA" battery (keyboard), 1 "AA" battery (mouse) (included). 2.4GHz wireless technology. English. Black.



ORDER NUMBER	UNIT
70724	EA



C VERBATIM™ SILENT WIRELESS DESKTOP COMBO

Say goodbye to noise and hello to silence. Silent click switches and rubber covers. Plug-and-forget nano receiver connects mouse and keyboard to computer. Full numeric keypad and full-size function keys. Silent mouse features Blue LED technology, allowing user to point and click on more surfaces. Ergonomically designed for comfort grip and ease of use. 2.4GHz wireless technology. English.



ORDER NUMBER	UNIT
99779	EA



D LOGITECH® DESKTOP MK120

A durable duo that brings comfort, style and simplicity together. Your hands will enjoy the low-profile whisper quiet keys and standard layout with full size F-keys and number pad. It's tough with a spill-resistant design, sturdy tilt legs and durable keys. You'll be moving along smoothly with a precise, high definition optical mouse to help you get around.



ORDER NUMBER	UNIT
920-002565	EA



NEW!

E KENSINGTON® PRO FIT® WIRELESS COMFORT DESKTOP SET

Can be user configured in nine different positive, neutral and negative positions for a totally customized fit. Features ergonomic, right-handed wireless mid-size mouse, fully padded wrist rest, dedicated quick keys, spill-proof keyboard, and extended battery life. English.



ORDER NUMBER	UNIT
K72403USA	EA



F LOGITECH® MK320 WIRELESS DESKTOP COMBO

The combo that puts entertainment and portability at your fingertips - thanks to 11 hot keys and a go-anywhere mouse. Sleek, comfortable design.



ORDER NUMBER	UNIT
920-002836	EA

Computer Accessories – keyboards



A MICROSOFT® DESKTOP 2000 WIRELESS COMBO FOR BUSINESS

AES feature helps protect business information by encrypting what you type. Classically designed straight keyboard with pillow-textured palm and wrist support. Full-size mouse with 4-way scrolling and BlueTrack Technology.

ORDER NUMBER	UNIT
M7J-00002	EA



B LOGITECH® WAVE™ MK550 DESKTOP COMBO

Wave shaped keyboard supports the varied lengths of your fingers. Cushioned, contoured palm rest. Hand friendly laser mouse. Logitech® unifying receiver.

ORDER NUMBER	UNIT
920-002555	EA



C MICROSOFT® SCULPT COMFORT WIRELESS DESKTOP COMBO

Contoured design promotes a natural palm rest and adjustable keyboard legs. Split space bar with backspace functionality to improve typing efficiency. Mouse has four-way scrolling. The mouse has windows touch tab optimized for Windows 8. System requirements: Windows 8, Windows RT, Windows 7.

ORDER NUMBER	UNIT
L3V-00002	EA



D KENSINGTON® PRO FIT® ERGO WIRELESS KEYBOARD

Ergonomist-approved. Quiet, spill-proof keys. Split, sloped keyboard with adjustable reverse tilt positions hands, wrists, and forearms for comfort and neutral alignment. Built-in wrist rest. Dual wireless with 128-bit AES encryption security delivers the flexibility of 2.4 GHz and Bluetooth 4.0 LE, with government-grade encryption. USB connection.

ORDER NUMBER	DESCRIPTION	UNIT
1 K75401US	Keyboard only	EA
2 K75406US	Keyboard and 5 button mouse	EA

logitech FEATURE



E LOGITECH® MK540 ADVANCED WIRELESS DESKTOP COMBO

Familiar key shape and feel, whisper-quiet. Three-tilt position, spill-resistant. Contoured mouse with soft rubber grips. Full-size. Ambidextrous. Advanced optical tracking with 3 buttons and scroll wheel. Tiny Logitech® Unifying receiver is so small it stays in your PC or laptop. Uses 3 "AA" batteries. Up to 36 months of battery life for the keyboard and 18 months for the mouse.

ORDER NUMBER	UNIT
920-008671	EA

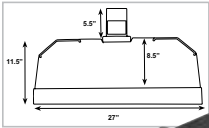

A HORIZON JITTERBUG ARTICULATING KEYBOARD PACKAGE

Height adjustment of 8½" (2½" above). Tilt adjusts +10° to -15°. Track length 21" with 360° swivel mount. Includes 27" Gelfoam™ palm/wrist support and cord management rails. 27"W×11½"D.

ORDER NUMBER	UNIT
JB-01	EA



B FELLOWES® DESIGNER SUITES™ COMPACT KEYBOARD TRAY

Fully adjustable tray enhances comfort in smaller workspace. Loosen single knob to adjust tray height and tilt. Warning Trak™ helps prevent mouse from sliding off platform. Soothing memory foam wrist supports with Microban™ protection stay cleaner. Non-skid pads prevent undesired keyboard movement. Compact 17 5/16" glide track to fit restricted workspaces. 27½"W×18"D×3"H. Black.

ORDER NUMBER	UNIT
8017801	EA



C EXPONENT® KEYBOARD TRAY

Ergonomic keyboard and mouse tray mounts under your desk. Deluxe rolling track for smooth in and out movement. Easily adjustable with knob. Tilts the tray angle up to 20 degree for a customizable height. 26½"W×10 5/8"D. Black.

ORDER NUMBER	UNIT
56319	EA



D HORIZON® SLIDE OUT KEYBOARD DRAWER

An economical solution to free up desktop real estate. Durable, 28" wide keyboard / mouse shelf features ball bearing slides, durable black melamine laminate surface, and enough space to store and use a keyboard and mouse on the same surface. 28"W×11¾"D.

ORDER NUMBER	DESCRIPTION	UNIT
1 KL-28S	Keyboard drawer	EA
2 KL-28S-G27	Keyboard drawer with gel foam wrist rest	EA



E KENSINGTON® UNDERDESK SUPERSHELF™ PLUS

Easy to install. 3 height adjustments for comfort. Extra-wide 26" with mousing area. Full length wrist pad. Fits all size keyboards. Cables exit through bottom of tray for better management. Size: 29"W×29½"D×2¼"H.

ORDER NUMBER	UNIT
K60004US	EA



F FELLOWES® UNDERDESK KEYBOARD MANAGER

The drawer adjusts the keyboard to 3 different heights. Retractable mouse tray installs on either the left or the right side. Size: 2.3"H×22"W×11.63"D.

ORDER NUMBER	UNIT
9140301	EA

Computer Accessories – keyboard trays



A OFFICES TO GO® ARTICULATING KEYBOARD COMBO

Low profile design. +1.0" to -5.0" height range. -15° to +15° tilt range. Track length 18" with 360° swivel mount. Includes removable palm/wrist support and mouse fence with cable manager for when the tray is tilted. 27"W×11"D. Black.

ORDER NUMBER	UNIT
MVLKP01	EA



C GLOBAL® ARTICULATING KEYBOARD TRAY

High-density polyethylene utility tray allows the keyboard and mouse to be positioned at the same height. Slim Fit keyboard support mechanism. -20° to +10° tilt range. Accommodates left and right hand positioning. Provides a super slim profile for leg clearance. Height range from +2 3/8" to -6 1/2". 21" deep track length. 27"W×11"D. Black.

ORDER NUMBER	UNIT
KPSF02	EA



E EXPONENT® UNDERDESK KEYBOARD DRAWER

Expand your work area. 3 height adjustments. Accommodates standard keyboards up to 530 mm wide (20 3/4"). Easily mounts under desk with pre-assembled railings.

ORDER NUMBER	DESCRIPTION	UNIT
56316	13"W×21.65"D×1.18" H	EA

G KENSINGTON® MODULAR PLATFORM WITH SMARTFIT® SYSTEM

Fits any size desk space. Use all 3 platforms for a large mousing area or remove a platform to fit just the keyboard. Adjusts in height up to 6", tilts +/- 15° and rotates 360°. Every SmartFit® product includes a hand chart to indicate the specific SmartFit® colour setting that will deliver optimum ergonomic comfort. Easy colour-coded window lets you adjust the unit instantly to your unique SmartFit® comfort colour.

ORDER NUMBER	DESCRIPTION	UNIT
K60718USF	21"W×11"D	EA



B HORIZON® JIVE ARTICULATING KEYBOARD TRAY

Height adjustment of 8 1/2" (2 1/2" above). Tilt adjusts +10° to -15°. Track length 21" with 360° swivel mount. Includes 26" Gelfoam™ palm/wrist rest and cord management rails. Steel platform. 26" W×11 1/2"D.

ORDER NUMBER	UNIT
JV-01	EA

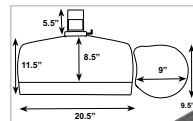

D HORIZON® JAZZ™2 KEYBOARD PACKAGE

Features Lift n' Lock height adjustments and Dial Tilt angle adjustment with position indicator, on a glide track with 360° swivel. 20 1/2" tray features anti-skid pads and 20" gelfoam palm/wrist support. Separate clip-on swivel/tilt mouse platform is lockable in 7 positions and clamps anywhere on the keyboard platform. Height adjustment of 8 3/8" (2 3/8" above). Tilt adjusts +10° to -20°. 360° swivel mount. Includes removable 20" gel wrist support. Black.

ORDER NUMBER	UNIT
JZ-02	EA



F FELLOWES® OFFICE SUITES™ DELUXE KEYBOARD DRAWER WITH MICROBAN®

Three heights for individual comfort and work position. Ball-bearing tracks ensure smooth drawer movement. Mouse tray mounts to either the right or left side and slides underneath the tray for storage. Features soothing wrist support. 31 1/2"W×11 3/8"D.

ORDER NUMBER	UNIT
8031201	EA





NEW!

A ACER® V227Q BBI 21.5" W LED MONITOR

21.5". 3,000:1 Contrast Ratio. 4 Ms response time. 1920 x 1080 dpi. VGA, HDMI. 3-year limited warranty.

ORDER NUMBER	UNIT
UM.WV7AA.B01	EA



B ACER B227Q 22" W LCD MONITOR

Ideal for office environments, libraries and computer labs. 22W" LCD. 1,000:1 Contrast Ratio. 1920x1080 dpi. VGA, HDMI®, DisplyPort connectors. 4 Ms response time. 3-year limited warranty.

ORDER NUMBER	UNIT
UM.WB7AA.002	EA



NEW!

C ASUS VT229H 21.5" TOUCHSCREEN MONITOR

Full HD IPS technology with stunningly wide 178° viewing angles. 21.5". 100000000:1 ASCR. 1920x1080 dpi. 10-point multi-touch capacity delivers smooth and durable touch experience. 5 Ms response time. 3-year warranty.

ORDER NUMBER	UNIT
VT229H	EA



D ACER® V246HQL BID 23.6" W LCD MONITOR

This sturdy monitor has a wide array of ports to connect many types of devices and do more at once. 23.6" W LCD. 3,000:1 Contrast Ratio. 1920x1080 dpi. Monitor features Acer eColor technology for striking visuals. 5 Ms response time. 3-year limited warranty.

ORDER NUMBER	UNIT
UM.UV6AA.002	EA



E ACER® B247Y BMIPRX 23.8" W LCD MONITOR

Ergonomic stand and wide range of color-enhancing technologies. 23.8" W LCD. Full HD Contrast. 1920x1080 dpi. Features In-plane Switching (IPS) Technology. 4 Ms response time. Limited warranty.

ORDER NUMBER	UNIT
UM.QB7AA.003	EA



F ACER SA270 27" W LCD MONITOR

Ideal for office environments, libraries and computer labs. 27W" LCD. 1,000:1 Contrast Ratio. 1920x1080 dpi. Display port and HDMI® connectors. 1 Ms response time. 3-year limited warranty.

ORDER NUMBER	UNIT
UM.HS0AA.B03	EA



G 3M™ PRIVACY FILTERS FOR NOTEBOOKS & MONITORS

Don't let visual hackers make off with valuable information. Effective "black out" privacy for side angle views, clear, crisp image clarity, and helps protect screen from everyday dust, dings and scratches. Attaches easily, removes cleanly.

ORDER NUMBER	DESCRIPTION	UNIT
1 PF156W9B	Fits most 15.6" screens, 13 ³ / ₁₆ "x7 ³ / ₁₆ "	EA
2 PF215W9B	Fits most 21 1/2" screens, 18 ³ / ₄ "Wx10 ⁹ / ₁₆ "H	EA
3 PF240W9B	Fits most 24" screens, 20 ⁹ / ₁₆ "Wx11 ¹³ / ₁₆ "	EA



NEW!

H ASUS VA325H 31.5" WIDESCREEN LED MONITOR

Asus exclusive SplendidPlus and VividPixel technology optimizes the picture for the finest image and colour quality. 31.5" LED. 100000000:1 ASCR. 1920x1080 dpi. Stereo Speakers 2W x 2 Stereo RMS. 5 Ms response time. 3-year warranty.

ORDER NUMBER	UNIT
VA325H	EA

Computer Accessories – monitor arms



A DAC® HEIGHT ADJUSTABLE ARTICULATING MONITOR ARMS

Rotate monitor 360° for portrait or landscape viewing. Rapid height adjustment. Tilt +/- 15°. Post height is 16". Supports monitors 13" to 27" up to 22 lbs. Includes T-bar, clamp base, 2 cable clips and an Allen key.

ORDER NUMBER	DESCRIPTION	UNIT
1 61754-02190	Single arm (MP-199)	EA
2 61754-02191	Double arm (MP-200)	EA



B ACTIVERGO™ MONITOR ARMS

Quality, function, adjustability. Steel structure, powder coated. Fits most 13" to 27" monitors VESA mount plate for 75mm and 100mm. Clamp or Grommet mount (included). 19.8 lb capacity per monitor arm. 360° swivel with a 180° lock-out option. Black.

ORDER NUMBER	DESCRIPTION	UNIT
1 AEB-17HA	Single arm	EA
2 AEB-27HA	Dual arm	EA



C ACTIVERGO™ MONITOR ARMS

For vertical or horizontal use. Built-in spring tension gauge adjusts for various weight loads, maximum weight capacity of 2.7kg/6lbs - 9 kg/19.8 lbs per arm and fits most screen sizes 17 - 32". Monitor can rotate 360° and swivel +/-90°, tilt adjusts +/-55° and accommodates flat & curved monitors. Clamp or grommet mount (both included). Cable management system and detachable VESA plate for easy installation of monitor.

ORDER NUMBER	DESCRIPTION	UNIT
1 AEG-12HA	Single arm	EA
2 AEG-24HA	Double arm	EA



D ACTIVERGO™ MONITOR ARMS

Quality, function, adjustability. Steel structure, powder coated. Clamp or grommet mount (both included). Fits most 13" to 27" monitors. VESA Standard brackets. 17-3/4" height range. 17.6 lb capacity per monitor arm. 16 3/4" arm extension. 5-year warranty.

ORDER NUMBER	DESCRIPTION	UNIT
1 AEG-15	Single arm	EA
2 AEG-20	Double arm	EA



E 3M™ DUAL MONITOR MOUNT

Easily clamps to surfaces up to 3 1/2" thick. Adjust to 15" high. Rotates 360° portrait or landscape. Tilt +/- 45° forward or back. Pans left or right +/-90°. For monitors up to 20 lbs (28 1/2"W). VESA mount plate for 75mm and 100mm. Cable management system included.

ORDER NUMBER	UNIT
MM200B	EA



F HDL® FINGER TOUCH PNEUMATIC MONITOR ARMS

Easy to manoeuvre with finger touch height adjustment. VESA mount and quick release for up to 32" monitors with 24" arm extension. Desk clamp and/or grommet mount included. 14" height adjustment range, from 5"-19". 90° monitor tilt and 90° VESA rotation. 19.8 lb capacity per arm.

ORDER NUMBER	DESCRIPTION	UNIT
1 100-MA1B-BL	Single arm, Black	EA
2 100-MA1B-SL	Single arm, Silver	EA
3 100-MA2B-BL	Dual arm, Black	EA
4 100-MA2B-SL	Dual arm, Silver	EA

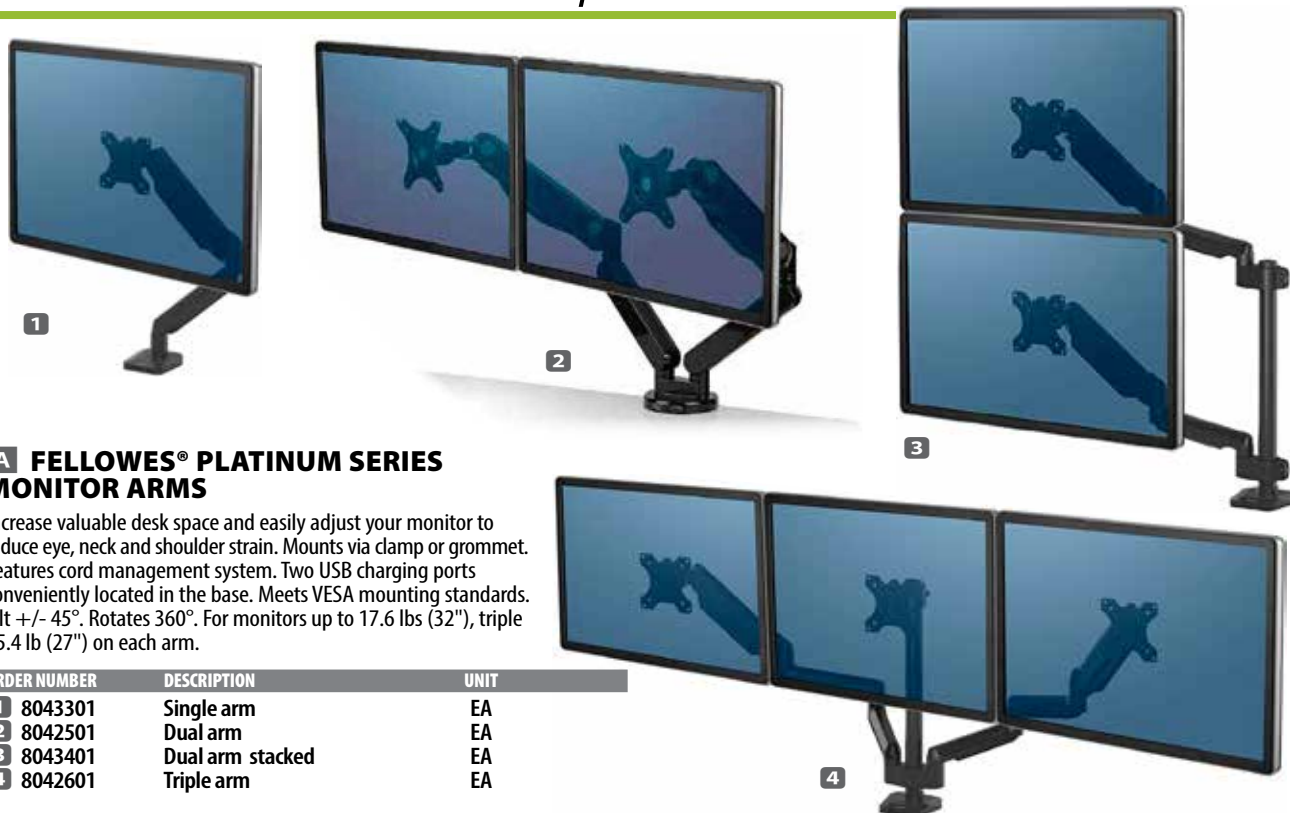

A FELLOWES® PLATINUM SERIES MONITOR ARMS

Increase valuable desk space and easily adjust your monitor to reduce eye, neck and shoulder strain. Mounts via clamp or grommet. Features cord management system. Two USB charging ports conveniently located in the base. Meets VESA mounting standards. Tilt +/- 45°. Rotates 360°. For monitors up to 17.6 lbs (32"), triple 15.4 lb (27") on each arm.

ORDER NUMBER	DESCRIPTION	UNIT
1 8043301	Single arm	EA
2 8042501	Dual arm	EA
3 8043401	Dual arm stacked	EA
4 8042601	Triple arm	EA

B FELLOWES® LAPTOP ARM ACCESSORY

Create a more productive dual-display workspace that raises your laptop and monitor off of your work surface. Allows you to lift, lower, tilt, pan or rotate your laptop into the perfect ergonomic position. Non-slip, ventilated base allows for secure and long-term use. Supports laptops up to 17"/15 lbs. Compatible with standard VESA mounting brackets.



ORDER NUMBER	UNIT
8044101	EA

C FELLOWES® PROFESSIONAL SERIES FREESTANDING DUAL MONITOR ARM

Creates a multi-display productive workspace and positions your monitors to reduce eye, neck and shoulder strain. Freestanding design allows dual monitors to be used in spaces that do not allow a clamp or grommet mount. Low profile and weighted base provide enhanced stability. The intuitive cord management system minimizes clutter. Meets VESA mounting standards. Holds 27" monitors up to 17.6 lbs. Tilt +/- 30°.

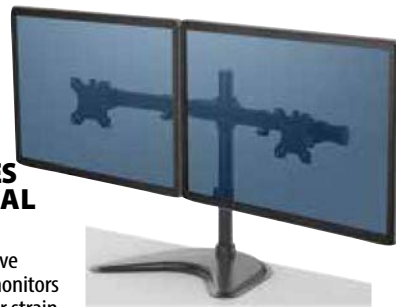

ORDER NUMBER	UNIT
8043701	EA

NEW!

D KENSINGTON® SMARTFIT® ERGO EXTENDED MONITOR ARM

The SmartFit® system makes finding the right height for maximum comfort as easy as 1-2-3. Simply match your hand size to the colour on the provided chart, set the height to your colour, and you're done. Wide adjustment range delivers ±90° swivel, ±180° rotation (for landscape or portrait orientation), and ±45° monitor tilt adjustment for ergonomic comfort. Cable management system for a clutter-free desktop. Extendable arm allows up to 15 7/10" distance adjustment. VESA. Includes C-clamp and grommet fastener. Black.

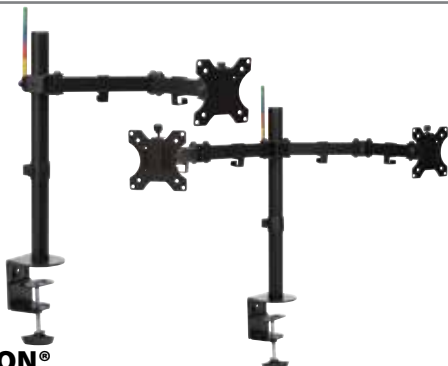

ORDER NUMBER	DESCRIPTION	UNIT
1 K55408WW	Single, for monitors up to 17.6 lbs/34"	EA
2 K55409WW	Dual, for monitors up to 17.6 lbs/32" per arm	EA

E HORIZON® ECONOMY MONITOR HOLDER

Height, reach, angle, tilt and portrait/landscape adjustable. 14½" height range. Fits most monitors 13"-27". Clamp or grommet style mounting. VESA Standard brackets (75mm and 100mm) for mounting monitors. 17.6 lb. capacity. Steel structure, powder coated black finish. 13" arm extension.

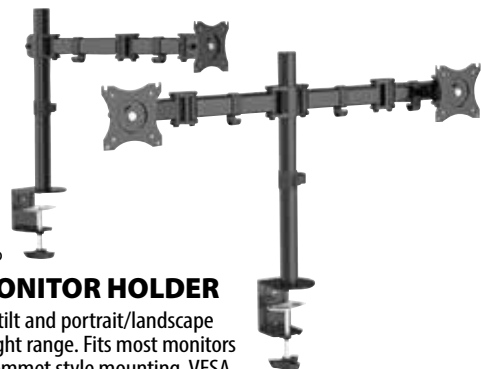

ORDER NUMBER	DESCRIPTION	UNIT
1 AEB-15	Single arm	EA
2 AEB-20	Double arm	EA

Computer Accessories – monitor stands and risers



A DAC® STAX™ CONVERTIBLE MONITOR STAND

Multifunction monitor riser, laptop and printer stand with storage space underneath. Contains a minimum of 30% recycled content. Height and angle adjustable. Monitor riser offers 4 adjustable heights from 1" to 4¾", laptop stand offers 5 extra angle adjustable heights from 3½" to 5¾". Includes cable clip. 66 lb capacity. 15½"W×10¾"D×4¾"H. Black.

ORDER NUMBER	DESCRIPTION	UNIT
61754-02260	MP-219	EA



C WINNABLE® MESH MONITOR STAND

Add a clean, distinctive look to any office. Mesh enamelled wire. Includes letter size pullout tray for papers and side storage compartments. 20"W×11¾"D×5¾"H. Black.

ORDER NUMBER	UNIT
14600	EA



NEW!

E DAC® PORTABLE NOTEBOOK STAND

Six height choices to elevate your device to the perfect eye level. Forward-tilt angle offers an open space for device ventilation. Compatible with notebooks up to 15.6" and 20 lbs. Black. Compact and portable, folds to a flat pad. Non-skid silicone protectors keep laptop in place, 9¾"W×9"D×3" to 5"H

ORDER NUMBER	DESCRIPTION	UNIT
61754-21688	(MP-224)	EA



NEW!

G DAC® ADJUSTABLE NOTEBOOK STAND

Three height and angle adjustments to maximize your comfort. Ventilated platform design helps keep laptop cool. Non-skid feet help keep stand in place. Six slots keeps your cords in connection ready position. Compatible with notebooks up to 18". 12"W×11¾"D×2" to 2⁹/₁₀"H. Black.

ORDER NUMBER	DESCRIPTION	UNIT
61754-02177	(MP-195)	EA



B FELLOWES® SMART SUITES™ CORNER MONITOR RISER

Elevates display to comfortable viewing height to help prevent neck strain. Unique shape fits neatly into desk corner to maximize workspace. Stows laptop or documents underneath to keep desk clutter-free. Three height adjustments for customizable viewing. 19¾"W×12"D

ORDER NUMBER	UNIT
8020101	EA



D EXPONENT® LAPTOP RISER

Metal riser elevates laptop for enhanced viewing comfort. Cooling vent helps dissipate laptop heat. Non-skid pads, top and bottom, prevent slippage. Supports laptops up to 17" or a maximum of 25 lbs.

ORDER NUMBER	DESCRIPTION	UNIT
50601	Black	EA



F 3M™ ADJUSTABLE NOTEBOOK RISER

Use with an auxiliary keyboard and mouse for a practical alternative to a traditional desktop monitor. Height adjusts from 4" to 6" in half-inch increments. Black.

ORDER NUMBER	UNIT
LX500	EA



NEW!

H FELLOWES® DESIGNER SUITES™ MONITOR RISER

Elevates display to comfortable viewing height to help prevent neck strain. Stow laptop or documents underneath to keep desk clutter-free. Storage tray organizes business essentials. Height adjusts up to 1⁵/₈" (total range between 4³/₈" and 6"). Supports monitors up to 21" or 40 lbs. 16"W×9³/₈"D×4³/₈"H. Black Pearl.

ORDER NUMBER	UNIT
8038101	EA

NEW!



A BOSTITCH® KONNECT™ WIRELESS CHARGING MONITOR STAND

Combats neck and eye strain by elevating your screen's viewing point. Built-in wireless charging pad for Qi-enabled devices. Storage drawer organizes cords, notepads and other small accessories. Two height adjustable options. Supports monitors up to 33 lbs. 24"W×8"D×3" to 4"H. Light Wood and White.

ORDER NUMBER	DESCRIPTION	UNIT
STND-2408WH	Black	EA

B EXPONENT® STACKABLE MONITOR STAND



Accommodates letter size paper. Support 17" monitors up to 55lbs. 12"W×13"D×1¼"H. Sold individually.

ORDER NUMBER	UNIT
56208	EA



C DAC® FLAT PANEL MONITOR RISER

Reduce muscle fatigue and eye strain by setting your monitor to a comfortable position. Height adjustable from 1" to 4.8". Heavy duty ABS plastic construction supports up to 66 lbs. (30 kg). Lifetime warranty; Black.

ORDER NUMBER	DESCRIPTION	UNIT
1 61754-02161	(MP-107) 13"W	EA
2 61754-02240	(MP-212) 22"W	EA
3 61754-02184	(MP-197) Corner	EA

D KENSINGTON® BASIC MONITOR STAND

Durable, stylish, design with the ergonomic benefits of raising your monitor height. Extra wide platform offers an organized work environment with plenty of space underneath to store a full-size keyboard and accessories. Steel base elevates your monitor to optimal viewing height to promote a healthy posture and increase productivity. Supports monitors up to 32" and 44 lbs. 20"W. Black.

ORDER NUMBER	UNIT
K55726WW	EA



E 3M™ ADJUSTABLE MONITOR STAND WITH USB HUB

Integrated USB hub allows you to connect devices to your computer keeping everything you need right at your fingertips. Three USB 2.0 and one USB 3.0 ports. Height adjusts from 2¾" to 3½". Holds up to 33 lbs. 21½"W×9½"D×3½"H.

ORDER NUMBER	UNIT
MS100B	EA



F DAC® NOTEBOOK STAND WITH USB HUB

Help keep laptops running cooler. Silicone surface and base keeps laptop in place. Four USB 3.0 ports for fast data transfer and easy charging. Compatible with laptops up to 15.6" and 20 lbs. 12½"W×9¾"D×3"H. Black.

ORDER NUMBER	DESCRIPTION	UNIT
61754-21680	MP-220	EA



G EXPONENT® MOBILE CPU STAND

Heavy duty construction and two locking casters provide stability. Adjustable width from 6" to 10¼". Black.

ORDER NUMBER	UNIT
51000	EA



Computer Accessories – backrests and footrests



A KENSINGTON® ERGONOMIC MEMORY FOAM SEAT CUSHION

Ergonomic design promotes healthy posture, improves circulation and provides tailbone & lower back support. Anti-slip backing prevents sliding using a silicone friction grip. Includes a removable cover and convenient carrying strap. Black.

ORDER NUMBER	UNIT
K55805WW	EA



B FELLOWES® PROFESSIONAL SERIES BACK SUPPORT

Lower lumbar support with three memory foam sections conforms comfortably to natural body curvature. Tri-Tachment™ system ensures stability and eliminates the need for readjustment. Microban® antimicrobial protection. 14½"W×2"D×15"H. Black



ORDER NUMBER	UNIT
8037601	EA

C KENSINGTON® MEMORY FOAM BACK REST

Provides full back support with high-density, viscoelastic, temperature and pressure-sensitive memory foam, moulds to body shape, dissipates pressure to provide maximum comfort. Easy-to-adjust straps allow virtually universal chair fit. Removable, washable fabric cover included. Black.



ORDER NUMBER	UNIT
L82025F	EA

D KENSINGTON® SMARTFIT® CONFORM BACKREST

Take sitting comfort to a new level, with patented back support technology that works in nearly any type of chair. The SmartFit system for customizing the back rest height to your specific comfort for maximum spine and lumbar support. Ventilated back panels conform to your body type through four independent springs that articulate when you shift posture. Black.



ORDER NUMBER	UNIT
K60412WW	EA



E FELLOWES® I-SPIRE™ SERIES LUMBAR CUSHION

Breathable mesh fabric enhances personal comfort. Adjustable strap with durable buckle hold cushion in place. Supports lower back for enhanced comfort while seated and helps reduce back tension. 14"W×3"D×6"H.

ORDER NUMBER	DESCRIPTION	UNIT
1 9472702	Black	EA
2 9311603	Grey	EA

NEW!

F FELLOWES® HEAT AND SOOTHE BACK SUPPORT

Gel lumbar pack conforms to individual users for the ultimate flexible back support. Can be heated in microwave oven or cooled in refrigerator to adjust temperature. Slim profile, soft touch fabric exterior. Adjustable strap with buckle fits most modern office chairs. 14½"W×3"D×13⅝"H.



ORDER NUMBER	UNIT
9190001	EA



G FELLOWES® OFFICE SUITES™ MESH BACK SUPPORT

Reduces tension by maintaining the lumbar curve of your lower back; gently conforms to your body's contours to provide uniform support. Mesh fabric allows air flow to increase comfort. Easily attaches to any chair. 17¾"W×5"D×15"H.

ORDER NUMBER	UNIT
8036501	EA

H FELLOWES® OFFICE SUITES™ MESH BACK SUPPORT

Forms to your body and provides maximum support with additional padded features. Mesh fabric enhances personal comfort & air flow. Eliminate the need to re-adjust with the Tri-tensioning™ attachment. Easily attaches to any chair. Black. 17"W×5½"D×20"H.



ORDER NUMBER	UNIT
9191301	EA



A FELLOWES® CLIMATE CONTROL FOOTREST

Versatile unit works as a footrest or free-standing climate control. Features 3 temperature settings: cool fan, low heat and high heat. Adjustable footrest features 2 height adjustments 5½" or 6½" and adjustable tilt from 5°, 14° or 20°. Massage bumps help relieve stress. 16⅝"W×10¼"D×5½"H.

ORDER NUMBER	UNIT
8040901	EA



B FELLOWES® PROFESSIONAL SERIES™ ULTIMATE FOOT SUPPORT

Elevates feet and legs to relieve lower back pressure. Scissor motion height adjustment provides three platform heights – 4", 5½" and 6½". Tilts up to 25°. Surface massage bumps relieve stress. No fixed angle allows for rocking motion to improve circulation. Black/grey. 17¾"W×13¼"D×4"H.

ORDER NUMBER	UNIT
8067001	EA



C SAFCO® RESTEASE™ ADJUSTABLE FOOTREST

4 angle adjustments from 6° to 25°; height adjusts from 3¼" to 5". Integrated anti-slip rubber mat on platform. 2-tone black with silver accents. 15½"W×13¾"D×3¼"-5"H.

ORDER NUMBER	UNIT
2120BL	EA



D FELLOWES® STANDARD ADJUSTABLE FOOTREST

Dual-position height adjustment allows legs to stretch for increased circulation. Height adjustments of 3½" and 4⅞". Contains 89% post-consumer recycled material. 16¾"W×12"D×3½"H.

ORDER NUMBER	UNIT
48121	EA



E EXPONENT® ADJUSTABLE FOOTREST

Unique design helps relieve fatigue while providing the correct foot support. Features 6 height adjustments from 5° to 14°. Non-skid rubber feet in front. Textured surface massages feet helping to improve leg circulation. Heavy-duty plastic. 18⅞"W×15⅜"D×2⅝ to 5"H.

ORDER NUMBER	UNIT
51102	EA



F KENSINGTON® SOLESAVER FOOTREST

Helps to reduce pressure on the lower back and alleviates discomfort from sitting. Features 3 angled adjustments from 10°, 15° and 20°. Textured foot-grip platform. 14"W×17¾"D×3"H.

ORDER NUMBER	UNIT
K56152US	EA



G 3M™ FOOT REST FOR HEIGHT-ADJUSTABLE DESKS

Designed for use with height adjustable desks to increase comfort when sitting or standing. Encourages movement of legs and feet throughout the day. Features two different positions: rocking to move your feet back and forth while sitting and stationary to place your feet on while sitting or one foot at a time while standing. 19½"W×11½"D×4⅞"H. Black.

ORDER NUMBER	UNIT
FR200B	EA



H KENSINGTON® ROCKING FOOTREST

Promotes movement and stretching while sitting or standing. Strong, non-slip extruded rotating aluminum bar helps to improve circulation and relieve pressure for better health and all-day comfort. 25¾"W×10⅞"D×5⅞"H. Grey.

ORDER NUMBER	UNIT
K58303WW	EA

Computer Accessories – copyholders

**A FELLOWES® COPYHOLDER**

Letter size capacity for desktop use. Adjustable angle. The movable line guide is also adjustable in depth to hold reports up to 3/8" thick or as little as one sheet. Black

ORDER NUMBER	UNIT
77511-21106	EA

**B KENSINGTON® OFFICE ASSIST™ MULTI-FUNCTION COPYHOLDER**

Sturdy, dual 50-page copyholder with clip in portrait or landscape orientation. Includes magnetic dry-erase whiteboard, cell phone holder with built-in cable management for charging, and pen holder. Foldable legs hold thick books (up to 6.6lbs).

ORDER NUMBER	UNIT
K55910WW	EA

**C WINNABLE® MESH COPYHOLDER**

Tent-shaped, with 2" bottom front document lip. Black mesh construction; includes 2 magnets to hold documents in place. 11" H×9" W.

ORDER NUMBER	UNIT
70001	EA

**D 3M™ IN-LINE DOCUMENT HOLDER**

Stand-alone holder can be placed between keyboard and monitor to reduce strain and enhance overall comfort. Skid-free base; wide, transparent back plate. Elastic line guide; angle and height adjustable; capacity: 150 sheets. 12" H×15" W×3" D.

ORDER NUMBER	UNIT
DH630	EA

**E 3M™ IN-LINE WIDE DOCUMENT HOLDER**

With 18" W transparent back plate, weighted base and non-slide grooved shelf with raised edge that accommodates books, catalogues and landscape documents. Elastic line guide; angle and height adjustable; capacity: 300 sheets. 11" H×18" W×4" D.

ORDER NUMBER	UNIT
DH640-AM	EA

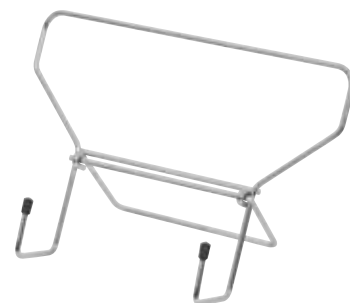
**F MERANGUE WIRE BOOK HOLDER**

Supports books, papers and tablets at a comfortable reading angle. 10½" W×6¼" H. Chrome finish.

ORDER NUMBER	UNIT
1025-7260-00-000	EA

**G DAC® EUROHOLDER COPYHOLDER**

The spring-loaded line guide mounts for left- or right-handed users. Non-glare, anti-static and nonmagnetic. Accommodates letter size documents. Black.

ORDER NUMBER	UNIT
61754-17008	EA

**H EXPONENT® ERGO EASEL COPYHOLDER**

Desktop easel type copyholder. Softly curved shape helps keep the paper easy to read for typing or working from a hand drawn original. Clear line guide. Supports letter or legal size paper.

ORDER NUMBER	UNIT
56109	EA

**I DAC® EUROHOLDER WEIGHTED BASE COPYHOLDER**

The spring-loaded line guide mounts for left- or right-handed users. Faceplate swivels left to right. Accommodates letter or A4 paper. Height adjustable up to 4". Black.

ORDER NUMBER	UNIT
61754-17009	EA



A EMZONE NO DRIP SCREEN CLEANER

Innovative non-drip formula removes smudges, oil and dirt without leaving any streaks or residue on electronic devices. Unique anti-static, protective coating helps reduce fingerprints and dust from collecting on screens. Ammonia-free. Includes a microfibre screen cleaning cloth in the cap.



ORDER NUMBER	DESCRIPTION	UNIT
60480-47046	14 oz. can	EA



B EMZONE AIR DUSTER

Removes dust, dirt and lint. Cleans computers, keyboards, printers and a variety of office machines. Ideal for hard-to-reach areas. Extension tube included. 284g/10 oz. can.



ORDER NUMBER	UNIT
60480-47020	EA



C EMZONE MINI AIR DUSTER

Blasts away dust, dirt and lint. Leaves zero residue, is VOC compliant and moisture free. 100 g/3.5 oz.



ORDER NUMBER	UNIT
1 60480-47035	EA
2 60480-47036	2/PK

D EXPONENT® LCD SCREEN CLEANING WIPES

Anti-static, non-streak, biodegradable and individually wrapped.



ORDER NUMBER	UNIT
77500	25/PK

E EMZONE SCREEN CLEANING WIPES

Anti-static wipes clean dirt, smudges and fingerprints from computer monitors, LCD screens, laptops, televisions, handheld devices and other electronic equipment. Lint-free, moist non-drip; non-flammable and alcohol free.



ORDER NUMBER	DESCRIPTION	UNIT
1 60480-47044	Box of 50	BX
2 60480-47090	Tub of 100	EA



F EMZONE NO DRIP SCREEN CLEANER FOAM KIT

The non-drip foam formula helps remove smudges and dirt without streaking or scratching sensitive surfaces. Includes two 2.1 oz cans of screen cleaner foam and two 11 1/8" x 7" microfibre cloths.



ORDER NUMBER	UNIT
60480-47072	PK



G EMZONE SCREEN CLEANER & MICROFIBRE CLOTH VALUE PACK

Anti-static alcohol and ammonia free screen cleaner (118 ml/4 fl oz) with 30 cm x 20 cm (12" x 8") microfibre cloth.



ORDER NUMBER	UNIT
60480-47066	PK

H EMZONE MICROFIBRE SCREEN CLEANING CLOTHS

Pack of three 30 cm x 20 cm (12" x 8") microfibre lint-free cloths that gently dust and clean.



ORDER NUMBER	UNIT
60480-47067	3/PK

I EMZONE ALL-PURPOSE SURFACE CLEANING WIPES

Clean dirt, dust, grime and smudges. Moist, lint free; tub contains 100 wipes.



ORDER NUMBER	UNIT
60480-47091	EA

Computer Accessories – surge protectors



A WOODS® 6-OUTLET POWER STRIP

Resettable circuit breaker switch. 6 outlets. White.

ORDER NUMBER	DESCRIPTION	UNIT
1 41366	2' cord	EA
2 41434	6' cord NEW!	EA

560 joules



C WOODS® 6-OUTLET SURGE PROTECTOR

Six outlets with 560 Joules, 1.5' cord and overload protection.

ORDER NUMBER	UNIT
41345C	EA

1180 joules



E WOODS® 6-OUTLET SURGE PROTECTOR

Features 1180 Joules, safety covers, a super long 15' cord and overload protection.

ORDER NUMBER	UNIT
41515	EA

1440 joules



G WOODS® 7-OUTLET ELECTRONICS SURGE PROTECTOR

Surge and overload protection, child safety outlet covers. Space-saving flat plug. cULus listed. 7 outlets. 1,440 Joules. 10' long cord. \$150,000 connected equipment warranty.

ORDER NUMBER	UNIT
41496	EA

510 joules



B WOODS® 6-OUTLET SURGE PROTECTOR

Six outlets with 510 Joules, safety covers, 3' cord and overload protection.

ORDER NUMBER	UNIT
41492	EA

560 joules



D WOODS® CORNER POWER STRIP

Unique integrated cord tuck keeps it tight against the wall. Lit on/off switch with overload protection and rotating safety covers. 15 amps. 560 Joules. 120 V extension cord. 4' cord length. 1-year warranty. White.

ORDER NUMBER	DESCRIPTION	UNIT
41379	4-outlet surge with 2 USB ports	EA

1440 joules



F WOODS® 6-OUTLET ELECTRONICS SURGE PROTECTOR

Surge and overload protection, child safety outlet covers. Space-saving flat plug. cULus listed. 6 outlets with 1 adaptor outlet. 1,440 Joules. 4' long cord. \$150,000 connected equipment warranty.

ORDER NUMBER	UNIT
41494	EA

1780 joules



H WOODS® ENERGY SAVING 6-OUTLET SURGE PROTECTOR

Features auto turn off 4 outlets to eliminate phantom power loss, 1780 Joules, 2 constant outlets, 1 adapter spaced outlet, safety covers, 3' cord with right angled plug and overload protection.

ORDER NUMBER	UNIT
41704	EA

1780
joules



A WOODS® 7-OUTLET HOME OFFICE SURGE PROTECTOR

Surge protection, child safety outlet covers, a space-saving flat plug and resettable circuit breaker switch. cULus listed. 7 outlets. 1,780 Joules. EMI/RFI Noise Filter. 4' long cord. \$150,000 connected equipment warranty.

ORDER NUMBER	UNIT
41626	EA

2160
joules

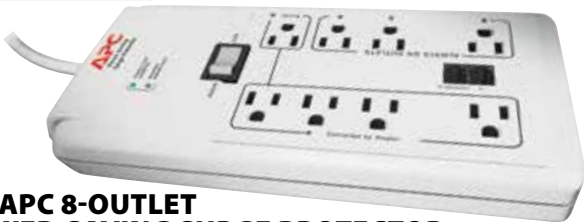

C APC 8-OUTLET POWER-SAVING SURGE PROTECTOR

Features Phone/Cable/Ethernet line protection, power-saving outlets, fail safe mode disconnects if compromised. cULus listed. 8 outlets. 2,160 joules. EMI/RFI Filtering. Network/Phone Protection. 6' cord length. 1-in/1-out modem/fax. Lifetime \$150,000 warranty.

ORDER NUMBER	UNIT
P8GT	EA



NEW!

E APC® BACK-UPS™

Capable of powering wireless networking equipment for 2 plus hours after safely shutting down your PC or other high powered devices. 3-year warranty, \$75,000 Equipment Protection Policy.

ORDER NUMBER	DESCRIPTION	UNIT
BACKUP TIME AT 180W LOAD: 5.8 MINUTES		
2 surge-protected outlets, 4 battery backup outlets		
1 BE425M	255 watts / 425 VA	EA
BACKUP TIME AT 180W LOAD: 10.3 MINUTES		
2 surge-protected outlets, 5 battery backup outlets, 1 USB charging port		
2 BE600M1	330 watts / 600 VA	EA
BACKUP TIME AT 180W LOAD: 13.5 MINUTES		
4 surge-protected outlets, 4 battery backup outlets		
3 BE650G1	390 watts / 650 VA	EA
BACKUP TIME AT 180W LOAD: 16.1 MINUTES		
3 surge-protected outlets, 6 battery backup outlets, 2 USB charging port		
4 BE850G2	450 watts / 850 VA	EA

1780
joules



B WOODS® 6-OUTLET USB SURGE PROTECTOR AND CHARGER

1 spaced adaptor outlet and 2.4 Amp USB. Right angle plug. Child safety covers. 6 outlets. 1,780 Joules. 4' long cord. \$150,000 connected equipment warranty.

ORDER NUMBER	UNIT
41495	EA

3540
joules



D WOODS® 8-OUTLET MULTIMEDIA SURGE PROTECTOR

Features 2.4 Amp USB Charging, cable/satellite protection, 3540 Joules, 6' Cord with flat plug, 3 adaptor spaced outlets, safety covers and overload protection.

ORDER NUMBER	UNIT
41629	EA



F APC® PRO SERIES BATTERY BACK-UPS®

Provides protection of connected equipment from power surges on the data lines and reduces line noise that can cause data loss and keyboard errors. LCD interface has text and mimic diagrams that display modes of operation, system parameters and alarms. 10 Outlets and 2 USB Charging Ports. Includes coaxial cable, USB cable and user manual. Standard 3-year warranty.

ORDER NUMBER	DESCRIPTION	UNIT
BACKUP TIME AT 180W LOAD : 23.1 MINUTES		
1 BR1000MS	1000 VA/600 W	EA
BACKUP TIME AT 180W LOAD : 44.3 MINUTES		
2 BR1500MS2	1500 VA/900 W	EA

Computer Accessories – wall taps and extension cords

A WOODS® 6-OUTLET WALL TAP

Easily adapts 2 receptacles to 6. Features rotating safety covers. White.



ORDER NUMBER	DESCRIPTION	UNIT
41196	6-outlet	EA

1000 joules

C WOODS® 6-OUTLET/ 2-USB PORTS WALL TAP SURGE PROTECTOR

Built-in cradle holds the device while charging. Fold-out wire wrap keeps cords neat and tidy. Features two 2.4 amp USB ports and two grounded power outlets. EZ pull design. 1,000 joules. \$100,000 connected equipment warranty. White.



ORDER NUMBER	UNIT
41079	EA

E WOODS® WALL TAP

Space-saving side entry outlet design allows for furniture to be moved closer to wall. Safely converts 2 grounded outlets to 6. Features a phone cradle, wire wrap and EZ-pull. White.



ORDER NUMBER	DESCRIPTION	UNIT
41261	6-outlet	EA

500-1440 joules

G WOODS® SWIVEL SURGE PROTECTORS

Six outlet space-saving swivel surge protector features 3 outlets that rotate 90 degrees. EMI/RFI noise filter.



ORDER NUMBER	DESCRIPTION	UNIT
1 41423	1440 Joules, No USB	EA
2 41424	500 Joules, Two 2.4A USB Outlets	EA

B WOODS® HOUSEHOLD EXTENSION CORDS

For indoor or audio/visual use. White, 16 gauge, 13 amps, 125V.



ORDER NUMBER	DESCRIPTION	UNIT
1 540015	2 m/6.5'	EA
2 540170	4.5 m/14.7'	EA

D WOODS® OFFICE EQUIPMENT EXTENSION CORDS

For indoor medium duty use. Grey 14 gauge, 15 amps, 125V extension cords.



ORDER NUMBER	DESCRIPTION	UNIT
1 542703	3 m/9.8'	EA
2 64790401	4.5 m/14.7'	EA

F WOODS® LIGHT DUTY OUTDOOR EXTENSION CORDS

Made with specially treated, double insulated jackets. Cord is CUL approved, weatherproof, UV resistant and flexible in -40 degree weather. 16 gauge. 13 amps. Orange.



ORDER NUMBER	DESCRIPTION	UNIT
1 541522	10 m/32.8'	EA
2 541548	15 m/49.2'	EA
3 541550	15 m/49.2' with power indicator light	EA

H WOODS® POWERCADDY WITH 7.6 m EXTENSION CORD

Unwinds only as much cord as needed – eliminates tangles. With 7.6 m/24.9' cord, four grounded outlets and built-in 10-amp circuit breaker.



ORDER NUMBER	UNIT
502801	EA

NEW!

I EXPONENT® OFFICE POWER CORDS

For general office use. Three outlets. 16 gauge. 13 amp. 125 V. Black.



ORDER NUMBER	DESCRIPTION	UNIT
1 57551	3 m/9.8 ft.	EA
2 57552	4.5 m/14.7 ft.	EA

POWER YOUR PROFITABILITY



TURN BATTERIES FROM A COST CENTER INTO A COST SAVER

By conducting intensive device testing and analysis in our labs, Procell has discovered that a way to dramatically extend alkaline battery life and cut replacement costs is to engineer device-specific industrial alkaline batteries, each with unique power profiles.

THE WORLD'S FIRST DUAL PORTFOLIO OF PROFESSIONAL BATTERIES

PROCELL INTENSE POWER

- Specifically engineered to deliver precise pulses of energy while lasting longer in high-drain professional devices*

PROCELL GENERAL PURPOSE

- Completely redesigned for longer lasting*, consistent performance

By selecting the right battery to match the power needs of your commercial device, you can make all your batteries last longer*, so you replace them less often.



PROCELL[®]
PROFESSIONAL BATTERIES

*vs. prior Procell AA, AAA, C, and D

Computer Accessories – batteries

A DURACELL® ION SPEED 4000 CHARGER

Compact charger with fold-out wall plug will charge 2 "AA" batteries in an hour. 5-year storage life. Includes 2 "AA" and 2 "AAA" rechargeable batteries.



ORDER NUMBER	UNIT
CEF27CN	PK

B DURACELL® ION SPEED 1000 CHARGER

Pre-charged batteries are ready to use. With long life ion core, guaranteed five years in storage. Includes 4 "AA" rechargeable batteries.



ORDER NUMBER	UNIT
CEF14DX4N	PK



C DURACELL® RECHARGEABLE STAYCHARGED™ BATTERIES

Pre-charged batteries are ready to use. With long life ion core, guaranteed five years in storage.

ORDER NUMBER	DESCRIPTION	UNIT
1 DX1500B4N	AA	4/PK
2 DX2400B4N	AAA	4/PK

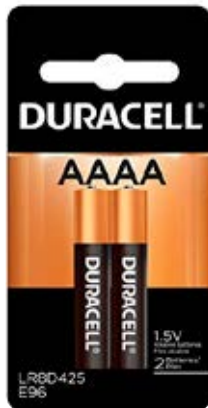

D DURACELL® COPPERTOP® ULTRA AAAA BATTERIES

These batteries last up to 50% longer in high-tech devices. Perfect for CD and MP3 players, handheld computers, toys, flash devices and digital cameras.

ORDER NUMBER	DESCRIPTION	UNIT
MX2500B2PK	AAAA	2/PK



E DURACELL® ALKALINE BATTERIES

Long Lasting Power: Up to a 10-year guarantee in storage with Duralock Power Preserve™ Technology.

ORDER NUMBER	DESCRIPTION	UNIT
1 PX76A675PK	1.5V, 76A	EA
2 MN21BPK	12V, MN21/23	EA
3 MN21B2PK	12V, MN21/23	2/PK



F DURACELL® SILVER OXIDE BATTERIES

Features DuraLock Power Preserve™ Technology. Ideal use for laser pointers, watches, cameras, alarm transmitters, calculators, blood pressure instruments, sugar level detectors, 3-year storage life.

ORDER NUMBER	DESCRIPTION	UNIT
1 D303/357PK	1.5V, 303/357	EA
2 D377BPK	1.5V, 376/377	EA
3 D389/390PK	1.5V, 389/390	EA



G DURACELL® LITHIUM BATTERIES

Long Lasting Power: Up to a 10-year guarantee in storage with Duralock Power Preserve™ Technology.

ORDER NUMBER	DESCRIPTION	UNIT
1 DLCRV3BPK	CR-V3	EA
2 DL123ABPK	123	EA
3 DL123AB2PK	123	2/PK
4 DL2032BPK	2032	EA
5 DL2016BPK	2016	EA
6 DL2025BPK	2025	EA



H DURACELL® PROCELL® LITHIUM BATTERIES

Designed for small, professional high-tech sensing devices. 3V Lithium. For watches and calculators. 7-year storage life.

ORDER NUMBER	DESCRIPTION	UNIT
1 PC2016	2016	5/PK
2 PC2025	2025	5/PK
3 PC2032	2032	5/PK
4 PC123	123	12/BX



A DURACELL® COPPERTOP® BATTERIES

#1 Trusted Brand.

ORDER NUMBER	UNIT	ORDER NUMBER	UNIT
"AAA" 10-YEAR STORAGE LIFE			
1	MN2400B2Z 2/PK	13	MN1400B2Z 2/PK
2	MN2400B4Z 4/PK	14	MN1400BKD 12/PK
3	MN2400B8Z 8/PK	"D" 10-YEAR STORAGE LIFE	
4	MN24RT12Z 12/PK	15	MN1300B2Z 2/PK
5	MN2400B16Z NEW! 16/PK	16	MN1300BKD 12/PK
6	MN2400BKD 24/PK	"6V" 5-YEAR STORAGE LIFE	
"AA" 10-YEAR STORAGE LIFE			
7	MN1500B2Z 2/PK	17	MN908 EA
8	MN1500B4Z 4/PK	"9V" 5-YEAR STORAGE LIFE	
9	MN1500B8Z 8/PK	18	MN1604B1Z 1/PK
10	MN15RT12Z 12/PK	19	MN1604B2Z 2/PK
11	MN1500B20Z 20/PK	20	MN16RT4Z 4/PK
12	MN1500BKD 24/PK	21	MN1604BKD 12/PK

B ENERGIZER® RECHARGEABLE LED LIGHT

Light turns on when the power goes out. Bright-white LED. With 2 modes: 2 hour and 45 minutes runtime on high, 15 hours on low. 1 Energizer® Recharge® NiMH battery included. Lifetime guarantee.

ORDER NUMBER	UNIT
RCL1FN2WR	EA



C DURACELL® PROCELL® ALKALINE BATTERIES

Bulk packs, ideal for office use, reduces packaging waste. Long lasting alkaline battery for a secure power source.

ORDER NUMBER	DESCRIPTION	UNIT
1	PC1500BKD AA	24/PK
2	PC2400BKD AAA	24/PK
3	PC1400 C	12/PK
4	PC1300 D	12/PK
5	PC1604BKD 9V	12/PK

D DURACELL® PROCELL® INTENSE BATTERIES

Engineered to deliver precise pulses of energy while lasting longer in high-drain professional devices such as motors, pumps or motion-sensors. 7-year storage life.

ORDER NUMBER	DESCRIPTION	UNIT
1	PX1500 AA	24/PK
2	PX2400 AAA	24/PK
3	PX1400 C	12/PK
4	PX1300 D	12/PK
5	PX1604 9V	12/PK

USB 2.0 AND 3.0 CONNECTOR TYPES



A EXPONENT® ETHERNET CATEGORY 5E PATCH CABLES

Blue cable to connect Ethernet devices.



ORDER NUMBER	DESCRIPTION	UNIT
1 57271	3'	EA
2 57277	7'	EA
3 57283	14'	EA
4 57289	25'	EA
5 57295	50'	EA

B EXPONENT® HIGH SPEED ETHERNET CABLES

Category 6e. transfers 1250 Mbps. Blue.



ORDER NUMBER	DESCRIPTION	UNIT
1 57541	7' cable	EA
2 57542	14' cable	EA
3 57543	25' cable	EA

C STARTECH USB CHARGING CABLES

Provides a reliable and simple solution for charging and syncing your mobile devices with your PC or Mac®. Aluminum-mylar foil with braided shielding.



ORDER NUMBER	DESCRIPTION	UNIT
--------------	-------------	------

SLIM MICRO TO USB CABLE

Supports high speed USB data transfer rates of up to 480 Mbps.

1 USBAUB6BK	6' cable, Black	EA
-------------	-----------------	----

LIGHTNING TO USB CABLE

Reversible 8-pin connector can be plugged into IOS-enabled devices with either side facing up. 2-year warranty.

2 USBLT1MW	3' length, white	EA
3 USBLT3MW	Slim 10' length, white	EA

E STARTECH NYLON CABLE TIES

Durable, yet pliable, 6" nylon cable ties. UL-approved.



ORDER NUMBER	UNIT
CV150	100/PK

D EMTEC™ T700 CHARGING CABLES

Sync & charge. Properly carries a 2.4 Amp charge, enough to recharge a tablet. 4' cable length.



ORDER NUMBER	DESCRIPTION	UNIT
--------------	-------------	------

1 ECCHAT700AP	USB-A to Lightning cable: compatible with Apple Lightning port	EA
2 ECCHAT700TC	USB-A to Type-C cable	EA

F BELKIN® CORD CONCEALER

Hides computer cables easily and efficiently. Designed for use on floors or countertops. Flexible material can be cut to fit to any desired length. Double-sided adhesive tape ensures that the cord concealer remains secure and flat at all times. Six-foot length.



ORDER NUMBER	UNIT
F8B023	EA



G SCOTCH® BUNDLING STRAPS

A quick, easy self-fastening organizing solution. Recloseable and adjustable. Each strap can be used multiple times. Black.

ORDER NUMBER	DESCRIPTION	UNIT
RF3710C	8"×1/2"	6/PK

H VELCRO® INDUSTRIAL STRIPS AND STRAPS

Reusable Velcro Brand® hook and loop cable ties. Keep workstations tidy and safely store extra cabling. Contains a minimum of 40% post-consumer recycled material. Black.

ORDER NUMBER	DESCRIPTION	UNIT
1 VEL-30189-CAN	Precut Strips, 2/PK 3"×1 3/4"	
2 VEL-30187-CAN	Straps 10"×1"	6/PK



I VELCRO® ONE-WRAP STRAPS

Perfect for any cable management solution. Velcro® Fasteners, 8"×1/2", assorted colours.

ORDER NUMBER	UNIT
90438	5/PK



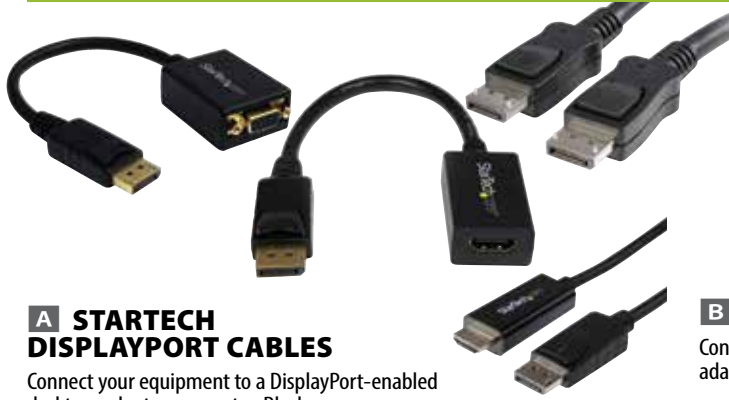

A STARTECH DISPLAYPORT CABLES

Connect your equipment to a DisplayPort-enabled desktop or laptop computer. Black.

ORDER NUMBER	DESCRIPTION	UNIT
DISPLAYPORT TO DVI VIDEO ADAPTER CONVERTER		
Supports PC resolutions up to 1920×1200; HDTV resolutions up to 1080p.		
1 DP2DVI	9.4" length, 2-year warranty	EA
DISPLAYPORT TO DVI ADAPTOR		
2 DP2DVI2	6" length, 2-year warranty	EA
3 DP2DVI2MM6	6' length, 2-year warranty	EA
DISPLAYPORT TO VGA ADAPTOR		
4 DP2VGA2	8.9" length, 2-year warranty	EA
DISPLAYPORT 1.2 TO VGA ADAPTOR		
Supports video resolution up to 1920×1200 / 1080p.		
5 DP2VGA3	3.9" length, 2-year warranty	EA
DISPLAYPORT 1.2 CABLE WITH LATCHES		
DisplayPort (VESA) certified.		
6 DISPLPORT6L	6' length, Lifetime warranty	EA
7 DISPLPORT10L	10' length, Lifetime warranty	EA
DISPLAYPORT TO HDMI CONVERTER CABLE		
Backward compatible with lower resolution displays and video sources. No power source required.		
8 DP2HDMM2MB	6' length, 2-year warranty	EA
DISPLAY PORT TO HDMI ADAPTOR		
Supports display resolutions up to 1920×1200; HDTV resolutions up to 1080p.		
9 DP2HDMI	5" length, 2-year warranty	EA
10 DP2HDMI2	8" length, 2-year warranty	EA

B STARTECH MINI DISPLAYPORT ADAPTORS

Connects Hassle-free connectivity with plug-and-play mDP to VGA video adapter. Compatible with Intel® Thunderbolt™ ports. Black.

ORDER NUMBER	DESCRIPTION	UNIT
MINI DISPLAYPORT TO VGA VIDEO CONVERTER		
Crystal clear picture quality, support for high-definition video resolutions up to 1920×1200 or 1080p.		
1 MDP2VGA	4" length, 2-year warranty	EA
MINI DISPLAYPORT 1.2 TO VGA CONVERTER		
2 MDP2VGA2	8.7" length 2-year warranty	EA
MINI DISPLAYPORT TO HDMI VIDEO ADAPTOR		
3 MDP2HDMI	5.1" length, 2-year warranty	EA
MINI DISPLAYPORT TO HDMI CONVERTER CABLE		
Astonishing video quality, support for video resolutions up to 4K at 30 Hz.		
4 MDP2HDMM2MB	2m (6.6') length, 2-year warranty	EA
MINI DISPLAYPORT TO DISPLAYPORT 1.2 ADAPTOR		
High-resolution support of up to 4k×2k.		
5 MDP2DPM6	6' length, Lifetime warranty	EA
MINI DISPLAYPORT TO DISPLAYPORT VIDEO CABLE ADAPTOR		
Easily converts from Mini DisplayPort to DisplayPort.		
6 MDP2DPMF6IN	6" length, 2-year warranty	EA
MINI DISPLAYPORT TO DVI VIDEO ADAPTOR		
Supports resolutions up to 1920×1200; HDTV resolutions up to 1080p.		
7 MDP2DVI	4" length, 2-year warranty	EA

C EXPONENT® HDMI TO HDMI CABLE

Connects digital displays such as HDTVs, plasma displays, DLP TVs, LCD TVs and projectors. Enables delivery of both high-definition video and multichannel, digital audio through one cable. Black.



ORDER NUMBER	DESCRIPTION	UNIT
1 57560	6' HDMI cable	EA
2 57561	10' HDMI cable	EA
3 57562	15' HDMI cable	EA



D EXPONENT® USB 3.0 CABLES

ORDER NUMBER	DESCRIPTION	UNIT
1 57563	6' cable	EA
2 57564	6' extension: series A female to series A male	EA



E EXPONENT® USB 2.0 CABLES

ORDER NUMBER	DESCRIPTION	UNIT
1 57467	6' extension: series A female to series A male	EA
2 57545	6' cable	EA
3 57546	10' cable	EA
4 57547	15' cable	EA

NEW!

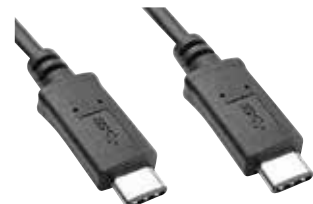

F EXPONENT® USB-C 3.1 CABLE

Can be used with mobile devices, laptops and tables supporting Type-C port connections and power output. First Generation USB-C Cable supports USB 3.0 (5Gbps) SuperSpeed Data Transfer. Male to Male. 3' long cable. Black.

ORDER NUMBER	DESCRIPTION	UNIT
57565	3' cable	EA

Computer Accessories – cables and adaptors



A STARTECH HDMI CABLE ADAPTORS

Cable adaptors for HDMI connectors for capable devices. Black.

ORDER NUMBER	DESCRIPTION	UNIT
HDMI TO DVI-D VIDEO CABLE - MALE TO DVI FEMALE		
Aluminum-mylar foil with braided shielding.		
1	HDDVIMF8IN 8' length, Lifetime warranty	EA
HDMI TO DVI-D CABLE - MALE TO MALE		
High performance cable designed to provide the best quality picture available.		
2	HDMIDVIMM6 6' length, Lifetime warranty	EA
HDMI TO VGA ADAPTOR		
Supports resolutions up to 1080p (1920×1080).		
3	HD2VGAE2 9.6" length, Lifetime warranty	EA
HDMI TO VGA ADAPTOR WITH AUDIO		
Supports resolutions up to 1080p (1920×1080).		
4	HD2VGAA2 9.8" length, 2-year warranty	EA



C STARTECH DVI LINK CABLES

Provides a high-speed, crystal-clear connection to your DVI digital devices. Lifetime warranty. Black. 6' length.

ORDER NUMBER	DESCRIPTION	UNIT
1	DVIMM6 Single link, supports resolution up to 1920×1200	EA
2	DVIDDMM6 Dual link, supports resolution up to 2560×1600	EA

D STARTECH USB 3.0 ADAPTOR

Add Gigabit Ethernet network connectivity to a Laptop or Desktop through a USB 3.0 port. USB 3.0 network adaptor is backward compatible with older USB 2.0/1.x computer systems (speed limited by USB bus). Powered directly from the USB ports. 2-year warranty.

ORDER NUMBER	DESCRIPTION	UNIT
USB31000S	2.6' length, Black	EA



B STARTECH USB-C ADAPTORS

Connect MacBook, Chromebook or laptop with USB-C to other devices. Black.

ORDER NUMBER	DESCRIPTION	UNIT
USB-C TO HDMI ADAPTOR		
Deliver the quality of Ultra HD to your 4K display. Compatible with Thunderbolt™ 3 ports.		
1	CDP2HD 5.4" length, 2-year warranty	EA
USB-C TO VGA ADAPTER		
Supports resolutions up to 1080p (1920×1080). Compatible with Thunderbolt™ 3 ports.		
2	CDP2VGA 7" length, 2-year warranty	EA
USB-C TO DVI ADAPTER		
Enables DVI video output from USB Type-C port on laptop, tablet, or smartphone. Equipped with extra-long 12"(30cm) attached cable. Achieve video resolutions up to 4K 30Hz with backward compatibility support for 1920×1200.		
3	CDP2DVIEC 3' (1m) length, Lifetime warranty	EA
USB-C TO USB-A USB 2.0 CABLE - MALE TO MALE		
With data transfer speeds of 480 Mbps. Compatible with Thunderbolt™ 3 ports.		
4	USB2AC1M 3' (1m) length, Lifetime warranty	EA
5	USB2AC2M 6' (2m) length, 2-year warranty	EA
USB-A TO USB-C CABLE		
USB 3.1 cable transfers data faster; supports 10Gbps data transfer speeds.		
6	USB31AC1M 3' (1m) length, 2-year warranty	EA
USB-C TO DISPLAYPORT ADAPTOR		
Connect your DP over USB Type-C computer directly to a monitor.		
7	CDP2DPMM6B 6' length, 2-year warranty	EA
USB-C TO USB-A ADAPTOR		
Connect your USB Type-C laptop to a USB legacy peripheral device. Compatible with Thunderbolt™ 3 ports.		
8	USB31CAADP 6' length, 2-year warranty	EA
USB-C TO USB-B CABLE		
Connect peripheral devices, such as a printer, external drive or docking station to USB Type-C™ laptop or tablet. Compatible with Thunderbolt™ 3 ports.		
9	USB315CB2M 6' length, 2-year warranty	EA

NEW!



NEW!



E STARTECH USB TO VGA MULTI MONITOR ADAPTOR

Multi-monitor external video adaptor lets you add a high-resolution (1920x1200) external VGA output to your desktop or laptop computer, using an available USB 2.0 port.

ORDER NUMBER	DESCRIPTION	UNIT
USB2VGAE3	3' cable, Black	EA

A IOGEAR 4-PORT USB 2.0 HUB

Compact and lightweight, featuring Plug-n-Play. Tuck-away USB cable makes the hub easy to carry and convenient to store. USB 2.0 connectivity. High-speed data transfer rate.



ORDER NUMBER	UNIT
GUH285W6	EA

C KENSINGTON® USB 3.0 HUB

The UH4000 USB 3.0 4-Port Hub ensures you can connect all your peripheral desktop accessories. Leveraging USB 3.0 technology, each of the four ports can support lightning fast transfer speeds so you can work more efficiently.



ORDER NUMBER	UNIT
K39121WW	EA

E KENSINGTON® UH1400P 8-IN-1 DRIVERLESS MOBILE HUB

Universally compatible portable hub is an ideal plug and play solution. Ultra HD (Single 4K @ 60Hz) extends visual productivity with high resolution, contrast and colour depth. Supports up to 85W power pass-through, so you can use your USB-C power supply to quickly and easily charge any USB-C enabled laptop.



ORDER NUMBER	UNIT
K33820WW	EA

G KENSINGTON® INTERNATIONAL TRAVEL ADAPTER -GROUNDED

Engineered to safely power your devices in more than 200 countries around the world. Higher Power Output safely supplies up to 1575W to the most popular travelling device companions, including laptops, smartphones, shavers and hair dryers. Includes a retractable 3-pole adapter to power laptops and other devices, and provides an internal fuse to protect connected devices from unexpected power surges. Dual 2.4A USB Ports provide the fastest charging available for two devices. 2-year limited warranty.



ORDER NUMBER	UNIT
K38238WW	EA

B STARTECH 3.0 USB-A AND USB-C HUB

Add four USB 3.0 (5Gbps) ports to your laptop, including three USB Type-A charge-and-sync ports, and one USB Type-C port USB 3.0. Portable/Desktop USB hub supports USB Bus or Self Powered (power adapter incl); attached 5.7" (14.6cm) USB-A cable. Charge up to 2.4A (12W) on any port up to 20W maximum shared between all connected devices using included external 5V 4A universal power adapter. USB 3.0 SuperSpeed 5Gbps (USB 3.1 Gen 1 / USB 3.2 Gen 1) shared with all downstream devices; supports thumb drives, data storage devices, keyboards, mice, web cams, headsets.



ORDER NUMBER	UNIT
HB30A3A1CSFS	EA

D STARTECH 4-PORT SUPERSPEED HUB

Instantly add 4 USB 3.0 ports to your laptop or computer. USB 3.0. Backward compatible with USB 2.0 and 1.x devices.



ORDER NUMBER	UNIT
ST4300USB3	EA

NEW!

F MANHATTAN QI WIRELESS CHARGING PAD

Qi™-certified to ensure a safe charge for you and your devices. Fast-charging of compatible smartphones and wireless-charging phone cases. Built-in safety technology that shuts off power output when metal is detected to prevent interference or device damage. 10W.



ORDER NUMBER	UNIT
102186	EA

NEW!

H STARTECH DUAL-PORT USB CHARGER - INTERNATIONAL TRAVEL ADAPTER

This versatile travel charger ships with interchangeable power plugs that let you plug in and charge your devices nearly anywhere you go around the world. Plus, you can charge two of your devices at the same time. This dual-port USB wall charger lets you charge two mobile devices at once, using a single USB wall charger. Features 2.4A USB 2.0 port and 1A USB 2.0 port.



ORDER NUMBER	UNIT
USB2PACBK	EA



NEW!

A KENSINGTON® SD1650P USB-C SINGLE 4K PORTABLE DOCKING STATION

The perfect compact mobile dock with 100W Power Pass-Through. Universal compatibility, plug and play installation, single 4K (HDMI @ 30Hz) or 1080p (VGA Full HD @ 60Hz) video and six ports for productivity including 5Gbps speeds via 2 USB-A 3.2 Gen1 ports, 1 USB-C 3.2 Gen1 port, and 1Gbps Ethernet port. 3-year limited warranty.

ORDER NUMBER	UNIT
K34020WW	EA



B STARTECH USB LAPTOP DOCKING STATIONS

Transform your laptop into a mobile workstation. Travel docking station - HDMI or VGA - USB 3.0. HDMI® or VGA video output, USB 3.0 hub port, and GbE. 3-year warranty. Black.

ORDER NUMBER	DESCRIPTION	UNIT
USB35MDOCKHV	3' cable, Black	EA



NEW!

C KENSINGTON® USB-C TRIPLE VIDEO DOCKING STATION

Nine-in-one design features plenty of ports for all connectivity needs, while a zero-footprint mounting option and security cable lock slots let you maximize desktop space, reduce clutter, and protect your investment. 85W power delivery, data transfer speeds up to 10Gbps, driverless USB-C connectivity, free Kensington DockWorks™ software. Front Panel: 1 x Power Button, 1 x USB-C 3.2 Gen2, 3 x USB-A 3.2 Gen2, 1 x Audio Combo Jack. Side Panel: 1 x USB-C Host Port. Back Panel: 1 x HDMI 2.0, 2 x DP1.4++, 1 x 1Gbps Ethernet, 1 x DC Jack. Windows 10 or later. 3-year limited warranty. Black.

ORDER NUMBER	UNIT
K33480NA	EA



NEW!

D KENSINGTON® USB-C & USB 3.0 DUAL 4K HYBRID DOCKING STATION

Ultimate hybrid docking solution for Ultra High Definition Dual 4K @ 60Hz video. Features include the ability to select between HDMI 2.0 and DP++ 1.2, with four video ports in all; six USB ports; 100W power delivery; a 1m (3.28') USB-C to USB-C cable with USB 3.0 adapter; Thunderbolt 3 compatibility; optional Kensington DockWorks™ software. 2 x HDMI v2.0 and 2 x DisplayPort 1.2++. Windows 7 or above, macOS 10.14 or above, Chrome OS 44 or above. 3-year warranty. Black.

ORDER NUMBER	UNIT
K33620NA	EA



NEW!

E KENSINGTON® SD4840P TRIPLE VIDEO DRIVERLESS DOCKING STATION

Plug and play installation without the need for drivers or downloads. Two Display++ 1.4, One HDMI 2.0. USB-C Alt Mode.

ORDER NUMBER	UNIT
K33806NA	EA



NEW!

F KENSINGTON® SD5700T THUNDERBOLT™ 4 DUAL 4K DOCKING STATION WITH 90W PD

The first of a generation, this docking station is compatible with Thunderbolt 4 laptops. Supports USB-C and USB 4.0 accessories and provides full power delivery, regardless of how many devices are connected. 3-year warranty. Features include 11-ports, Single 8K @ 30 Hz, or up to Dual 4K @ 60Hz video, 40Gbps data transfer speeds, UHS-II SD 4.0 card reader speeds. Supports USB-C PD 3.0 (90W of laptop charging).

ORDER NUMBER	UNIT
K35175NA	EA



A D-LINK® EXO SMART AX1500 WI-FI 6 ROUTER

Wi-Fi 6 technology provides faster speeds, greater capacity and less network congestion. Speeds up to 1.5 Gbps (1200 Mbps on 5 GHz band and 300 Mbps on 2.4 GHz band). 4 Gigabit Ethernet LAN ports and 1 Gigabit Ethernet WAN ports provide optional wired connectivity. Voice control for an even easier home Wi-Fi networking experience.

ORDER NUMBER	UNIT
DIR-X1560	EA



NEW!

B TP-LINK® 300MBPS WIRELESS N ROUTER

Combined wired/wireless network connection device designed specifically for small business and home office networking requirements. The exceptional and advanced wireless performance make it ideal for streaming HD video, making VoIP and online gaming. Also, WPS button on the sleek and fashionable exterior ensures WPA2 encryptions, preventing the network from outside intrusions.

ORDER NUMBER	UNIT
TL-WR841N	EA

NEW!



C D-LINK® AX3200 MESH WI-FI 6 ROUTER

High-gain antennas and power amplifier for greater Wi-Fi coverage. Intelligent QoS engine for traffic optimization. 800 Mbps and 2402 Mbps speeds. 4 Gigabit Ethernet LAN ports and 1 Gigabit Ethernet WAN port. Voice control for an even easier home Wi-Fi networking experience and enhanced parental controls.

ORDER NUMBER	UNIT
DIR-X3260	EA



D TP-LINK® AC1200 WIRELESS DUAL BAND ROUTER

Enjoy connections 3x faster than Wireless N with Wireless AC technology. 300Mbps over the 2.4GHz and 867Mbps over the crystal clear 5GHz band. 4 external antennas provide stable wireless connections and optimal coverage, Supports IGMP Proxy/Snooping, Bridge and Tag VLAN to optimize IPTV streaming. WEP, WPA/WPA2-Enterprise (802.1x).

ORDER NUMBER	UNIT
ARCHER C50 V3	EA



E D-LINK® ETHERNET DESKTOP SWITCH

Auto-sensing ports, allowing a small workgroup to flexibly connect to Ethernet and Fast Ethernet devices to create an integrated network. Plug 'n' play installation. 100 Mbps half duplex, 200 Mbps full duplex. Limited lifetime warranty.

ORDER NUMBER	DESCRIPTION	UNIT
DES-1005E	5 ports	EA



F D-LINK® GIGABIT DESKTOP GREEN SWITCHES

Green technology saves energy while reducing heat output, providing a longer product life without sacrificing operational performance. Automatically powers down ports that have no link activity and can also detect connected cable lengths to adjust power usage accordingly. Plug 'n' play installation. 1 Gbps. Limited lifetime warranty.

ORDER NUMBER	DESCRIPTION	UNIT
1 DGS-1005G	5T-ports	EA
2 DGS-1008G	8T-ports	EA
3 DGS-1016A	16 ports	EA



A D-LINK® AC1300 WI-FI NANO USB ADAPTER

Connect to high-speed wireless networks with this Nano USB giving you a faster, more reliable wireless connection 867 Mbps (5 GHz) or 400 Mbps (2.4 GHz).

ORDER NUMBER	UNIT
DWA-181	EA

B TP-LINK® AC 600 NANO WIRELESS USB ADAPTER

High-Speed Dual Band Adapter for Better Connections. 200Mbps on 2.4GHz and 433 Mbps on 5GHz. Nano design. Dual Band Wireless, upgrades devices to work with the latest dual-band WiFi router for faster speed and extended range. Supports Windows 10/8.1/8/7/XP, Mac OS X. Supports 64/128-bit WEP, WPA/WPA2, and WPA-PSK/WPA2-PSK encryption standards.



ORDER NUMBER	UNIT
ARCHER T2U NANO	EA



C TP-LINK® WIRELESS N NANO USB ADAPTER

Connect a desktop or notebook computer to a wireless network. 150Mbps. Sleek miniature design. Speedy wireless transmission. Connect in no time with easy setup utility in 14 languages. Supports 64/128 WEP, WPA/WPA2, WPA-PSK/WPA2-PSK.



ORDER NUMBER	UNIT
TL-WN725N	EA

D D-LINK® WIRELESS AC1200 DUAL BAND USB ADAPTOR

Seamless gaming, smooth HD video streaming and fast file transfers. Up to 300 Mbps (2.4 GHz) or 867 Mbps (5 GHz) to deliver fast wireless speeds and less interference for maximum throughput. USB 3.0. Backward compatible.



ORDER NUMBER	UNIT
DWA-182	EA

E D-LINK® AC750 PLUS WI-FI RANGE EXTENDER

Extend your home wireless coverage and enjoy wireless connection speeds of up to 750 Mbps with the latest wireless AC technology. Simple and easy to use. Simply plug it into a power outlet anywhere in your home to instantly extend a wireless network, without worrying about compatibility with older devices.



ORDER NUMBER	UNIT
DAP-1530	EA

F D-LINK® AV2 POWERLINE NETWORK EXTENDER KIT

Make it easy to create a high-speed HomePlug network. Plug into any available power outlet and press the connect button to create a secure connection. Includes 2 adapters. 1,000 Mbps.



ORDER NUMBER	UNIT
DHP-601AV	EA

G TP-LINK® AC750 MESH WI-FI RANGE EXTENDER

Boost WiFi coverage up to 1,500 sq.ft. and connect up to 20 devices. Compatible with WiFi Router, Gateway, Access Point (2.4GHz - 300Mbps / 5GHz - 433Mbps). Enjoy lag-free connection to any type of devices, including wired devices via Fast Ethernet Port. The 10/100M Ethernet port can easily turn your wired Internet connection into a wireless access point. Easily set up and manage your WiFi in a few quick and easy steps.



ORDER NUMBER	UNIT
RE215	EA



H TP-LINK® UNIVERSAL WI-FI RANGE EXTENDER

Range Extender mode boosts wireless signal to previously unreachable or hard-to-wire areas flawlessly. Easily expand wireless coverage at a push of Range Extender button. Miniature size and wall-mounted design make it easy to deploy and move flexibly. Ethernet port allows the Extender to function as a wireless adaptor to connect wired devices. Tether App allows easy access and management using any mobile device. LED Control function includes a Night Mode for peaceful sleep. 300 Mbps. WPA/WPA2 WEP.



ORDER NUMBER	UNIT
TL-WA850RE	EA

I D-LINK® N300 WIRELESS RANGE EXTENDER

Extends the range of your WiFi network to hard to reach areas inside or around your home. Smart signal indicator helps you find the ideal placement location. Includes a fast ethernet port. 300 Mbps.



ORDER NUMBER	UNIT
DAP-1325	EA

A ADESSO® CYBERTRACK H4 HD WEBCAM WITH MANUAL FOCUS

Record and share colourful HD quality video with fine detail. Wide-angle microphone that lets your voice be heard loud and clear. Instant messenger compatibility, so you can enjoy video conferencing with today's most popular Instant Messenger applications. Manual focus and built-in microphone. 1080P resolution. 2.1 Mega pixel CMOS sensor. Compatible with Windows® 10, 8, 7, Vista, MAC OS X 10.6 and Android.



ORDER NUMBER	UNIT
CYBERTRACK H4	EA

C ADESSO® CYBERTRACK H3 HD WEBCAM

Record and share colourful HD quality video with fine detail. Wide-angle microphone that lets your voice be heard loud and clear. Instant messenger compatibility, so you can enjoy video conferencing with today's most popular Instant Messenger applications. Manual focus and built-in microphone. 720P resolution. 1.3 Mega pixel CMOS sensor. Compatible with Windows® 10, 8, 7, Vista, MAC OS X 10.6 and Android.



ORDER NUMBER	UNIT
CYBERTRACK H3	EA

E ADESSO® CYBERTRACK H2 HD WEBCAM

Record and share colourful VGA quality videos with an integrated microphone that lets your voice be heard loud and clear. 480P video resolution, 300K pixel CMOS sensor, USB 2.0 interface and Fixed Focus. 640 x 480. Compatible with popular web conferencing applications like Zoom, Skype, Webex, Goto Meeting and more.



ORDER NUMBER	UNIT
CYBERTRACK H2	EA

G LOGITECH® C270 HD WEBCAM

Fluid Crystal™ Technology makes for a smoother video, sharper picture, richer colours and clearer sound in real-world conditions. Features pan, tilt and zoom controls. Video and photo capture, face tracking and motion detection. Built-in mic with noise reduction. 1280x720 dpi HD resolution. 2-year warranty.



ORDER NUMBER	UNIT
960-000694	EA

B LOGITECH® C505 HD WEBCAM

Step up from built-in laptop optics with a webcam that delivers crisp, smooth and colourful video quality with widescreen. Features single, omnidirectional long-range mic with noise-reduction to support clear, natural conversation up to 3 metres away. Extra-long 2m USB-A cable, 60° diagonal field of view. HD 720p/30 fps. Works with popular calling platforms, Windows® 10 or later, Windows 7 or later, macOS 10.10 or later, Chrome OS™. USB - A port.



ORDER NUMBER	UNIT
960-001363	EA

D LOGITECH® C930E WEBCAM

Provides the widest-ever business webcam field-of-view at 90 degrees. HD 1080p H.264/ SVC UVC 1.5 encoding. Features Carl Zeiss® glass lens, privacy shutter, plug-and-play USB connectivity, 4X digital zoom and multiple mounting options. 3-year warranty.



ORDER NUMBER	UNIT
960-000971	EA

F SPY GUARD WEBCAM COVERS

Slim size allows most laptops to close completely. Sliding closure easily opens & closes to prevent scratches. Assorted colours.



ORDER NUMBER	UNIT
AWH012BT	3/PK

H LOGITECH® C920S PRO HD WEBCAM

Look your best on video calls and record polished videos with full HD video (1080p at 30fps) and clear stereo sound with all the most popular video apps. Built-in HD autofocus and light correction. Tripod-ready universal clip fits laptops, LCD or monitors. Includes 1.5 m cable. 1080p/30fps - 720p/30fps. Compatible with Windows® 10 or later, Windows 8, Windows 7. Two integrated mics capture audio from every angle. 2-Year Limited Hardware Warranty.



ORDER NUMBER	UNIT
960-001257	EA

Computer Accessories – webcams

NEW!

A MICROSOFT® LIFECAM CINEMA™ HD WIDESCREEN WEBCAM

Deliver clear, quality videos without leaving anyone out of the shot. Automatically controls exposure for bright and colour video. 360-degree rotation. USB 2.0 interface. 5 Megapixels. 1280×720. 30 fps. 3-year limited warranty.



ORDER NUMBER	UNIT
H5D-00018	EA

B LOGITECH® STREAMCAM PLUS WEBCAM

Stunning video content with smooth motion to every aspect of your online world. From recording videos to streaming and beyond. Smart auto-focus makes it easy to get professional-quality results. Auto-framing and intelligent exposure ensure you always look your best in any lighting. USB 3.1 interface. 1080p/60 fps in MJPEG. Compatible with Windows® 10 and MAC 10.14. 1-year limited warranty.



ORDER NUMBER	UNIT
960-001280	EA

NEW!

C MICROSOFT® LIFECAM STUDIO FOR BUSINESS

Experience the clarity and detail of HD video with brilliant colour and crystal-clear audio. 1280×720 dpi resolution. Compatible with Windows® 7, Windows® Vista and Windows® XP with Service Pack 2 or higher. Features 1.5 GB free hard-disk space, 1080p HD sensor, TrueColor Technology with face tracking, Skype certification and wideband microphone. 3-year limited hardware warranty.



ORDER NUMBER	UNIT
5WH-00002	EA

NEW!

D LOGITECH® LITRA GLOW STREAMING LIGHT

Premium streaming light is the fastest way to achieve professional-quality lighting for videos and streaming. Logitech's TrueSoft™ technology delivers balanced, full-spectrum LED light with cinematic colour accuracy for natural skin tones and a radiant look on camera. Eliminate harsh shadows with wide, soft light that flatters using an innovative frameless diffuser. Three-way monitor mount and adjustable brightness and colour temperature controls. Includes monitor mount and USB-C to USB-A cable. 12"W×4 15/16"D×2"H.



ORDER NUMBER	UNIT
946-000001	EA

NEW!

E JABRA® PANACAST VIDEO CAMERA

Panoramic, 4K video using 13-megapixel camera and patented real-time video stitching. 180° coverage. Intuitive camera technology detects individual participants and optimizes the field of view to include everyone in the conversation. Automatically and continuously optimized under varying lighting conditions to provide a better viewing experience. Whiteboard sharing feature lets you share content from up to three whiteboards digitally. Advanced algorithms capture your whiteboard content in real time from any position in the room, displaying it clearly within your meeting for everyone to see. 1-year limited warranty.



ORDER NUMBER	UNIT
8100-119	EA

NEW!

F KENSINGTON® L1000 USB BICOLOUR RING LIGHT WITH WEBCAM MOUNT

Affordable, feature-rich lighting solution for quickly improving the look on video conference calls. 96 bicolour LEDs with 120° beam angle, frosted lens, and a max brightness of 960 lumens perfectly augments the lighting in most office environments. Features flexible positioning, adjustable colour temperature, push button controls. USB-A Powered (5V/2.0A). 2-year warranty. Black/White.



ORDER NUMBER	UNIT
K87653WW	EA

NEW!

G JABRA® PANACAST 50 VIDEO CAMERA

Engineered to be the first new-normal-ready intelligent video bar. 180° field of view keeps everyone in the picture at a safe distance. Virtual director intelligently adjusts the video in real time for more immersive meetings. Real-time whiteboard streaming for a more inclusive remote collaboration. 2-year limited warranty. Black.



ORDER NUMBER	UNIT
8200-232	EA

NEW!

H KENSINGTON® ACCESSORY MOUNTS

Versatile mounting solutions for microphones, webcams, and lighting systems. Desktop Mount: 7" non-skid base, height adjustment from 12 1/2" to 19 1/3", and cable management clip. Arm boom: horizontal (32 1/2") and vertical extensions (37 3/8"). Attaches to desks up to 2 3/8" thick.



ORDER NUMBER	DESCRIPTION	UNIT
1 K87651WW	Desktop Mount	EA
2 K87652WW	Arm Boom	EA



A LOGITECH Z207 STEREO SPEAKERS WITH BLUETOOTH

Listen wirelessly from Bluetooth devices, such as your smartphone or tablet, and/or connect one device, such as your computer with a wired connection, seamlessly switching between the two to watch videos and listen to music. 3.5 mm plug. 10 Watt. 9.5"×3.5"×4.9".

ORDER NUMBER	UNIT
980-001294	PR



B ULTIMATE EARS BOOM 3 WIRELESS SPEAKER

Super-portable waterproof, dustproof wireless speaker built for adventure. Wrapped in stunning, high performance fabric that shimmers. Pair over 150 speakers together. Features loud and true spatial 360-degree sound with deep and accurate bass, Magic button control, 15-hour rechargeable battery life, and maximum sound level 90 db. Bluetooth. Operational range up to 150 ft. Limited 2-year hardware warranty. Black.

ORDER NUMBER	UNIT
984-001348	ST

C LOGITECH® S120 MULTIMEDIA SPEAKERS

Clear stereo sound in a slim design. Easy setup via any 3.5mm input and access to all controls on the right speaker. 2.2 watts. 2.7"W×2.5"D×6.2"H.



ORDER NUMBER	UNIT
980-000012	PR



D VERBATIM™ WIRELESS CUBE BLUETOOTH® SPEAKER

Featuring TWS Stereo Sound, this speaker can pair with a second speaker to provide even more sound. Designed for more than just music, it features a built-in microphone for hands-free calling at the touch of a button. Equipped with a rechargeable battery, providing up to 5 hours of continuous playtime on a single charge. 5 Watts.



ORDER NUMBER	UNIT
70224	EA



E VERBATIM™ WIRELESS MINI BLUETOOTH® SPEAKER

Featuring TWS Stereo Sound, this speaker can also be paired with a second speaker to provide even more sound. Designed for more than just music, it features a built-in microphone for hands-free calling at the touch of a button. Equipped with a rechargeable battery for up to 4 hours of continuous playtime on a single charge. 3 Watts.



ORDER NUMBER	UNIT
70228	EA

F MAXELL® NOISE CANCELLATION HEADPHONES

190400 headphones eliminate up to 95% of sounds that interfere with your listening pleasure. These lightweight headphones fit comfortably over your ears and are collapsible for storage. With single entry cord and include a travel pouch.



ORDER NUMBER	DESCRIPTION	UNIT
190400	HP/NC-II	EA

G MAXELL® HP-200 LIGHTWEIGHT STEREO HEADPHONES

Stereo headphones ideal for portable MP3/iPod players. Adjustable, locking headband. Silver.



ORDER NUMBER	UNIT
190318	EA



H KENSINGTON® USB-C HI-FI HEADPHONES

Designed with sound clarity and device compatibility in mind, these high-quality, cost-effective USB-C headphones are perfect for e-learning, working from home, educational and office environments, and more. Compatible with all USB-C devices running Windows, macOS, iOS, Android, and Chrome OS.



ORDER NUMBER	UNIT
K97456WW	EA

Computer Accessories – ear buds and headsets



A MAXELL BASS 13 WIRELESS EARBUDS WITH MIC

Increased heavy bass response, with finely tuned crystal clear highs, mids, and vocals for the ultimate sound experience. Rubberized earbuds, inline MIC to take/make calls with volume control. Bluetooth. 3 hours play/talk time.

ORDER NUMBER	DESCRIPTION	UNIT
1 199745	Black	EA
2 199746	White	EA



B MAXELL® JELLEEZ WIRELESS EAR BUDS WITH MIC

Soft rubberized on ear design for extended wear comfort fit. Noise isolating earbuds with built in microphone. Bluetooth. Micro-USB charging cable. 8 hours playtime.

ORDER NUMBER	DESCRIPTION	UNIT
1 198018	Black	EA
2 198019	White	EA



C MAXELL® JELLEEZ TRUE WIRELESS EARBUDS WITH MIC

Built-in microphone. Bluetooth 5.0. Charging case with up to 6 hours of additional battery life. 2 hours playtime.

ORDER NUMBER	DESCRIPTION	UNIT
1 199460	Black	EA
2 199461	White	EA



D MAXELL® IN-EAR BUDS WITH MICROPHONE AND REMOTE

Ear buds with microphone and remote for mobile phones. In-ear design; includes soft silicone eartips in three sizes.

ORDER NUMBER	DESCRIPTION	UNIT
1 190300	Black	EA
2 190303	White	EA



E MAXELL® JELLEEZ STEREO EAR BUDS WITH MIC

Lightweight, soft comfort fit. Ideal for all portable CD/DVD/Mp3/iPod players. Soft touch rubber colour matching cord and plug. 3.5 mm plug.

ORDER NUMBER	DESCRIPTION	UNIT
1 191569	Black	EA
2 199728	White	EA



F MAXELL EARBUD HEADSET WITH DETACHABLE BOOM MIC

Use for conference calls or listening to music. Perfect for educational market, call centres and telework. Adjustable boom mic for perfect positioning. Double flanged ear tips for noise isolation. 6 hours playtime. 3.5 mm plug.

ORDER NUMBER	DESCRIPTION	UNIT
199616	Black	EA



G KENSINGTON® USB-CHI-FI HEADPHONES

Powerful 40mm drivers for deep bass and wider dynamic range deliver exceptional sound. Limits sound to 94db for safe listening. Noise-cancelling microphone, adjustable, padded headband, soft leatherette wrapped foam earpads. Black.

ORDER NUMBER	UNIT
K97457WW	EA



H MAXELL KIDSSAFE HEADPHONES

Lightweight and small design for kids with colourful interchangeable ear caps. Features wired microphone and Stereo sound output.

ORDER NUMBER	UNIT
190338	EA



I KENSINGTON® CLASSIC USB-A HEADSET

Designed with sound clarity and device compatibility in mind, this USB-A headset offers a high-quality, cost-effective solution that is perfect for e-learning, working from home, educational and office environments and more. Compatible with all USB-A devices running Windows, macOS, iPadOS, Android and Chrome OS.

ORDER NUMBER	UNIT
K97601WW	EA

Computer Accessories – headsets



**A MAXELL®
BASS 13 BLUETOOTH
HEADPHONES WITH MIC**

Sound performance with 40mm drivers increases heavy bass response with finely tuned crystal clear highs, mids, and vocals for ultimate sound experience Noise isolating ear pads, built-in microphone for hands free calling. Bluetooth. 8 hours play/talk time. Black.

ORDER NUMBER	UNIT
199793	EA



NEW!



**B MAXELL®
WIRELESS HEADPHONES
WITH BOOM MIC**

4-in-1 Bluetooth headphones. Supports MicroSD card, FM radio. Adjustable padded headband. Noise isolating boom mic. Bluetooth. 12 hours play/talk time. 6ft 3.5mm cable. Black.

ORDER NUMBER	UNIT
199342	EA



**C LOGITECH®
H340 USB VHEADSET**

For clear internet calls and stereo sound in seconds. Connect this comfortable headset to your USB port to enjoy your calls, music, movies and videos in crystal-clear digital sound. Windows® and Mac® compatible.

ORDER NUMBER	UNIT
981-000507	EA



**D MAXELL® BASS 13
HEADPHONES WITH MIC**

40 mm drivers allow for heavy bass experience. Delivers an immersive full range sound. Soft cushion ear pads with noise isolation to block out unwanted sound. Built-in microphone for hands free calling. Wired 3.5mm plug Black.

ORDER NUMBER	UNIT
199840	EA



**E MAXELL® STEREO
USB HEADPHONES
WITH BOOM MIC**

Ideal for testing and language tests, Perfect for education market, call centres, work at home. Features Boom mic with volume control, 6ft cord. USB connection. Black.

ORDER NUMBER	UNIT
199323	EA



**F LOGITECH®
COMFORT H390 USB HEADSET
WITH MICROPHONE**

Binaural headset has a noise-cancelling microphone that reduces background noise. In-line control for volume and mute. USB connectivity.

ORDER NUMBER	UNIT
981-000014	EA



**G LOGITECH® H111
STEREO HEADSET**

Enjoy clear audio for music, games and calls. 3.5 mm plug. Flexible boom can rotate 180° and be worn left or right or tucked out of the way when not in use. 1-year limited hardware warranty.

ORDER NUMBER	UNIT
981-000612	EA



**H LOGITECH® ZONE WIRED
HEADSET**

Microsoft® Teams Open Office-certified. Delivers premium audio and reliable call clarity with advanced noise-cancelling mic technology. Lightweight, stylish and super comfortable to wear all day. Suppress distracting sounds as close as 60 cm away. USB-C connection plus a USB-A adaptor (included). 2-year warranty.

ORDER NUMBER	UNIT
981-000871	EA



**I LOGITECH®
H540
USB HEADSET**

Premium digital audio performance and comfort. Simply plug the USB cord into your desktop or laptop computer to instantly immerse yourself in pure, rich, digital sound. Windows® and Mac® compatible.

ORDER NUMBER	UNIT
981-000510	EA

Telephones and Accessories



A PLANTRONICS® VOYAGEUR 5200 BLUETOOTH HEADSET

Enjoy clear conversations anywhere with Plantronics unique WindSmart® technology. Four-mic noise cancelling and six layers of our unique WindSmart technology ensure your voice comes through clearly. HD Voice clarity on wideband devices and networks. Smart sensor technology. Up to 7 hours of talk time and 9 days standby. Up to 98 ft. Streams music, driving directions, podcasts and more. Bluetooth and RJ9 connector.

ORDER NUMBER	UNIT
212722-01	EA



B PLANTRONICS® CS540 CONVERTIBLE WIRELESS HEADSET SYSTEM

Lightest DECT™ wireless headset on the market; choice of up to three comfortable, customizable wearing styles. Noise-cancelling microphone, elegant magnetic headset docking. One-touch call answer/end, volume, mute and flash controls at your fingertips; hands-free up to 350 feet. Up to 7 hours of talk time on a single charge.

ORDER NUMBER	DESCRIPTION	UNIT
1 84693-01	Headset	EA
2 60961-34	Headset lifter	EA



C PLANTRONICS® PLANTRONICS® SAVI™ 7210 WIRELESS HEADSET

Will work with 98% of corded desk phones on the market. All day comfort with crystal clear calls DECT™. Range of up to 400'. Flexible noise cancelling microphone boom. RJ9 connector. Up to 12 hours of talk time.

ORDER NUMBER	UNIT
213010-01	EA



D JABRA® PRO 920 WIRELESS HEADSET

Designed for use with most desktop phone systems. Wireless DECT1.9 technology; direct connect to desk phone; noise-cancelling microphone enhances call clarity; up to eight hours talk time. Interchangeable headband or ear hook wearing styles; supports electronic hook switch for remote call answer/end. Mute function directly on the device.

ORDER NUMBER	UNIT
920-65-508-105	EA

E PLANTRONICS® S12 TELEPHONE HEADSET

Ergonomically designed headset system connects to any single or multi-line corded telephone. Noise-cancelling microphone eliminates background noise. Over-the-head design can be worn on either ear. Standard band. Amplifier and headset stand included. RJ9 connector.



ORDER NUMBER	UNIT
65145-04	EA

F JABRA ENGAGE 65 STEREO WIRELESS HEADSET

Engineered for superior wireless connectivity, battery life and crystal-clear calls, Engage 65 is a premium headset for professionals who need first-class customer conversations and connection to up to two devices (desk phone and softphone). Meets Skype for Open Office requirements, and advanced noise cancelling and enhanced speakers give incredible call quality, even in noisy offices.



ORDER NUMBER	UNIT
9559-553-125	EA



A PLANTRONICS® ENCORE PRO NOISE CANCELLING HEADSETS

Soft ear cushions for all-day wearing comfort, metal joints that deliver durability and reliability and a flexible mic with visual and tactile positioning guides for precise positioning and clearer conversations. Requires the Plantronics® Polaris™ cord.

ORDER NUMBER	DESCRIPTION	UNIT
1 89433-01	Monaural HW510	EA
2 89434-01	Binaural HW520	EA
3 66268-03	Polaris™ cord	EA



B PLANTRONICS® VOYAGER 5200 UC BLUETOOTH HEADSET

Be ready to take the call, where you're connected. Multipoint technology allows you to stay connected to two phones at once, and answer calls from either one. Adaptive noise cancelling with WindSmart technology. With one touch, the headset connects to Siri, Google Now or Cortana so you can call phone contacts, send messages, schedule meetings or search the web all via voice. Up to 7 hours of talk time and 9 days standby. Up to 98 ft. Streams music, driving directions, podcasts and more. Includes hard case and charger. Bluetooth and USB connection.

ORDER NUMBER	UNIT
206110-101	EA

C PHILIPS VOICE TRACER DVT2810 AUDIO RECORDER

Automatically transcribe recordings quickly, easily and accurately with Dragon speech recognition software. Features 2 high-fidelity microphones for outstanding audio quality. Stereo MP3 and PCM recording for clear playback and easy file sharing. Speech recognition software with exceptional transcription accuracy rate. Voice activation for hands-free uninterrupted recording. Audio scenes for automatic perfect audio settings in any situation. 2147 hours of recording time. MicroSD memory card slot provides virtually unlimited recording. 8 GB MicroSD Memory. 2" LCD screen. Windows, Mac OS and Linux compatible. Rechargeable li-polymer battery.



ORDER NUMBER	UNIT
DVT2810	EA

D PHILIPS VOICE TRACER DVT4110 DIGITAL RECORDER

Voice-activated recording is convenient for hands-free recording. Great for lectures and interviews. Robust metal design for extra durability. 3 specialized stereo microphones for capturing distant speakers. Stereo MP3 and PCM recording for clear playback and easy file sharing. Free smartphone app for remote audio control and easy sharing of recordings. Tripod mount for optimal stable positioning. Smart recording and playback functions for best recording results. Audio scenes for automatic perfect audio settings in any situation. 2147 hours of recording time. MicroSD memory card slot provides virtually unlimited recording. 8 GB MicroSD Memory. 2" LCD screen. Windows, Mac OS and Linux compatible. Rechargeable li-polymer battery.



ORDER NUMBER	UNIT
DVT4110	EA

NEW!

E LOGITECH® BLUE YETI NANO MICROPHONE

Broadcast-quality sound for podcasting, YouTube videos, streaming and Zoom calls. Combine 24-bit sound with powerful Blue VO!CE vocal effects for professional recording and streaming. 5V 150 mA power consumption. 48 kHz sample rate. 24-bit rate. 2- Blue-proprietary 14 mm condenser capsules. Cardioid and Omnidirectional polar patterns. 20 Hz - 20 kHz frequency response. 4.5 mV/Pa sensitivity. 120 dB (THD: 0.5% 1kHz). Includes stand, USB cable and adaptor. Requires Windows® 10 and higher or MAC® 10.14 or later. 1.39 lbs. 3 7/8" W x 4 1/3" D x 8 1/3" H. Black.



NEW!



F BLACK BOX COILED HANDSET CORD

Standard RJ-22 connectors fit all phones. Black.

ORDER NUMBER	DESCRIPTION	UNIT
1 EJ300-0012	3.6m / 12'	EA
2 EJ300-0025	7.6m / 25'	EA

NEW!



G CABLES TO GO TELEPHONE LINE CORD

These RJ12 cables are constructed of heavy-duty silver satin wiring while gold-plated connectors provide for clear communication. Its 6-wire construction handles multiple phone lines while the heavy duty PVC.

ORDER NUMBER	DESCRIPTION	UNIT
1 09599	14'	EA
2 08133	25'	EA

Telephones and Accessories



A AT&T® DECT 6.0 DIGITAL CORDED/2 CORDLESS HANDSET TELEPHONE SYSTEM

DECT 6.0 technology provides digital security and clear sound quality that won't interfere with wireless networks. Base with corded handset and (2) cordless handsets with charger bases. Featuring digital answering system, call waiting, caller ID with 50 name/number phonebook, backlit display and keypad, base keypad, dual speakerphone, intercom, call transfer, conference call. NEW Call Block Feature. RoHS compliant.

ORDER NUMBER	DESCRIPTION	UNIT
CL84207	Corded base, two cordless handsets	EA



B VTECH® CORDLESS ANSWERING SYSTEM WITH CORDLESS HEADSET

DECT 6.0. Bluetooth® enabled. Connect-to-Cell allows pairing of cell phone to base. Mobile notification. Push-To-Talk intercom. Blue backlit display. Message retrieval and speakerphone from handset. HD audio. 50 name/number CID memory and phonebook (1,000 mobile). 20 plus minutes of record time. Full duplex handset speakerphones. Expandable up to 5 handsets. Black/Silver.

ORDER NUMBER	DESCRIPTION	UNIT
DS6771-3	Cordless dual handset phone	EA



C VTECH® DECT 6.0 DIGITAL CORDLESS PHONES

Featuring DECT 6.0 protocol, call waiting, caller ID with 50 name/number memory, 100 name/number phonebook, green backlit keypad and display, handset speakerphone, intercom, call transfer and conference call functions and volume control. RoHS and Energy Star compliant.

ORDER NUMBER	DESCRIPTION	UNIT
1 CS6919	Cordless handset phone	EA
2 CS6929	With built-in answering machine	EA



D AT&T® TWO-LINE SPEAKER-PHONE WITH CALLER ID

With 2-line operation, call waiting, caller ID with 99-number memory and visual message waiting indicator. Other features include 100-entry directory, 18-number speed dial, navigation buttons with rapid scroll and a switchable data port. Headset compatible (2.5 mm plug). Black.

ORDER NUMBER	DESCRIPTION	UNIT
1 ML17929	2-line Speakerphone	EA
2 ML17939	With built-in answering machine	EA

E AT&T 2-LINE CORDED/CORDLESS ANSWERING SYSTEM WITH CONNECT TO CELL™

Connect to Bluetooth enabled cellular phones to make and receive cellular calls. Mobile phone charging with two built-in USB docks. Mobile notifications: Know when your Android mobile phone receives a text, e-mail or social media update. AT&T Softphone Call Manager merges Microsoft® Linc®, Skype™, VoIP and landline telephone services for flexible, full-access communication on one convenient system. Connect up to two cellular lines and two landlines. Store 6000 directories from up to 4 different cell phones. Digital Answering System – one for each line & caller ID announce.

ORDER NUMBER	DESCRIPTION	UNIT
TL86103	2-line phone system	EA



F VTECH® FOUR-LINE CORDED TELEPHONE CONSOLE

VTECH 4 Line Cordless DECT Office Phone System. The system will expand to support up to 10 devices. Requires CM18455 Base to function. Uses regular Phone line POTs lines. Features a digital answering system, full duplex speakerphone, 180 minutes of record time, customizable music on hold and power back-up. Auto attendant on each line. Caller ID. Extra-large display. 32 number speed dial. DECT 6.0.

ORDER NUMBER	DESCRIPTION	UNIT
1 CM18445	4-line corded console	EA
2 CM18245	Desk phone	EA
3 CM18045	Cordless handset	EA



Business Machines

Projectors & Accessories.	92-93
Shredders & Accessories.	94-100
Calculators.	101-107
Label Makers & Tapes.	108-113
Binding & Laminating.	114-120
Time Clocks.	121-122





A EPSON® POWERLITE E20 3LCD CLASSROOM PROJECTOR

- Create engaging learning environments with this ultra bright, projector
- 3-chip technology for best-in-class colour brightness
- Screen size up to 350" with split screen capability for side-by-side viewing
- 1024 x 768 dpi XGA resolution
- 3,400 brightness (ISO Lumens)
- 6,000-hour lamp life
- Contrast ratio 15000:1
- Aspect ratio 4:3
- HDMI connectivity to get HD quality video and audio with a single cable
- Digital keystone +/-30° vertical
- 5 W speaker
- Weighs 5.95 lbs.
- Includes power cord, VGA cable, remote control and batteries
- 2-year projector, 90-day lamp warranty

ORDER NUMBER	UNIT
V11H981020	EA CHECK ONLINE



B EPSON® POWERLITE W49 3LCD WXGA CLASSROOM PROJECTOR

- Designed to maximize engagement and enrich lesson plans
- Moderator function allows up to 50 users to connect to the display and share content from laptops or mobile devices
- Screen size up to 320" with split screen capability for side-by-side viewing
- 1280 x 800 dpi WXGA resolution
- 3,800 brightness (ISO Lumens)
- 17,000-hour lamp life in ECO mode
- Contrast ratio 16000:1
- Aspect ratio 16:10
- HDMI connectivity to get HD quality video and audio with a single cable
- Digital keystone +/-30° vertical
- 5 W speaker
- Weighs 5.95 lbs.
- Includes power cord, VGA cable, remote control and batteries
- 2-year projector, 90-day lamp warranty

ORDER NUMBER	UNIT
V11H983020	EA CHECK ONLINE



C EPSON® POWERLITE 1288 FULL HD 1080P MEETING ROOM PROJECTOR

- Bringing ultra bright displays to meeting rooms with this wireless portable projector
- Wireless screen mirroring using Miracast®
- Screen size up to 350" with split screen capability for side-by-side viewing
- 1920 x 1800 dpi XGA resolution
- 4,000 brightness (ISO Lumens)
- 5,500-hour lamp life
- Contrast ratio 16000:1
- Aspect ratio 16:9
- HDMI connectivity to get HD quality video and audio with a single cable
- Digital keystone +/-30° vertical
- 16 W speaker
- Weighs 6.83 lbs.
- Includes power cord, VGA cable, remote control and batteries
- 2-year projector, 90-day lamp warranty

ORDER NUMBER	UNIT
V11H978120	EA CHECK ONLINE

NEW!



D VIEWSONIC® PA503S SVGA DATA PROJECTOR

- 800 x 600 dpi WXGA resolution
- 3,800 brightness (ANSI Lumens)
- 15,000-hour lamp life
- Contrast ratio 22000:1
- Aspect ratio 4:3
- HDMI and USB interface
- Digital keystone +/-40° vertical
- Audio: 1 x 2 watt
- Weighs 7.5 lbs.
- Includes power cord, VGA cable and remote control

ORDER NUMBER	UNIT
PA503S	EA CHECK ONLINE



A **QUARTET® PORTABLE TRIPOD PROJECTION SCREEN**

Durable and light-weight. Matte white projection surface with black masking border. Tough steel carrying case.

ORDER NUMBER	DESCRIPTION	UNIT
1 560S	60"×60", Standard	EA
2 570S	70"×70", Standard	EA



D **QUARTET® WALL MOUNT PROJECTION SCREEN**

Durable matte white screen for great image resolution and colour reproduction. Heavy duty springs maintain the screen's original retraction tension. Flat back design.

ORDER NUMBER	DESCRIPTION	UNIT
1 660S	60"×60", Standard	EA
2 670S	70"×70", Standard	EA
3 684S	84"×84", Standard	EA

F **APOLLO® OVERHEAD PROJECTION FILM**

Black image on clear film. For dry toner copiers. Without sensing stripe. 8½"×11".

ORDER NUMBER	UNIT
18575-09222	100/BX

B **KENSINGTON® PRESENTER EXPERT™ WIRELESS WITH RED LASER**

Highlight any area of presentation with a bright red laser at the touch of a button. Intuitive, four-button layout to forward and back slides, hide screen and use the red laser pointer. Internal receiver storage. AES 128-bit encryption. Range up to 150'. 2.4 GHz wireless technology. Pearl White.



ORDER NUMBER	DESCRIPTION	UNIT
K75773WW	Red laser	EA



C **MERANGUE STEALTH LASER POINTER**

Compact design with pocket clip and nylon carry case. Matte finish. 500' range. Uses 2 'AAA' batteries (included).

ORDER NUMBER	DESCRIPTION	UNIT
3891-4011-00-000	Red laser	EA

E **KENSINGTON® JOYSTICK WIRELESS PRESENTER**

Ultra bright green laser pointer for all screen types including plasma and LCD monitors. Backlit buttons and joystick feature help navigate smoothly through presentations.



ORDER NUMBER	DESCRIPTION	UNIT
K72426AMA	Green laser	EA





STACK



SHUT



**WALK
AWAY**

GBC AutoFeed+ SHREDDERS

Don't spend time standing by the shredder.

AutoFeed+ lets you place stacks of paper into the feeder tray, close the lid, and walk away. Your papers will shred automatically while you focus on other tasks. Models range from 60 to 750 sheets and offer either super cross-cut (P4) or micro-cut (P-5) Level Security. **Save time. Secure. Uninterrupted shredding.**



Time Savings is Automatic.



©2022 ACCO Brands. All rights reserved. ACCO® and GBC® are registered trademarks of ACCO Brands. C113_22_P



NEW!

A GBC® PS06-02 STRIP CUT SHREDDER

Single-user model. Dependable shredding in a convenient package with a simple interface and compact design. 9" entry width. Two year machine/two year cutter warranty. Dimensions: 14.29" W×7.87" D×12.72" H.



ACCEPTS:

B SWINGLINE® GS5 PERSONAL STRIP CUT SHREDDER

Single-user model; with 10 litre (2.6 gallon) wastebasket. Auto start, stop and reverse. One year limited warranty. Dimensions: 10.4" W×4" D×13" H.



ACCEPTS:

C SWINGLINE® GX5 PERSONAL CROSS CUT SHREDDER

Single-user model; with 14 litre (3.7 gallon) wastebasket. Auto start, stop and reverse. One year limited warranty. Dimensions: 11.6" W×5.5" D×13.9" H.



SAFETY LOCK

ACCEPTS:

D FELLOWES® POWERSHRED® 6C CROSS CUT SHREDDER

Single-user model; 6 sheet cross cut with safety lock and quiet operation. One year machine/three year cutter warranty. Dimensions: 11.75" W×6.625" D×14.375" H.



SAFETY LOCK

ACCEPTS:

E FELLOWES® POWERSHRED® LX45 CROSS CUT SHREDDER

Single-user model; 8 sheet cross cut with safety lock and quiet operation. One year machine/three year cutter warranty. Dimensions: 12.2" W×8.7" D×15.8" H.



SAFESENSE TECHNOLOGY

ACCEPTS:

F FELLOWES® POWERSHRED LX65 SHREDDER

Single-user model; patented SafeSense® technology stops shredder when hands touch the paper opening. 12 sheet cross cut. One year machine/five year cutter warranty. Dimensions: 13.4" W×9.7" D×18.5" H.

	ORDER NUMBER	MODEL NUMBER	DUTY CYCLE (MINUTES)	SHRED SIZE AND SECURITY LEVEL	SHEET CAPACITY	WASTEBASKET (GAL / L)	SPEED (FT. / MIN.)	NOISE LEVEL
A	1757402	PS06-02	2 on / 60 off	¼" (P2)	6	2.38 / 9	5.9	72 dB
B	33816-09369	GS5	3 on / 30 off	¼" (P2)	5	2.6 / 9.8	7.4	70 dB
C	33816-09370	GX5	3 on / 30 off	13/64"×1½" (P3)	5	3.7 / 14	8.5	70 dB
D	4771502	6C	3 on / 30 off	5/32"×13/16" (P4)	6	3 / 11.3	10	65 dB
E	4400201	LX45	6 on / 20 off	5/32"×11/32" (P4)	8	4.4 / 16.7	12	70 dB
F	4400301	LX65	6 on / 20 off	5/32"×11/16" (P4)	10	6 / 22.7	13	70 dB

Shredders



ACCEPTS:



A GBC® SHREDMASTER™ PX12-06 SHREDDER

Single-user model; modern interface with user friendly touch controls. Whisper Shred Technology, auto reverse jam prevention and recessed blades to prevent user injury. Two year warranty. Dimensions: 14.37"W×10.04"D×16.06"H.



ACCEPTS:



B FELLOWES® POWERSHRED® LX85 CROSS CUT SHREDDER

Single-user model; patented Safe Sense® technology stops shredder when hands touch the paper opening. One year machine/five year cutter warranty. Dimensions: 13.4"W×9.7"D×18.5"H.



ACCEPTS:



C GBC® EM09-06 MICRO CUT SHREDDER

For 1-2 users; features an auto reverse function, 10 minute run time, overheating indicator and LED status symbols. Shreds paper clips and staples. Separate slot included for CD/DVD shredding. Two year machine/seven year cutter warranty. Dimensions: 16"W×13"D×25"H.



ACCEPTS:



D FELLOWES® AUTOMAX™ 100M SHREDDER

For 1-3 users; features SilentShred™, auto reverse if a jam occurs and energy saving sleep mode shuts the machine down after 2 minutes of inactivity. Two year machine/seven year cutter warranty. Dimensions: 15.38"W×14.56"D×26.38"H.



ACCEPTS:



E FELLOWES® POWERSHRED® LX170 CROSS CUT SHREDDER

Single-user model; 100% Jam Proof System automatically detects and powers through tough jobs for frustration-free shredding. Efficiency Meter indicates the potential for increased sheet capacity in real-time to maximize productivity. Integrated SafeSense Technology stops shredding when hands or paws touch the paper entry. Two year machine/seven year cutter warranty. Dimensions: 14.5"W×10.25"D×20.4"H.



ACCEPTS:



F FELLOWES® POWERSHRED® LX200 MICRO CUT SHREDDER

Single-user model; integrated SafeSense Technology stops shredding when hands or paws touch the paper entry. 100% Jam Proof System automatically detects and powers through tough jobs. Efficiency Meter indicates the potential for increased sheet capacity in real-time to maximize productivity. Two year machine/seven year cutter warranty. Dimensions: 14.5"W×10.25"D×20.4"H.

	ORDER NUMBER	MODEL NUMBER	DUTY CYCLE (MINUTES)	SHRED SIZE AND SECURITY LEVEL	SHEET CAPACITY	WASTEBASKET (GAL / L)	SPEED (FT. / MIN.)	NOISE LEVEL	BAGS ORDER NUMBER
A	1757406	PX12-06	6 on / 60 off	5/32"×1¼" (P3)	12	6 / 22.7	5.9	62 dB	33816-65016
B	4400401	LX85	20 on / 30 off	5/32"×1¼" (P4)	12	5 / 18.9	7	70 dB	77511-36052
C	33816-57397	EM09-06	10 on / 30 off	5/64"×19/32" (P5)	9	6 / 22.7	7.8	58 dB	33816-65016
D	4629001	100M	15 on / 35 off	5/32"×25/64" (P4)	10 (100 auto)	6 / 22.7	8	70 dB	77511-36053
E	5501401	LX170	10 on / 20 off	5/32"×1¾" (P4)	12	5.8 / 22	10	70 dB	77511-36052
F	5015001	LX200	10 on / 15 off	5/32"×½" (P4)	12	6 / 22.7	9	65 dB	77511-36052



ACCEPTS:



A GBC® 60X CROSS CUT AUTOFEED+ SHREDDER

Single-user model; super quiet performance; 60-sheet auto feed operation. Concealed cutters; auto power shut-off; auto cool down with LED indicator. Manual reverse for jam clearance. One year machine/seven year cutter warranty. Dimensions: 15" W×17" D×16" H.



ACCEPTS:



B FELLOWES® LX180 POWERSHRED® CROSS CUT SHREDDER

Single-user model. SafeSense® technology stops shredding when hands touch the paper opening; 100% Jam Proof System eliminates paper jams and powers through tough jobs, energy saving system. SilentShred™ offers ultra-quiet performance for shared workspaces. Efficiency Meter indicates the potential for increased sheet capacity in real-time to maximize productivity. Two year machine/seven year cutter warranty. Dimensions: 14.1" W×11.7" D×21.1" H.



ACCEPTS:



C FELLOWES® LX190 POWERSHRED® CROSS CUT SHREDDER

Single-user model. SafeSense® technology stops shredding when hands touch the paper opening; 100% Jam Proof System eliminates paper jams and powers through tough jobs. Efficiency Meter indicates the potential for increased sheet capacity in real-time to maximize productivity. SilentShred™ offers ultra-quiet performance for shared workspaces. Two year machine/seven year cutter warranty. Dimensions: 16.5" W×11.75" D×23.25" H.



ACCEPTS:



D FELLOWES® LX210 POWERSHRED® MICRO CUT SHREDDER

Single-user model. SafeSense technology stops shredding when hands touch the paper opening. 100% Jam Proof System eliminates paper jams and powers through jobs. Efficiency Meter indicates the potential for increased sheet capacity in real-time to maximize productivity. Two year machine/seven year cutter warranty. Dimensions: 11.7" W×14.13" D×21.1" H.



ACCEPTS:



E FELLOWES® LX220 POWERSHRED® MICRO CUT SHREDDER

Single-user model. SafeSense technology stops shredding when hands touch the paper opening. 100% Jam Proof System eliminates paper jams and powers through jobs. Efficiency Meter indicates the potential for increased sheet capacity in real-time to maximize productivity. Two year machine/seven year cutter warranty. Dimensions: 11.75" W×16.5" D×23.25" H.



ACCEPTS:



F GBC® SHREDMASTER™ SM10-06 MICRO CUT SHREDDER

For one to five users. Jam free technology with continuous sensing. Two year warranty. Dimensions: 14.57" W×11.42" D×19.69" H.

ORDER NUMBER	MODEL NUMBER	DUTY CYCLE (MINUTES)	SHRED SIZE AND SECURITY LEVEL	SHEET CAPACITY	WASTEBASKET (GAL./L)	SPEED (FT./MIN.)	NOISE LEVEL	BAGS ORDER NUMBER	
A	WSM1757601	60X	10 on / 45 off	½" × 1⅜" (P4)	6 (60 auto)	5.25 / 19.9	5.6	55 dB	33816-65016
B	5501601	LX180	20 on / 30 off	½" × 1⅞" (P4)	16	6 / 22.7	10	70 dB	77511-36052
C	5501701	LX190	30 on / 15 off	½" × 1⅞" (P4)	20	8 / 30.3	10	70 dB	77511-36052
D	5015201	LX210	20 on / 15 off	½" × ½" (P4)	16	6 / 22.7	7	65 dB	77511-36052
E	5015401	LX220	30 on / 15 off	½" × ½" (P4)	20	8 / 30.3	7	65 dB	77511-36053
F	1758499F	SM10-06	120 on / 60 off	⅓" × ½" (P5)	10	6 / 22.7	5.9	58 dB	33816-65016

Shredders



ACCEPTS:



A GBC® AUTOFEED+ 150X CROSS CUT SHREDDER

For 1 or 2 users; automated cross-cut shredding capacity of up to 150 sheets. Bypass slot for up to 8 sheets. Security stop feature; viewing window; quiet operation. Two year machine/eight year cutter warranty. Dimensions: 15" W×17" D×25" H.



ACCEPTS:



B GBC® AUTOFEED+ 150M MICRO CUT SHREDDER

For one to two users. Simply toss in the sheets and shut the lid to start automatic shredding. Quiet operation lets you work uninterrupted while it shreds. Micro cut; jam free technology with indicator light, prevents paper jams. Durable, self-clean cutters. Two year machine/eight year cutter warranty. Dimensions: 15" W × 17" D × 25" H.



ACCEPTS:



C FELLOWES® AUTOMAX™ 200C CROSS CUT SHREDDER

Single user model. AccuFeed™ technology for true walk-away shredding. Auto Reverse stops and reverses paper if a jam occurs. Energy saving Sleep Mode feature shuts down shredder after 2 minutes of inactivity. SilentShred™ ultra-quiet performance for shared workspaces. Two year machine/seven year cutter warranty. Dimensions: 13.63" W×19.94" D×22.19" H.



ACCEPTS:



D GBC® AUTOFEED+ 230X CROSS CUT SHREDDER

For 1-5 users. Auto Jam reverse. 9" entry width. 35 minute usage on/45 minute cooling off. Two year machine/ten year cutter warranty. Dimensions: 17" W×19" D×29" H.



ACCEPTS:



E FELLOWES® AUTOMAX™ 200M MICRO CUT SHREDDER

Single user mode. AccuFeed™ technology for true walk-away shredding experience. Auto Reverse stops and reverses paper if a jam occurs. Energy saving Sleep Mode feature shuts down the shredder after 2 minutes of inactivity. SilentShred™ offers ultra-quiet performance for shared workspaces. Two year machine/seven year cutter warranty. Dimensions: 13.63" W×19.94" D×22.19" H.

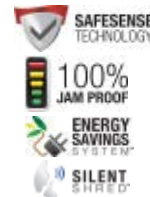

ACCEPTS:



F FELLOWES® 125CI JAM PROOF CROSS CUT SHREDDER

For 1-5 users. Patented SafeSense® technology; 100% Jam Proof System eliminates paper jams. Energy Savings system reduces energy consumption by up to 70%, compared to conventional commercial shredders during normal usage. Approved for Government use. Two year machine/lifetime cutter warranty. Dimensions: 11.25" W×21.1" D×29" H.

ORDER NUMBER	MODEL NUMBER	DUTY CYCLE (MINUTES)	SHRED SIZE AND SECURITY LEVEL	SHEET CAPACITY	WASTEBASKET (GAL./L)	SPEED (FT./MIN.)	NOISE LEVEL	BAGS ORDER NUMBER
A	WSM1757604	30 on / 45 off	5/32" × 1 3/16" (P4)	8 (150 auto)	11.6 / 43.9	5.9	55 dB	33816-65016
B	WSM1757605	30 on / 45 off	3/32" × 3/8" (P5)	6 (150 auto)	11.6 / 43.9	5.9	55 dB	33816-65016
C	4653501	25 on / 25 off	5/32" × 1 1/2" (P4)	10 (200 auto)	8.5 / 32	11	60 dB	77511-36053
D	WSM1757606	30 on / 45 off	5/32" × 1 3/16" (P4)	10 (230 auto)	16 / 60.6	7.2	55 dB	33816-65016
E	4656201	25 on / 20 off	1/16" × 9/16" (P5)	10 (200 auto)	8.5 / 32	9	60 dB	77511-36053
F	3312501	continuous	5/32" × 1 1/2" (P4)	20	14 / 53	16	63 dB	77511-36054



ACCEPTS:



A GBC® AUTOFEED+ 300X CROSS CUT SHREDDER

For 5-10 users. Auto Jam reverse. 9" entry width. 60 minute usage on/45 minute cooling off. Two year machine/twenty year cutter warranty. Dimensions: 17"W×19"D×29"H.



ACCEPTS:



B GBC® AUTOFEED+ 300M MICRO CUT SHREDDER

For 5-10 users. Auto Jam reverse. 9" entry width. 60 min. usage on/45 minute off. Two year machine/twenty year cutter warranty. Dimensions: 17"W×19"D×29"H.

NEW!



ACCEPTS:



C FELLOWES® AUTOMAX™ 350C CROSS CUT SHREDDER

For 1-3 users. Heavy use. AccuFeed system for a true walk-away shredding experience. Auto-Reverse stops and reverses paper jams. Two year machine/twenty year cutter warranty. Dimensions: 15.38"W×22.75"D×32.06"H.



ACCEPTS:



D FELLOWES® 225Ci CROSS CUT COMMERCIAL SHREDDER

For 3-5 users. Features Energy Savings System and 100% Jam Proof System, SilentShred™ and SafeSense™ auto-stop technology; 9.5" entry width. Approved for Government use (Type 111B). Dimensions: 17.13"W×17.75"D×30.75"H.

NEW!



ACCEPTS:



E GBC® MOMENTUM X22-23 CROSS CUT SHREDDER

For 10+ users. Heavy duty induction motor. New active anti-jam technology that accurately measures paper being fed in real time preventing paper jams. Two year machine/two year cutter warranty. Dimensions: 18"W×20.2"D×34.5"H.



ACCEPTS:



F FELLOWES® AUTOMAX™ 550C SHREDDER

For 3-5 users. Fellowes AccuFeed™ system for a truly walk-away shredding experience. SilentShred™ offers ultra-quiet performance for shared workspaces. Two year machine/twenty year cutter warranty. Dimensions: 17.38" W×22.75" D×35.06" H.

ORDER NUMBER	MODEL NUMBER	DUTY CYCLE (MINUTES)	SHRED SIZE AND SECURITY LEVEL	SHEET CAPACITY	WASTEBASKET (GAL./L)	SPEED (FT./MIN.)	NOISE LEVEL	BAGS ORDER NUMBER	
A	WSM1757608	300X	60 on / 45 off	5/32"×13/16" (P4)	10 (300 auto)	16 / 60.6	7.2	55 dB	33816-65010
B	WSM1757609	300M	60 on / 45 off	3/32" × 5/8" (P5)	8 (300 auto)	16 / 60.5	7.2	55 dB	33816-65010
C	4964001	350C	45 on / 30 off	5/32"×1 1/2" (P4)	12 (350 auto)	18 / 68.1	11	60 dB	77511-36054
D	3825001	225Ci	continuous	5/32"×1 1/2" (P4)	22	16 / 60.5	16	58 dB	77511-36054
E	WSM177004	X22-23	continuous	3/16"×1 1/8" (P4)	22	23 / 87.1	5.91	62 dB	33816-65015
F	4963001	550C	continuous	5/32"×1 1/2" (P4)	14 (550 auto)	22 / 83.3	11	60 dB	77511-36054

Shredders



ACCEPTS:



ACCEPTS:



ACCEPTS:



A IDEAL® MBM DESTROY IT® 2604 SHREDDER

Centralized office shredder; wide 10¼" feed opening. Motor rated for continuous duty. Auto start/stop via a photocell. Machine stops automatically when bag is full or if paper jams. With large waste bin and automatic oiler. Dimensions: 19½"W×18½"D×36½"H.

B IDEAL® MBM DESTROYIT® 4002CC CROSS CUT SHREDDER

Centralized office shredder; automatic oil injection; 16" feed opening. Auto bin full cut-off. Quiet and powerful single-phase motor rated for continuous use. Dimensions: 25¼"W×23¼"D×38¼"H.

C GBC® AUTOFEED+ 600X CROSS CUT SHREDDER

For 10-20 users. 9" entry width. 240 minute continuous usage on/no cool off needed. Two year machine/twenty year cutter warranty. Dimensions: 21"W×23"D×38"H.

	ORDER NUMBER	MODEL NUMBER	DUTY CYCLE (MINUTES)	SHRED SIZE AND SECURITY LEVEL	SHEET CAPACITY	WASTEBASKET (GAL./L)	SPEED (FT./MIN.)	NOISE LEVEL
A1	DSH0362L	2604CC	continuous	¾"×1½" (P4)	23-25	26/98.4	24	68 dB
A2	DSH0364	2604SMC	continuous	½"×¾" (P7)	6-8	26/98.4	28	68.8 dB
B	DSH0393	4002CC	continuous	¾"×1½" (P4)	24	44/166.5	25	73.1 dB
C	WSM1757510	600X	240 continuous	½"×1¾" (P4)	15 (600 auto)	29/109.7	15.9	55 dB



NEW!

D ROYAL SOVEREIGN® SHREDDER LUBRICANT SHEETS

Simply feed the sheet into your shredder just like any other document. The encapsulated oil is specially formulated to evenly lubricate the cutting blades. Using the sheets regularly helps prevent paper clogging and ensure your shredder maintains a clean cut. White. 10/pkg.

ORDER NUMBER	UNIT
RS-SLS	PK



E FELLOWES® SHREDDER BAGS

ORDER NUMBER	DESCRIPTION	UNIT
FELLOWES®		
1	77511-36052 24"W×9"D×26"H	100/CT
2	77511-36053 29"W×14"D×30"H	100/CT
3	77511-36054 30½"W×13"D×40¼"H	50/CT
4	77511-36056 33"W×15"D×39½"H	50/CT
5	43859-48711 44"W×21"D×48"H	50/CT
GBC®		
6	33816-65010 13"W×14"D×38"H	25/BX
7	33816-65015 15"W×18"D×48"H	25/BX
8	33816-65016 16"W×17"D×25"H	100/BX
9	33816-00137 24"W×18"D×48"H	100/BX



F FELLOWES® POWERSHRED® SHREDDER OIL

Regular use maintains shredders in peak condition. Convenient 12-oz. squeeze bottle with extended nozzle.

ORDER NUMBER	UNIT
77511-35250	EA

SHARP®

Be Original.

Simplifying the Complicated



Scientific

Whether it's math, advanced math, statistics, biology, chemistry or sciences, we have you covered with a vast assortment of models and functions, including WriteView models.

Printing

A reliable and trusted business partner, works hard for and with you. Featuring keys with antimicrobial protection and 2-year warranty.



Handheld/ Desktop

New Professional Series with a modern and clean design, featuring XL displays, practical layout and enhanced functionality.

Financial & Business

Great companion for business students and professionals, alike. Featuring 10-digit 2-line display, it's perfect for applications in finance, accounting, economics, banking, real-estate, sales and more.



A VICTOR® HEAVY DUTY PRINTING CALCULATOR

- AC powered
- Twelve-digit fluorescent display
- Prints in two colours at 4.6 lines/second
- Cost/sell/margin calculation, tax functions
- Contains a minimum of 45% post-consumer recycled material
- Three-year warranty
- 8½" W×12¼" D×3" H
- Uses R3027 black/red ribbon



ORDER NUMBER	DESCRIPTION	UNIT
1460-4	12 digit	EA

C SHARP® PRINT/DISPLAY CALCULATOR

- AC powered
- Twelve-digit fluorescent display
- Prints in two colours at 4.8 lines/second
- Cost/sell/margin calculation, tax functions, exchange function
- Clock/calendar functions, time calculation
- Two-year warranty
- 9" W×13½" D×3½" H
- Uses R3027 black/red ribbon



ORDER NUMBER	DESCRIPTION	UNIT
EL-2630PIII	12 digit	EA



B SHARP® PRINTING CALCULATOR

- AC powered
- 12-digit fluorescent display
- Prints 2 lines/second
- 2-colour printout
- Cost/sell/margin calculation, tax functions, clock/calendar functions & time calculation
- Keys engineered with Microban® antimicrobial protection
- 8¼" W×12½" D×3¼" H
- Two-year warranty
- Uses EA-772R ink roller



ORDER NUMBER	DESCRIPTION	UNIT
EL-2201RII	12 digit	EA



D CASIO® PRINTING CALCULATOR

- Dual power (AC adaptor included)
- Twelve-digit LCD display
- After-Print-Function and Re-Print-Function
- Prints 2.0 lines/second
- Cost/sell/margin calculation, tax functions, currency conversion, decimal selector, 3-digit comma marker, double-zero key, independent memory, rounding selector, 150 step check and edit
- 4" W×8½" D×1½" H
- Uses R1180 ink roller



ORDER NUMBER	DESCRIPTION	UNIT
HR-10RC	12 digit	EA



F VICTOR® HEAVY DUTY PRINTING CALCULATOR

- Dual power (AC adaptor included)
- Twelve-digit display
- After-Print and Re-Print Function
- Prints 2.0 lines/second
- Cost/sell/margin calculation, tax function, currency conversion, decimal selector, 3-digit comma marker, double zero key, independent memory, item counter, rapid correction key.
- 6½" W×11½" D×2½" H
- Uses R1427 ink roller



ORDER NUMBER	DESCRIPTION	UNIT
HR-170RC	12 digit	EA

ORDER NUMBER	DESCRIPTION	UNIT
1240-3A	12 digit	EA



AntiMicrobial Series
Silver particles provide antimicrobial protection



G VICTOR® COMPACT DESKTOP CALCULATOR

- Contains 20% recycled plastic
- AC/DC powered
- Extra Large twelve-digit LCD display
- Prints in two colours at 2.3 lines/second
- Tax keys, cost/sell/margin keys, change sign, backspace key, time/date feature, 4 key memory
- 6" W×7½" D×1½" H
- Two-year warranty
- Uses R1427 ink roller



ORDER NUMBER	DESCRIPTION	UNIT
1208-2	12 digit	EA

H SHARP® PRINTING CALCULATOR

- AC powered
- Twelve-digit fluorescent display
- Prints in two colours at 4.3 lines/second
- Cost/sell/margin calculation, tax functions, exchange function
- Clock/calendar functions, time calculation
- Two-year warranty
- 8¾" W×12½" D×3" H
- Uses R3027 black/red ribbon



ORDER NUMBER	DESCRIPTION	UNIT
EL-2615PIII	12 digit	EA



✓ 150%
LARGER PRINT



A VICTOR® BIG PRINT™ THERMAL CALCULATOR

- AC powered
- Prints 6 lines/second; thermal 10-digit Big Print™ or regular 12-digit print
- Cost/sell/margin calculation; tax functions; selectable rounding; independent memory
- Time/date feature
- Two-year warranty
- 7¼" W×9½" D×2½" H

ORDER NUMBER	DESCRIPTION	UNIT
1310	10/12 digit	EA

VICTOR® FEATURE



B VICTOR® COMMERCIAL DESKTOP PRINTING CALCULATOR

- AC powered
- 12-digit display
- Extra large LCD display
- Prints 3 lines per second
- 2-colour printout
- Cost/sell/margin calculation
- Automatic tax keys, percentage, change sign key, item count, date/non-add key
- Selectable rounding switches and an independent memory
- Two-year warranty
- 7¾" W×9¾" D×2½" H
- Metallic Blue
- Uses R1427 ink roller

ORDER NUMBER	DESCRIPTION	UNIT
1225-3A	12 digit	EA



AntiMicrobial Series
Silver particles provide antimicrobial protection

C SHARP® PRINTING CALCULATOR

- AC powered
- Twelve-digit fluorescent display
- Prints in two colours at 3.5 lines/second
- Cost/sell/margin calculation; tax functions
- Time/date feature
- Two-year warranty
- 8¾" W×12¾" D×3" H
- Uses R3027 black/red ribbon



ORDER NUMBER	DESCRIPTION	UNIT
EL-2607R/III	12 digit	EA



D SHARP® PAPERLESS DESKTOP CALCULATOR

- AC powered
- Large twelve-digit fluorescent display
- 5-line adjustable tilt display
- Cost/sell/margin keys; tax/GT functions
- Check & correct function for up to 300 entries
- Two-year warranty
- 7.6" W×10" D×2.6" H



ORDER NUMBER	DESCRIPTION	UNIT
ELDP9001	12 digit	EA



E VICTOR® DESKTOP PRINTER CALCULATOR

- Dual power (AC adapter included)
- Large twelve-digit LCD display
- Prints in two colours at 2.7 lines/second
- Cost/sell/margin keys
- Requires 4 AA batteries (not included)
- Minimum 45% recycled plastic content
- Two-year warranty
- 7¾" W×9¾" D×2½" H
- Uses R1427 ink roller



ORDER NUMBER	DESCRIPTION	UNIT
1212-3A	12 digit	EA



AntiMicrobial Series
Silver particles provide antimicrobial protection



F VICTOR® PORTABLE PRINTING CALCULATOR

- Dual power (AC adapter included)
- Twelve-digit LCD display
- Prints 2 lines/second
- Cost/sell/margin calculation; tax functions
- Requires 4 AA batteries (not included)
- 25% recycled plastic
- Two-year warranty
- 4" W×8" D×1¾" H
- Uses R1180 ink roller



ORDER NUMBER	DESCRIPTION	UNIT
1205-4	12 digit	EA

VICTOR® FEATURE



A VICTOR® 10-DIGIT DESKTOP CALCULATOR

- Dual power (solar/battery backup)
- Large ten-digit angled LCD display
- Cost/sell/margin keys; %, √ and change keys
- Antimicrobial protection
- Contemporary black and silver design; contains 50% recycled plastic
- Two-year warranty
- 4½" W×5" H×1¼" D



ORDER NUMBER	DESCRIPTION	UNIT
1100-3A	10-digit	EA



AntiMicrobial Series
Silver particles provide antimicrobial protection

B VICTOR® EXECUTIVE DESKTOP DISPLAY CALCULATOR

- Dual power (solar/battery backup)
- Extra large 12-digit tilt LCD display
- Contains 40% recycled plastic
- Cost/sell/margin keys; automatic tax keys, %, √ and change sign keys
- 5½" W×7¾" H×1" D



ORDER NUMBER	DESCRIPTION	UNIT
1190	12-digit	EA



C VICTOR® TUFFCALC™ CALCULATOR

- Dual power
- Twelve-digit extra-large angled LCD display
- Automatic tax keys, % and √ functions
- 40% recycled plastic
- Water and shock resistant, washable with soap and water
- 4¼" W×6½" H×2" D



ORDER NUMBER	DESCRIPTION	UNIT
99901	12-digit	EA

D VICTOR® 12-DIGIT DESKTOP DISPLAY CALCULATOR

- Dual power
- Twelve-digit angled LCD display
- Mark-up function
- 7½" W×6" H×1½" D



ORDER NUMBER	DESCRIPTION	UNIT
2140	12-digit	EA

E MERANGUE DESKTOP CALCULATOR

- Dual power
- Twelve-digit angled LCD display
- 5¾" W×4" H×½" D

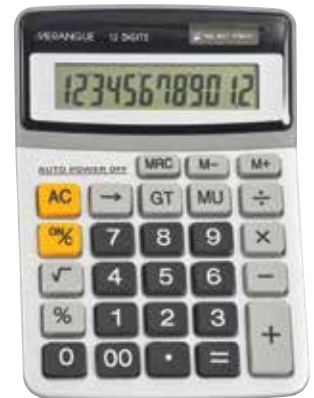

ORDER NUMBER	DESCRIPTION	UNIT
1080-9591-00-000	12-digit	EA

F AUREX® DESKTOP DISPLAY CALCULATOR

- Dual power
- Twelve-digit adjustable tilt LCD display
- Tax functions; decimal settings and rounding
- Memory, % and √ functions
- 5½" W×7¼" H×1¼" D



ORDER NUMBER	DESCRIPTION	UNIT
EDC-8312II	12-digit	EA

G AUREX® MINI DESKTOP DISPLAY CALCULATOR

- Dual power
- Eight-digit angled LCD display
- Memory, % and √ functions
- 4" W×4¾" H×1" D



ORDER NUMBER	DESCRIPTION	UNIT
EDC-4300	8-digit	EA

A SHARP® DESKTOP DISPLAY CALCULATOR

- Dual power
- Ten-digit tilt LCD display
- Cost/sell/margin calculation; tax functions
- 3 4/10" W×6 5/16" H×1 1/2" D



ORDER NUMBER	DESCRIPTION	UNIT
EL-330WB	10-digit	EA

B OP BRAND 12-DIGIT DESKTOP BUSINESS CALCULATOR

- Dual power
- Twelve-digit LCD display
- Gross profit function, tax +/- function keys
- 6 1/4" W×7 7/8" H×3 1/10" D



ORDER NUMBER	DESCRIPTION	UNIT
27811-01001	12-digit	EA



Our Brand, YOUR Savings!

C CASIO® PAPERLESS DESKTOP CALCULATOR

- Review & edit up to 300 entries. Recheck feature beeps if numbers vary during re-entry
- Dual power
- Twelve-digit angled display
- Rounding and decimal selectors with sub and grand total
- Quick correction key
- 5 3/8" W×7 7/8" H×1 1/16" D



ORDER NUMBER	DESCRIPTION	UNIT
DJ-120Dplus	12-digit	EA

D SHARP® MINI DESKTOP DISPLAY CALCULATOR

- Dual power
- Eight-digit angled LCD display
- Tax functions
- 3 4/100" W×4 4/8" H×1 1/25" D



ORDER NUMBER	DESCRIPTION	UNIT
EL-310WB	8-digit	EA

E SHARP® DESKTOP DISPLAY CALCULATOR

- Dual power
- XL Twelve-digit LCD display
- Cost/sell/margin calculation
- Kick-stand display
- 4 4/100" W×6 6/100" H×1 1/25" D



ORDER NUMBER	DESCRIPTION	UNIT
EL-334WB	12-digit	EA

F VICTOR® DESKTOP BUSINESS CALCULATOR

- Dual power
- Twelve-digit tilt LCD display
- Cost/sell/margin calculation; tax functions; decimal settings and rounding
- 7 7/8" W×5 1/8" H×1 3/4" D



ORDER NUMBER	DESCRIPTION	UNIT
9700	12-digit	EA



G SHARP® DESKTOP CALCULATOR

- Dual power
- Twelve-digit angled LCD display
- Tax function, GT function
- Four-key memory; two-key roll over
- 3 2/5" W×1 1/10" H×4 3/5" D



ORDER NUMBER	DESCRIPTION	UNIT
1 ELI24TBGY	White/Grey	EA
2 ELI24TBPK	White/Pink	EA

H AUREX® DESKTOP DISPLAY CALCULATOR

- Dual power
- Big number 10-digit adjustable tilt display
- Four-key independent memory; %, and square root
- 7 1/2" W×6" H×1 1/4" D



ORDER NUMBER	DESCRIPTION	UNIT
EDC-4610II	10-digit	EA



A OP BRAND HARD CASE HAND HELD CALCULATOR

- Dual power
- Eight-digit display
- 3-key individual memory
- 2¾" W×4½" H×½" D

ORDER NUMBER	DESCRIPTION	UNIT
27811-01000	8-digit	EA

Our Brand, YOUR Savings !



B VICTOR® COMPACT HAND HELD POCKET CALCULATOR

- Dual power
- Extra large eight-digit LCD display
- Antimicrobial non-slip rubber keys and protective hard shell slide cover housing
- 50% recycled plastic
- Three-key memory, %, √ keys
- 2½" W×4¼" H×¼" D

ORDER NUMBER	DESCRIPTION	UNIT
900VIC	8-digit	EA



AntiMicrobial Series
Silver particles provide antimicrobial protection

C VICTOR® 8 DIGIT POCKET CALCULATOR

- Dual power
- Extra large eight-digit LCD display
- Ergonomic shape with easy-grip contours
- %, √, sign change keys
- Non-slip rubber keys
- 2½" W×4" H×¼" D

ORDER NUMBER	DESCRIPTION	UNIT
700	8-digit	EA



E SHARP® HAND HELD CALCULATOR

- Dual power
- Eight-digit
- 3-key memory, %, √, sign change, large + key
- Hard case
- 2½" W×4½" H×¼" D

ORDER NUMBER	DESCRIPTION	UNIT
EL-243SB	8-digit	EA



D SHARP® HAND HELD CALCULATOR

- Dual power
- Large eight-digit display
- Tax functions
- Memory, %, √, sign change functions
- 2¾" W×4¾" H×½" D

ORDER NUMBER	DESCRIPTION	UNIT
EL-244WB	8-digit	EA

F SHARP® METRIC CONVERSION CALCULATOR

- Dual power
- Ten-digit LCD display
- Exchange function, 44 built-in conversions
- 2¾" W×4¾" H×¼" D

ORDER NUMBER	DESCRIPTION	UNIT
EL-344RB	10-digit	EA



G SHARP® BUSINESS/ FINANCIAL CALCULATOR

- Battery powered
- Ten-digit LCD display
- Cost/sell/margin, amortization payments, interest, savings bonds, day/date, depreciation, currency exchange calculations
- 3¾" W×6" H×½" D

ORDER NUMBER	DESCRIPTION	UNIT
EL-738XTB	10-digit	EA



NEW!

A CASIO® FX-260 SOLAR II SCIENTIFIC CALCULATOR

- Solar power
- 10 + 2 digit display
- 144 functions, fractions, exponential, scientific notation, single variable statistics
- Permutation, combination & random number
- Trigonometric inverse functions
- Logarithmic functions
- Slide-on hard case
- 2¾" W × 4¾" D × ¾" H



ORDER NUMBER	DESCRIPTION	UNIT
FX-260SOLARII	144 Functions	EA

B SHARP® SCIENTIFIC CALCULATOR

- Battery powered
- Ten+1-digit LCD display
- 169 functions; fraction function; one-variable statistics; Direct Algebraic Logic shows equation during entry; last answer recall
- 2½" W × 4¾" H × ¾" D

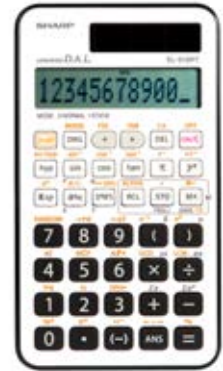

ORDER NUMBER	DESCRIPTION	UNIT
EL-510RTB	169 Functions	EA

C SHARP® SCIENTIFIC CALCULATOR

- Dual power
- Ten-digit two-line LCD display
- 273 functions, fraction, constant and regression calculations
- 3¾" W × 5¾" H × ¾" D



ORDER NUMBER	DESCRIPTION	UNIT
EL-531XTBWH	273 functions	EA

D SHARP® SCIENTIFIC CALCULATOR

- Dual power; 420 functions
- Two-line equation/numeric ten-digit LCD display
- 52 physical constants
- 44 unit conversions
- 3¾" W × 5¾" H × ¾" D



ORDER NUMBER	DESCRIPTION	UNIT
EL-520XTBBK	420 functions	EA

E VICTOR® SCIENTIFIC CALCULATOR

- Battery power
- 10-digit LCD display
- Hex/Dec/Oct/Bin and decimal degrees conversion
- Logarithms, reciprocals, powers, roots, factorials, trigs, hyperbolic trigs and 1-variable statistics
- Hard folding shell cover
- 2¾" W × 4¾" H × ½" D



ORDER NUMBER	UNIT
920	EA

F SHARP® SCIENTIFIC CALCULATOR

- Dual power
- Ten-digit two-line LCD display
- 470 functions, 44 metric conversions, 52 physical constants, constant and fraction calculations, 2-variable statistics
- 3¾" W × 5¾" H × ¾" D



ORDER NUMBER	DESCRIPTION	UNIT
EL-546XTBSL	470 functions	EA

G SHARP® WRITE VIEW™ SCIENTIFIC CALCULATOR

- Dual power
- 16-Digit, 4-line LCD display
- WriteView™ display
- 640 functions, 7 modes, 8 temporary and 4 definable memory buttons
- 3¾" W × 6¾" H × ¾" D



ORDER NUMBER	DESCRIPTION	UNIT
ELW516XGBSL	640 functions	EA

H CASIO® FX300MS PLUSII SCIENTIFIC CALCULATOR

- Dual power
- Ten-digit two-line LCD display
- 240 functions, 2 variable statistics, advanced V.P.A.M algebraic processor.
- Regression analysis feature and auto replay function.
- 3½" W × 7½" H × 6¾" D.



ORDER NUMBER	DESCRIPTION	UNIT
FX300MSPLUS2	240 functions	EA



DYMO®

LetraTag® 200B Bluetooth®

Bluetooth Connected

Electronic Label Maker

Intuitive mobile labelling for home, on-the-go, school or home office!



NEW

Portable Label Maker With Bluetooth® Wireless Technology



DYMO® LetraTag® Connect - Easily Design Your Labels!



Complete your work professionally with sustainability in mind!



*Authentic DYMO® LetraTag®, LabelWriter™ Paper labels. **External cassette of LetraTag®, D1®, RHINO IND



A DYMO® LABELWRITER® WIFI THERMAL PRINTER

Built-in Wi-Fi® for cable-free label printing. DYMO Connect mobile app for creating and printing labels using Wi-Fi® from smartphones and tablets. Direct thermal print technology eliminates the need for desktop printer ink or toner. 600×300 dpi resolution. DYMO Label Software allows for quick design and printing of labels from a Mac® or PC, or use Microsoft® Office plugins to print directly from Word, Excel® or Outlook®. Prints up to 51 labels per minute.

ORDER NUMBER	DESCRIPTION	UNIT
2002150	Black	EA



B DYMO® LABELWRITER® 5XL THERMAL LABEL PRINTER

Ideal for your ecommerce business - compatible with major online selling platforms. 300 dpi printing. LAN network connectivity allows you to connect to your wireless network via a cable. Prints 4"×6" shipping labels. Up to 53 labels per minute.

ORDER NUMBER	DESCRIPTION	UNIT
1 2112554	Thermal label printer	EA
2 1744907	4"×6", Label White, 220 labels/rl	1 RL/PK

C DYMO® LABELWRITER® 550 TURBO THERMAL LABEL PRINTER

600×300 dpi resolution. Prints directly from Microsoft Word®, Excel®, Outlook®, Mac Address Book and more. Prints up to 90 labels per minute.



ORDER NUMBER	UNIT
2112553	EA



D DYMO® LETRATAG® BLUETOOTH LABELLER

Create and print custom labels directly from smartphone or tablet. Connects seamlessly to the labeller via Bluetooth and synchronizing with the free DYMO Connect mobile app. Compatible with DYMO Authentic LetraTag® consumables for high quality print on paper, plastic, and iron-on. Black.



ORDER NUMBER	UNIT
2179979	EA

E DYMO® LABELWRITER® 550 THERMAL LABEL PRINTER

600×300 dpi resolution. Prints directly from Microsoft Word®, Excel®, Outlook®, Mac Address Book and more. Prints up to 62 labels per minute.



ORDER NO.	UNIT
2112552	EA



G DYMO® LABELWRITER® PRINTER LABELS

ORDER NO.	DESCRIPTION	LABELS	UNIT
1 30251	Standard address label, 1½"×3½"	260	2 RL/PK
2 30320	Standard address label, 1½"×3½"	520	2 RL/PK
3 30252	Standard address label, 1½"×3½"	700	2 RL/PK
4 30254	Clear address label, 1½"×3½"	130	1 RL/PK
5 30321	Large address label, 1½"×3½"	520	2 RL/PK
6 30323	Shipping label, 2½"×4"	220	1 RL/PK
7 30256	Shipping label, 2½"×4"	300	1 RL/PK
8 1744907	Shipping label, 4"×6"	220	1 RL/PK
9 30327	File folder label, ¾"×3¼"	260	2 RL/PK
10 30333	Multi-purpose 2-up label, ½"×1"	1000	1 RL/PK
11 30332	Multi-purpose label, 1"×1"	750	1 RL/PK
12 30334	Multi-purpose label, 2¼"×1¼"	1000	1 RL/PK
13 30336	Multi-purpose label, 1"×2½"	500	1 RL/PK
14 30324	Multi-purpose label, 2½"×2¾"	320	1 RL/PK
15 2133382	Multi-purpose Yellow label, 2½"×4"	220	1 RL/PK
16 2133383	Multi-purpose Red label, 2½"×4"	220	1 RL/PK

F AVERY® LABEL PRINTER LABELS

Print one address at a time. Compatible with Seiko Instrument® or CoStar® label printers. Permanent adhesive.



ORDER NUMBER	DESCRIPTION	UNIT
1 67933-04150	White, 3½"×1½"	260/BX
2 67933-04153	White, 2½"×4"	140/BX



Label Makers – DYMO®

A DYMO® LABELMANAGER® 210D & 210D KIT

Features large display with print preview. Easy, intuitive operation. Ergonomic typewriter-style keyboard. Prints one or two lines per label on ¼", ⅜" or ½" tape (6, 9 or 12 mm). Text orientation & alignment options; 6 font sizes, 6 styles, 8 different boxes or underline styles. Memory stores up to 9 labels. Multi-lingual. Kit includes 210D label printer, carrying case, AC adapter, 2 tapes and batteries.



ORDER NUMBER	DESCRIPTION	UNIT
1 1738345	LabelManager® 210D	EA
2 1738976	LabelManager® 210D Kit	EA

C DYMO® LABELMANAGER® 280 RECHARGEABLE LABEL MAKER

Comfortable, easy to use QWERTY keyboard. Prints labels in 6 font sizes, 18 text styles, 8 boxes plus underline, and 221 symbols and clip-art images. Stores up to 9 frequently-used labels. Uses Dymo D1 labels (6, 9, 12 mm) widths. Rechargeable battery pack; PC and Mac connectivity allows customization.



ORDER NUMBER	UNIT
1815990	EA

E DYMO® LETRATAG® PLUS LT-100T PERSONAL LABEL MAKER

Features computer-style keyboard, large 13-character display with print preview showing font effects. Direct thermal technology prints high-quality labels on ½" (12 mm) LetraTag® tapes. Includes one roll white paper tape, one roll clear plastic tape. Uses 4 AA batteries (not included).



ORDER NUMBER	UNIT
1733013	EA

G DYMO® LETRATAG® TAPES

One size: 12 mm x 4 m. Colours: **1** White, **2** Yellow, **3** Red, **5** Blue.



ORDER NUMBER	DESCRIPTION	UNIT
1 9133	Plastic, specify colour	EA
2 16952	Plastic, Black on Clear	EA
3 91330	Paper, White	EA
4 91338	Metallic, Silver	EA

B DYMO® LABELMANAGER® 160 LABEL MAKER

Features large LCD display with print preview. Computer style QWERTY keyboard with one-touch smart keys for fast text formatting (size, bold, italic, underline, vertical) and quick access key for punctuation. Offers six sizes, eight styles, four boxes and 228 symbols and images. Uses DYMO® D1™ ¼", ⅜" and ½" tapes (6, 9 or 12 mm). Requires 6 AAA batteries or AC adapter (both sold separately).



ORDER NUMBER	DESCRIPTION	UNIT
1 1790415	LabelManager® 160	EA
2 40077	Adapter	EA

D DYMO® LETRATAG® PLUS LT-100H PERSONAL LABEL MAKER

Features 13-character display, 9-label memory, 2-line printing, 5 font sizes, 8 box styles, 195 symbols. Auto power off feature, date/time function, 3 language options. Uses four AA batteries.



ORDER NUMBER	UNIT
21455	EA

F DYMO® D1™ TAPES

For LabelPoint, LabelManager® and LabelWriter® Duo machines.



ORDER NUMBER	DESCRIPTION	UNIT
1 41913	Black on White, ⅜" x 23'	EA
2 45010	Black on Clear, ½" x 23'	EA
3 45013	Black on White, ½" x 23'	EA
4 S0720540	Blue on White, ½" x 23'	EA
5 45018	Black on Yellow, ½" x 23'	EA
6 1978365	White on Black, ½" x 10'	EA
7 45803	Black on White, ¾" x 23'	EA

NEW!

H DYMO® RHINO LABELS

For use with Rhino label makers. Easy peel split back tape.



ORDER NUMBER	DESCRIPTION	UNIT
1 18483	Permanent poly, ½" (12 mm)	EA
2 18488	Flexible nylon, ½" (12 mm)	EA
3 18489	Flexible nylon, ¾" (19 mm)	EA



A BROTHER HIGH-SPEED PROFESSIONAL LABEL PRINTER

Print amazing black/red labels using DK-2251. Super-fast, printing up to 93 standard address labels per minute with black text at 300dpi. Prints Brother DK pre-sized, easy-peel labels and continuous-length paper and film tapes. Auto cutter enables banners and signs up to 3 ft. long. Integrates with Microsoft® Word®, Excel® and Outlook®. Compatible with Windows® and Mac®. Convenient, drop-in rolls. No ink or toner needed.

ORDER NUMBER	UNIT
QL-800	EA



B BROTHER LABEL PRINTER WITH WIRELESS NETWORKING

Print amazing black/red labels using DK-2251. Ultra-fast, up to 110 standard address labels per minute with black text at 300dpi. Create and print labels from your mobile device with Brother™ iPrint&Scan and Wi-Fi Direct™. Prints Brother DK pre-sized, easy-peel labels and continuous-length paper and film tapes. Auto cutter enables banners and signs up to 3 ft. long. Convenient drop-in rolls. No ink or toner needed. Windows® and Mac® compatible.

ORDER NUMBER	UNIT
QL-810WC	EA

C BROTHER DESKTOP LABEL PRINTER

Economic label printer that can print labels up to 2.4" (62mm) wide and up to 44 labels per minute at 300x600 dpi. Prints Brother DK pre-sized, easy-peel labels and continuous-length paper and film tapes. Auto cutter enables banners and signs up to 3 ft. long. Design and print customized labels from Desktop Computer with Brother P-touch Editor Software. Windows, Linux and Mac® compatible. Uses convenient, drop-in rolls. Includes USB cable and starter supply of labels.



ORDER NUMBER	UNIT
QL-600	EA



D BROTHER DK-SERIES PAPER LABELS & TAPES

ORDER NUMBER	DESCRIPTION	UNIT
1 DK1201	Standard address label, 1.1"×3.5"	400/PK
2 DK1202	Shipping label, 2.4"×3.9"	300/PK
3 DK1203	File folder label, 0.66"×3.4"	300/PK
4 DK2211	Film tape, white 1.1"×50'	PK
5 DK2210	Paper tape, 1.1"×100'	PK
6 DK2212	Film tape, white 2.4"×50'	PK
7 DK2205	Paper tape, 2.4"×100'	PK
8 DK2251	Paper tape, black/red on white 2.4"×50'	PK



E BROTHER QL1100 WIDE FORMAT PROFESSIONAL LABEL PRINTER

High speed label printer with USB Host interface. Prints on labels up to 4" wide. 300x300 dpi resolution. Automatic crop feature automatically identifies and crops individual labels (Windows® only). Built-in memory to store templates. Prints up to 69 standard address label per minute with black text.

ORDER NUMBER	DESCRIPTION	UNIT
1 QL1100	Label printer	EA
BROTHER® DK PAPER SHIPPING LABELS		
For PL1050, QL1060N, QL1100 and QL1110NWB.		
2 DK1247	Black on White, 4½"×6 13/32"	180/RL
BROTHER® DK CONTINUOUS PAPER TAPE		
Can be cut to any size. For use with QL1100 and QL1110NWB.		
3 DK2246	Black on White, 4½"×100'	EA



F BROTHER QL1110NWB WIDE FORMAT PROFESSIONAL LABEL PRINTER

High speed label printer engineered with flexible connectivity option. Ethernet and wireless interfaces. Prints on labels up to 4" wide. 300x300 dpi resolution. Automatic crop feature automatically identifies and crops individual labels (Windows® only). Built-in memory to store templates. Prints up to 69 standard address label per minute with black text.

ORDER NUMBER	UNIT
QL1110NWB	EA

NEW!

NEW!



A BROTHER HANDY LABEL MAKER

Lightweight and portable. Prints up to 2 lines of text. Stores up to 3 labels for quick reprinting. Uses Brother "M" tapes in a variety of colours, and two widths - 9mm (~ 3/8") and 12mm (~ 1/2"). Operates on 4 "AAA" batteries (not included). Easy-to-type QWERTY /Easy-to-read 12-character display.

ORDER NUMBER	UNIT
PT-M95	EA



NEW!

B BROTHER DESKTOP LABELLER WITH AC ADAPTER

Display screen allows you to view text and layout before printing. Uses durable, easy-peel, laminated tapes in widths up to 18mm (approx. 3/4"). Prints labels with up to 5 lines of text. Includes 15 fonts, 13 styles, over 700 symbols, bar codes and more. Powered by AC adapter (included) or 6 "AA" batteries (sold separately).

ORDER NUMBER	UNIT
PT-D410	EA



C BROTHER PORTABLE LABEL MAKER

Lightweight and portable. Stores up to 15 labels for quick reprinting. Easy-view graphical display for easy preview before printing. 3 fonts, 14 frames and more than 250 symbols. Useful cable labelling feature to easily organize your wires and cables. Works with 6 x "AAA" batteries (not included) or optional AC adapter.

ORDER NUMBER	UNIT
PT-H110	EA



D BROTHER EASY-TO-USE LABEL MAKER

Prints up to 2-lines on labels up to 12mm wide (approx. 1/2"). Stores up to 30 labels for quick reprinting. Uses a variety of easy to apply "TZe" tapes. Works with 6 x "AAA" batteries or AC adapter (both sold separately). Graphical display – See how your label will look before you print.

ORDER NUMBER	DESCRIPTION	UNIT
1 PT-D210BK	Labeller	EA
2 AD24ESA01	AC Adapter	EA



NEW!

E BROTHER PC-CONNECTABLE LABEL MAKER

Use stand-alone, or connected to a PC or Mac for added design capabilities. Uses durable, easy-peel, laminated tapes in widths up to 18mm (approx. 3/4"). Prints labels with up to 5 lines of text. Includes 0.7" (18mm) "TZe" starter tape, AC power adapter and USB cable. Includes 16 fonts, 15 styles, over 800 symbols, bar codes and more.

ORDER NUMBER	UNIT
PT-D460BT	EA



NEW!

F BROTHER PC-CONNECTABLE LABEL MAKER WITH COLOUR DISPLAY

Use stand-alone, or connected to a PC or Mac for added design capabilities. Uses durable, easy-peel, laminated tapes in widths up to 24mm (approx. 1"). Prints labels with up to 7 lines of text. Includes 17 fonts, 17 styles, over 900 symbols, bar codes and more. Includes 0.94" (24mm) "TZe" starter tape, AC power adapter and USB cable.

ORDER NUMBER	UNIT
PT-D610BT	EA



A BROTHER P-TOUCH® TZE TAPES

For P-Touch® GL100*, 200, 300, 310, 320, 330, 520, 530, 1000*, 1090*, 1180*, 1200*, 1230PC*, 1250*, 1290*, 1500PC*, 1700AD, 1750, 1800, 1830, 1880, 1900, 1950, 2030, 2100, 2200, 2300, 2430PC, 2500PC, 2600, 2700, 2730. *Not compatible with 18 mm (3/4") or 24 mm (1"). 26' per tape.

ORDER NUMBER	DESCRIPTION	UNIT
1	TZE211 6 mm / 1/4", Black on White	EA
2	TZE315 6 mm / 1/4", White on Black	EA
3	TZE111 6 mm / 1/4", Black on Clear	EA
4	TZE221 9 mm / 3/8", Black on White	EA
5	TZE223 9 mm / 3/8", Blue on White	EA
6	TZE222 9 mm / 3/8", Red on White	EA
7	TZE325 9 mm / 3/8", White on Black	EA
8	TZE121 9 mm / 3/8", Black on Clear	EA
9	TZE231 12 mm / 1/2", Black on White	EA
10	TZE232 12 mm / 1/2", Red on White	EA
11	TZE233 12 mm / 1/2", Blue on White	EA
12	TZE131 12 mm / 1/2", Black on Clear	EA
13	TZE135 12 mm / 1/2", White on Clear	EA
14	TZE631 12 mm / 1/2", Black on Yellow	EA
15	TZE335 12 mm / 1/2", White on Black	EA
16	TZE241 18 mm / 3/4", Black on White	EA
17	TZE242 18 mm / 3/4", Red on White	EA
18	TZE243 18 mm / 3/4", Blue on White	EA
19	TZE141 18 mm / 3/4", Black on Clear	EA
20	TZE641 18 mm / 3/4", Black on Yellow	EA
21	TZE345 18 mm / 3/4", White on Black	EA
22	TZE251 24 mm / 1", Black on White	EA
23	TZE651 24 mm / 1", Black on Yellow	EA

B BROTHER P-TOUCH® TZES INDUSTRIAL TAPES

Laminated tape with stronger adhesive. For P-Touch® GL100*, 200, 300, 310, 320, 330, 520, 530, 1000, 1090, 1100SBVP, 1180, 1200, 1200S, 1230, 1250, 1280, 1290, 1400, 1500PC, 1650, 1700, 1750, 1800, 1830, 1880, 1900, 1950, 2200, 2300, 2350, 2430PC, 2500PC, 2600, 2700, 2730, 7609, 9200PC, 9200DX, 9400, 9500PC, 9600, 9700PC, 9800PCN, PTD200, PTH100. 26' per tape. Black on White.

ORDER NUMBER	DESCRIPTION	UNIT
1	TZES221 9 mm / 3/8", Black on White	EA
2	TZES231 12 mm / 1/2", Black on White	EA
3	TZES241 18 mm / 3/4", Black on White	EA
4	TZES251 24 mm / 1", Black on White	EA



C BROTHER P-TOUCH® TC TAPES

For P-Touch® 6, 15, 20 and 2000. 25' per tape.

ORDER NUMBER	DESCRIPTION	UNIT
1	TC291 9 mm / 3/8", Black on White	EA
2	TC201 12 mm / 1/2", Black on White	EA



D BROTHER P-TOUCH® M TAPES

Non-laminated. For P-Touch® 65, 70, 75, 80, 85, 90, 100, 110. 26' per tape.

ORDER NUMBER	DESCRIPTION	UNIT
1	MK221 9 mm / 3/8", Black on White	EA
2	MK231 12 mm / 1/2", Black on White	EA
3	M831 12 mm / 1/2", Black on Gold	EA

LABEL TAPE SIZING

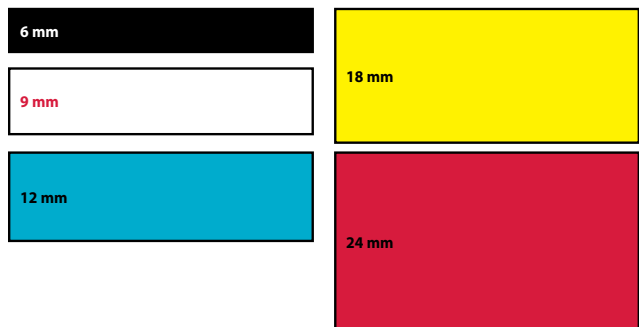



NEW!



A FELLOWES® STAR+™ 150 COMB BINDING MACHINE

For occasional binding needs in the home/small office. Maximum 3/4" comb. Vertical document loader ensures consistent punch alignment. Pull out jam-free clipping tray. Pull out comb storage tray with document/comb sizing. Two-year warranty. 17 1/16"W×9 3/16"D×3 1/8"H.

B FELLOWES® LYRA™ 3-IN-1 BINDING CENTRE

Combine stapling, 3-hole punching and comb binding in one machine. EasyPress™ patented double action staplers offers effortless stapling. Vertical loading enhances accuracy. Punches up to 30 sheets. Staples up to 30 sheets. Includes a document and comb measurement guide for ease of use. 16 5/8"W×15 4/7"D×6 1/32"H. 2-year limited warranty.

C GBC® COMBBIND® C20 BINDING SYSTEM

For offices with moderate binding needs. With ergonomic low force punch handle; two-year warranty. 21 21/32"W×9 1/4"D×18 3/4"H.



D GBC® COMBBIND® C150 BINDING MACHINE

Standard letter size manual punch and bind machine. With drawer for paper waste; two-year warranty. 15"W×12"D×9 1/2"H.

E FELLOWES® GALAXY E500 ELECTRIC HEAVY DUTY BINDING MACHINE

Removable binding system can be used separately for increased productivity. Vertical document loading ensures accurate punch alignment. Includes binding starter package. 19"W×17 3/4"D×6 1/2"H.

F GBC® COMBBIND® C450E BINDING MACHINE

Provides perfect punching and quick binding; exclusive paper separator divides stacks of paper into just the right thickness for flawless punching. Rotary dial for precise control of comb opening and closing. Limited 2-year warranty. 17 7/8"W×6 1/16"D×17 3/4"H.

	ORDER NUMBER	MODEL NUMBER	TYPE	MAXIMUM DOCUMENT SIZE	PUNCH CAPACITY	BINDING CAPACITY	MAX. COMB CAPACITY	MARGIN DEPTH SELECTOR	EDGE ALIGNMENT GUIDE
A	5006501	Star+ 150	Manual	8 1/2"×11"	15 sheets	150 sheets	3/4"	No	Yes
B	5603001	Lyra 3-in-1	Manual	8 1/2"×11"	30 sheets	300 sheets	1 1/2"	No	Yes
C	33816-50004	C20	Manual	8 3/4"×11 1/2"	20 sheets	330 sheets	1 1/2"	No	Yes
D	13465-27110	C150	Manual	8 1/2"×11"	20 sheets	500 sheets	2"	No	No
E	5218301	Galaxy E500	Electric	8 1/2"×11"	28 sheets	500 sheets	2"	Yes	Yes
F	33816-05720	C450E	Electric	8 1/2"×11"	25 sheets	500 sheets	2"	Yes	Yes



A FELLOWES® FUTURA™ OVERSIZE PRESENTATION COVERS

Designer style binding covers made from a premium heavyweight material. Oversize with rounded corners. 8¾"×11¼".

ORDER NUMBER	DESCRIPTION	UNIT
1 5224701	Black	25/PK
2 5224801	Navy	25/PK



B FELLOWES® FUTURA™ PRESENTATION COVERS

Designer style binding covers made from a premium heavyweight material. Squared corners. 8½"×11".

ORDER NUMBER	DESCRIPTION	UNIT
1 5224901	Black	25/PK
2 5224301	Frosted	25/PK



C FELLOWES® TRANSPARENT PVC COVERS

Durable plastic protects bound documents from spills and tears. Un-punched covers adapt to any binding system.

ORDER NUMBER	DESCRIPTION	UNIT
1 52311	8¾"×11¼", rounded corners	100/PK
2 52089	8½"×11", squared corners	100/PK



E FELLOWES® EXPRESSIONS™ PRESENTATION COVERS

Gives a professional look and feel to any document. Premium heavy gauge cover with textured finish. Un-punched covers adapt to any binding system. Oversize with rounded corners. 8¾"×11¼".

ORDER NUMBER	DESCRIPTION	UNIT
1 52113	Navy, linen finish	200/PK
2 52115	Black, linen finish	200/PK
3 52137	White, grain finish	200/PK



D GBC® COMBBIND® 11" PLASTIC BINDING COMBS

19-ring.

ORDER NUMBER	DESCRIPTION	UNIT
1 33816-00953	¼", 25 sheets, Black	100/BX
2 33816-00967	⅜", 60 sheets, Black	100/BX
3 33816-00981	½", 90 sheets, Black	100/BX
4 33816-00992	⅝", 130 sheets, Black	100/BX
5 33816-00997	¾", 160 sheets, Black	100/BX
6 33816-01007	1", 225 sheets, Black	100/BX
7 33816-01423	1½", 330 sheets, Black	100/BX
8 33816-01433	2", 500 sheets, Black	50/BX

LAMINATION MADE **EASY**



GBC **FOTON®30** THERMAL LAMINATOR

No Pouches. No Feeding. No Trimming. Fully Automatic.



DROP IN
ANY PROJECT



VS. POUCH
LAMINATORS



NO POUCHES
NEEDED



CORRECTS
MESSY STACKS



COMES OUT
PERFECT



A FELLOWES® SPECTRA 95 LAMINATOR

Release lever disengages pouch for re-centering or removal. Auto Shut off prevents overheating when not in use. Includes laminating starter kit. 14½"W×7"D×3 ¼"H.

B SWINGLINE® INSPIRE™ PLUS LAMINATOR

Jam release lever. Cold lamination setting. Laminates up to legal size. Includes 5 letter size pouches. 14½"W×6 ⅝"D×3 ⅜"H.



C FELLOWES® HALO™ 95 LAMINATOR

Convenient release lever allows easy pouch re-centering or removal. Auto-Shut Off saves energy and prevents overheating. Features HeatGuard technology. Hot and cold settings. Includes 10 ImageLast™ Laminating Pouches. 13½"W×4½"D×3"H.

D FELLOWES® SATURN™ 3i 95 LAMINATOR

Features HeatGuard Technology™. Hot and cold settings. Auto-shut off and jam release level. Includes 10 ImageLast laminating pouches. 17 ⅝"W×5½"D×4 ⅛"H.



E FELLOWES® SATURN™ 3i 125 LAMINATOR

Rapid 1-minute warm up with InstaHeat Technology™. Green light and audible beep indicates when machine is ready. Auto-shut off and jam release. Lamination feed sensor and exit tray. Hot and cold settings. Includes laminating starter kit. 20 1⁄8"W×5¾"D×4 ⅛"H.

F GBC® FUSION™ 3000L LAMINATOR

Tap touch user interface. Includes 30 EZUse™ Premium letter size pouches. 19 ⅞"W×10½"D×4"H.

	ORDER NUMBER	MODEL NUMBER	NUMBER OF ROLLERS	ENTRY WIDTH	HEAT-UP TIME	POUCH THICKNESS	SPEED (IN./MIN.)	WARRANTY
A	5738201	Spectra 95	2	9.5"	4 minutes	3-5 mil	12	1 year
B	64474-70185	Inspire™ Plus	2	9"	4-5 minutes	3-5 mil	19	90 day
C	5753001	Halo™ 95	2	9.5"	1 minutes	3-5 mil	12	2 year
D	5735801	Saturn™ 3i 95	2	9.5"	1 minute	3-5 mil	12	2 year
E	5736601	Saturn™ 3i 125	2	12.5"	1 minute	3-5 mil	12	2 year
F	33816-50027A	Fusion 3000L	2	12"	1.5 minutes	3-5 mil	19	3 year

Binding and Laminating – laminators



A FELLOWES® JUPITER™ 125 LAMINATOR

AutoSense system detects pouch thickness and self-adjusts to the optimal laminating setting. 100% Jam Proof laminating system: Advanced pouch tracking technology with auto-reverse, light guides and large, foldable entry and exit trays for perfect pouch guidance from start to finish. Auto shut-off saves energy and prevents overheating when not in use. Features Clean Alert System and accepts hot or cold pouches. ImageLast Jam Free pouch kit with cleaning sheet included. 21¼"W×8¾"D×5⅙"H.



B GBC® FUSION™ PLUS 7000L LAMINATOR

Auto pouch thickness detection. Auto jam detection and removal. Cold lamination setting option. Includes 50 EZUse™ Premium laminating pouches. 22¾"W×9¼"D×4¾"H.



C FELLOWES® VENUS™ 125 LAMINATOR

AutoSense system detects pouch thickness and self-adjusts to the optimal laminating setting. 100% Jam Proof laminating system: Advanced pouch tracking technology with auto-reverse, light guides and large, foldable entry and exit trays for perfect pouch guidance from start to finish. Auto shut-off saves energy and prevents overheating when not in use. Features Clean Alert System and accepts hot or cold pouches. ImageLast Jam Free pouch kit with cleaning sheet included. 21¼"W×8¾"D×5⅙"H.



D GBC® FOTON® 30 AUTOMATED LAMINATOR

Automated desktop laminator that feeds, laminates and trims with the touch of a button. Touch button interface. Auto feed and auto trim. Film indicator from low to empty. Includes starter cartridge. 22⅞"W×27⅜"D×14¾"H.



NEW!

E FELLOWES® AMARIS™ 125 LAMINATOR

100% jam proof laminating system. Advanced pouch tracking technology with auto-reverse, light guides and large, foldable entry and exit trays for perfect pouch guidance from start to finish. 8½"W×20⅝"D×6⅙"H.

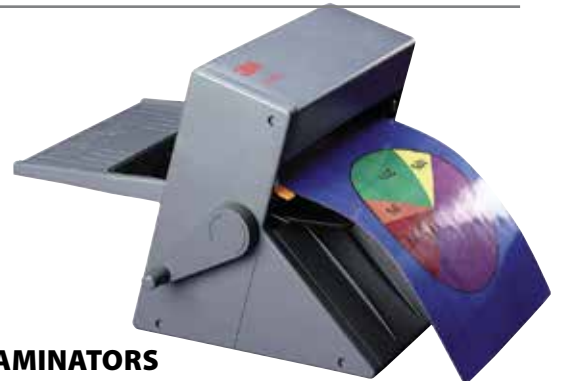

F 3M™ COOL LAMINATORS

Heat-free laminating system requires no waiting for warming up, no odors and no mess. Ideal for laminating heat-sensitive materials, inks and photographs. Handles documents up to 1/10" thick. Non-electric. Includes a 50' laminating cartridge.

	ORDER NUMBER	MODEL NUMBER	NUMBER OF ROLLERS	ENTRY WIDTH	HEAT-UP TIME	POUCH THICKNESS	SPEED (IN./MIN.)	WARRANTY
A	5746301	Jupiter™ 125	6	12.5"	1 minute	up to 10 mil	55	2 year
B	33816-50262	Fusion™ Plus 7000L	6	12"	1 minute	3-10 mil	55	3 year
C	5746101	Venus™ 125	6	12.5"	30-60 seconds	up to 10 mil	86	2 year
D	FOTON30120NA	FOTON® 30	4	11.75"	3-4 minutes	3-5 mil	29	2 year
E	8058101	Amaris™ 125	6	12.5"	60 seconds	up to 7 mil	31	2 year
F1	LS950	3M™ LS950	2	8.5"	–	2.5 mil	–	1 year
F2	LS1000	3M™ LS1000	2	12"	–	2.5 mil	–	1 year

Our Brand, YOUR Savings!



A OP BRAND LAMINATING POUCHES

For heat laminating systems.
9"×11½".

ORDER NUMBER	DESCRIPTION	UNIT
1 27811-50038	3 mil	50/PK
2 27811-50039	5 mil	50/PK



B FELLOWES® THERMAL LAMINATING POUCHES

Preserve, protect, & enhance important documents. Premium quality pouches ensure clear, durable results. Simple and easy to use - just place document in the right pouch size and insert into the laminator. Compatible with all laminator brands.

ORDER NUMBER	DESCRIPTION	UNIT
1 52001	Business card size, 5mil, 2¼"×3¾"	25/PK
2 52031	Business card size, 5mil, 2¼"×3¾"	100/PK
3 52033	ID Tag punched with clip, 5mil	25/PK
4 52015	ID Tag not punched, 5mil	100/PK
5 52003	Luggage tag with loop, 5mil	25/PK
6 52010	Photo card size, 5mil, 4½"×6¼"	25/PK
7 5744301	Letter size, 3 mil, 9"×11½"	50/PK
8 5743301	Letter size, 3 mil, 9"×11½"	100/PK
9 5743501	Letter size, 5 mil, 9"×11½"	100/PK
10 52226	Legal size, 3 mil, 9"×14½"	50/PK
11 52013	Menu size, 3mil, 11½"×17½"	50/PK

C FELLOWES® GLOSSY SUPERQUICK™ LAMINATING POUCHES

Preserve, protect and enhance important documents. The high quality pouches are sealed on long side for faster lamination. They provide clear, durable results. Simple and easy to use - just place document in the pouch and insert it into the laminator. Compatible with all laminator brands that have a 12.5" entry width size or wider.



ORDER NUMBER	DESCRIPTION	UNIT
1 5245801	Letter size, 3 mil, 11½"×9"	100/PK
2 5223001	Letter size, 5 mil, 11½"×9"	100/PK

D FELLOWES® IMAGELAST™ LAMINATING POUCHES

Built in UV protection prevent fading and provide superior laminate. Offers Jam Free performance when used with a Fellowes laminator. Directional arrow guidance for correct pouch insertion into laminator. Premium materials provide excellent clarity and durability. Easy to use; place document in pouch and insert into laminator. Compatible with all thermal laminator brands.



ORDER NUMBER	DESCRIPTION	UNIT
1 5200501	Letter size, 3 mil, 9"×11½"	25/PK
2 52225	Letter size, 3 mil, 9"×11½"	50/PK
3 52454	Letter size, 3 mil, 9"×11½"	100/PK

ORDER NUMBER	DESCRIPTION	UNIT
4 52040	Letter size, 5 mil, 9"×11½"	100/PK
5 5244101	Letter size, 3 mil, 9"×11½"	200/PK
6 5245301	Letter size, 5 mil, 9"×11½"	200/PK

E GBC® HEATSEAL NAP-LAM II ROLL FILM

Premium quality. Best used with all hot roll laminators.



ORDER NUMBER	DESCRIPTION	UNIT
13465-60505	1.5 mil, 25" x 500'	2/BX

F GBC® EZ LOAD™ CLEAR NAP II ROLL FILM

Designed for use with the GBC® Pinnacle 27 EZLoad™ Laminator. Front and back clear roll film. Matte finish.



ORDER NUMBER	DESCRIPTION	UNIT
1 3125365EZ	1.7 mil, 12"×300'	2/BX
2 3125913EZ	3 mil, 12"×200'	2/BX
3 3748204EZ	3 mil, Glossy, 25"×250'	2/BX
4 3000052EZ	5 mil, 12"×100'	2/BX

Binding and Laminating – laminating supplies

A GBC® FOTON®30 CARTRIDGES

Easy to load, self-threading cartridges make changing film simple and easy. Letter sized.



ORDER NUMBER	DESCRIPTION	LAMINATES/RL	UNIT
1 FOTONC003S	3 mil, standard roll	102	EA
2 FOTONC003B	3 mil, bulk roll	230	EA
3 FOTONC005S	5 mil, standard roll	90	EA
4 FOTONC005B	5 mil, bulk roll	140	EA



C GBC® FOTON® 30 RELOADABLE LAMINATING CARTRIDGES

Reduce disposable plastic volume by 77%...from 357g to 83g. Made from 65% recycled material.

ORDER NUMBER	DESCRIPTION	UNIT
1 FOTONRC003C	3 mil, 185' Cartridge & Film	EA
2 FOTONRC003	3 mil, 185' Film Refill	EA
3 FOTONRC005C	5 mil, 113' Cartridge & Film	EA
4 FOTONRC005	5 mil, 113' Film Refill	EA

E SCOTCH® SELF-LAMINATING POUCHES

Instant, permanent document laminating with no heat or machine needed. Photo-safe, acid-free pouches deliver two-sided protection in one application. Ultra-clear design lets important information show through.



ORDER NUMBER	DESCRIPTION	UNIT
LS851	For business cards	25/PK



G GEO® PROTECTIVE ADHESIVE FILM

Removable self-adhesive film - great for backing books and protecting surfaces.

ORDER NUMBER	DESCRIPTION	UNIT
1 452AC	18"×60"	EA
2 4525	18"×75'	EA



B 3M™ COOL LAMINATOR CARTRIDGES

ORDER NUMBER	DESCRIPTION	UNIT
1 DL951	8½" Front/back for LS950	EA
2 DL1001	12" Front/back for LS1000	EA

NEW!

D SCOTCH™ THERMAL DRY ERASE LAMINATING POUCHES

Protects and adds professionalism to business documents. Great for signs, flyers, schedules, certificates, to-do lists. Ultra clear photo-safe finish. Safe to use with dry erase markers, wipes off easily. 8 9/16"×11 2/5".



ORDER NUMBER	UNIT
TP3854-20DE-EF	20/PK

F GBC® EZUSE™ LAMINATING POUCHES

Visible EZUse™ features disappear after lamination. Alignment guides make centering easy. Icons clearly identify pouch thickness. Directional arrows indicate which edge to load first. UV protection prevents fading and discoloration over time.



ORDER NUMBER	DESCRIPTION	UNIT
1 33816-04331	Letter size, 5 mil	10/PK
2 33816-20051	Letter size, 3 mil	100/PK
3 33816-20052	Letter size, 5 mil	100/PK
4 33816-03222	Legal size, 5 mil	100/PK

H FELLOWES® LAMINATOR CLEANING SHEETS

For smooth, Jam-Free performance. Keeps hot roller laminators clean and efficient! Removes the roller residue left behind after lamination and extends the laminator lifespan.



ORDER NUMBER	UNIT
5320603	10/PK



A LATHEM® 7500E ELECTRONIC TIME RECORDER

Automatically calculates worked time between punches and accumulates totals on the card for up to 100 active employees or jobs. Receives its time signal from the WWVB atomic clock in Fort Collins, Colorado. Works for pay periods or set to job mode for accurate costing information. Calculates actual or rounded time and supports an automatic break deduction from daily totals. Prints in English, French and Spanish. Automatic print alignment. Auto-front / back card sensing eliminates operator mistakes and reduces time required to punch in & out. Internal lithium battery maintains the time, card totals, and program settings for up to 3 years without power. Optional rechargeable battery keeps unit fully operational for up to 24 hours in case of a power failure. One year warranty.

ORDER NUMBER	DESCRIPTION	UNIT
1 7500E	Electronic time recorder	EA
2 VIS6008	Ribbon, Purple	EA



B LATHEM® 1600E ATOMIC TIME RECORDER & DOCUMENT STAMP

Synchronizes time to the U.S. Atomic Clock; never needs resetting, keeps time during power outages, changes time automatically during Daylight Savings. Super-bright LED light for easy viewing. Records in/out times, tracks project time. Tru-Align™ option provides fast printing and perfect punch alignment (25 Tru-Align™ time cards included). Large LCD displays date, time, day of the week. Prints time, date, preset messages – choose from 18 formats and 13 preset messages: RCVD, SENT, IN, OUT, CFMD, FILED, PAID, USED, FAXED, VOID, ORIGN, APR'D, Cmpl'd. Prints time in AM/PM or 24HR format. Uses standard time cards or job cards. Choose minutes, 1/10, 1/100, or 5/100 of an hour. Compact design and small footprint mounts easily to wall or desktop. Five year memory backup; one year warranty.

ORDER NUMBER	DESCRIPTION	UNIT
1 1600E	Atomic time recorder	EA
2 E16-100	Tru-Align™ Time Cards	100/PK



C LATHEM® PC700 WEB ENABLED TIME CLOCK

A new time clock for a new work force. It's a wall mounted touch screen employee time clock that utilizes built-in WiFi or Ethernet to connect to Lathem's our PayClock Online time and attendance software. Employees use proximity badges or PIN to punch in and out and data transfers instantly to the web. Using the touch screen display, they can indicate department transfers, enter tip amounts, view their total hours and paid time off information. The PC700 with PayClock Online, offers secure anywhere, anytime editing, reporting and exporting to payroll. Requires subscription to Lathem's PayClock Online web-based software exclusively for time & attendance any place, any time. Price varies depending on number of employees, whether it's the Standard or Enterprise version, etc.

ORDER NUMBER	DESCRIPTION	UNIT
1 PC700-WEB	Time clock	EA
2 RF-BADGE	Proximity badges	15/PK



D LATHEM® 2100HD THERMAL PRINT TIME CLOCK

The 2100HD's heavy duty construction is designed to withstand harsh environments and high volume use. A large, high-contrast LCD display shows the time and date. The EZSet™ rotary knob makes it easy to customize the clock settings and select from six different print formats for printing day of week; the month and date; time in 1-12 AM/PM hours or 24 Hour format and regular minutes or hundredths of an hour. Patented direct thermal WhisperPrint™ technology eliminates ribbons for maintenance-free operation and the Tru-Align™ printing system with LED indicator ensures perfect alignment on time cards when employees make a punch.

ORDER NUMBER	DESCRIPTION	UNIT
1 2100HD	Time clock	EA
2 E8-100	Tru-Align™ Time Cards	100/PK

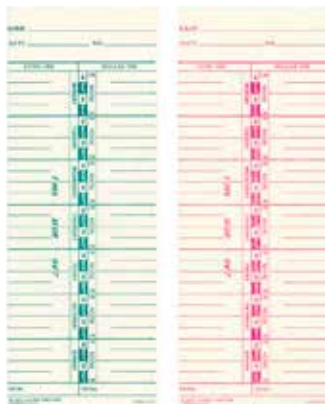

**A LATHEM®
BI-WEEKLY TIME CARDS**

Two sided time cards that are Monday to Sunday and may be used as weekly or bi-weekly. Printed red on one side and green on the other. 3½" x 9".

ORDER NUMBER	UNIT
33-2	1000/BX



**C LATHEM®
UNIVERSAL TIME CARDS**

Works with model 7500E time recorder. English. White, front printed in black, back in red; 3¼" x 8" H.

ORDER NUMBER	UNIT
E7	1000/BX



D ADAMS® TIME CARDS

Weekly time cards compatible with standard side-print time clocks. Days of week (Mon-Sun) printed on card. Left side of card is for extra time, right side of card for regular time. 3½" x 9". Bilingual.

ORDER NUMBER	UNIT
1 9351-250	250/PK
2 9351-100	100/PK



**B LATHEM®
ELECTRONIC DOCUMENT STAMP**

Features patent-pending two-line printing and fully customizable text messages to support any document stamping requirement. All print formats and custom text messages can be configured online, and programmed to the unit using a standard usb flash drive eliminating complex button setup. Configure up to four different print sets and choose which one to print on the fly with the manual buttons. 6¼"W x 7"D x 7⅞"H. Cool Grey.

ORDER NUMBER	DESCRIPTION	UNIT
1 LT5000	Stamp	EA
2 VIS6008	Purple Ribbon	EA



**E LATHEM®
EXPANDING TIME
CARD RACK**

This 25-pocket expanding time card rack conveniently holds any standard time card (up to 9" long and 4" wide). This rack expands for easy wall mounting and can be combined with others. Excess pockets can be removed to fit your company size. The durable black plastic construction resists damage and maintains an attractive appearance in even the harshest environments. Includes pocket number labels and mounting hardware.



ORDER NUMBER	UNIT
25-9EX	EA

Office Supplies

Accounting	163-168
Adhesives	239-243
Badges	139-140
Binders & Accessories	175-182
Boards	334-348
Cash Handling	324-328
Clipboards	198-199
Clocks	349
Correction Supplies	289-290
Workspace Organization	224-233
Envelopes	317-323
Fastening	234-236
Filing & Storage	200-233
Indexes	183-190
Labels	133-138
Lamps	350-352
Notebooks & Pads	153-162
Paper	124-132
Pencil Sharpeners	310-312
Calendars & Planners	141-152
Punches	266-268
Reception Desk Accessories	252-257
Report Covers	191-195
Rulers & Measuring	316
Scissors & Trimmers	313-315
Self-Adhesive Pads & Flags	244-251
Sheet Protectors	196-197
Signs & Display	329-333
Stamps	169-174
Staplers	258-265
Tape	237-238
Writing Supplies	269-309



Paper – multipurpose and copy

BRIGHTNESS: 98
WEIGHT: 20 LB



A PAPERLINE MULTIPURPOSE PAPER

The smooth surface allows sharp, clean reproduction for all documents & presentations. Check with your local dealer for availability.

ORDER NUMBER	DESCRIPTION	UNIT
1 00000-1	8½"×11"	500/PK
2 00000-8	8½"×11"	5000/CT

BRIGHTNESS: 92
WEIGHT: 20 LB



B DOMTAR® MULTIPURPOSE PAPER

Economical yet versatile for internal documents & everyday use. 100% Canadian made. SFI® certified sourcing. Elemental chlorine free & acid-free. Laser and desktop inkjet guaranteed. Check with your local dealer for availability.

ORDER NUMBER	DESCRIPTION	UNIT
1 3994	8½"×11"	500/CT
2 3995	8½"×11", 3-hole	500/PK
3 3996	8½"×14"	500/PK
4 3997	11"×17"	500/PK

OFFICE SUPPLIES



BRIGHTNESS: 92
WEIGHT: 20 LB



C DOMTAR® EARTHCHOICE® OFFICE PAPER

Sustainable. Dependable. Manufactured with ColorLok® Technology. FSC® Certified.

**BUY MORE
SAVE MORE**

ORDER NUMBER	DESCRIPTION	UNIT	1-9	10
2700	8½"×11"	500/PK		

BRIGHTNESS: 92
WEIGHT: 20 LB



D PAPERLINE MULTIPURPOSE PAPER

The smooth surface allows sharp, clean reproduction for all documents and presentations. Check with your local dealer for availability.

ORDER NUMBER	DESCRIPTION	UNIT
1 14118	8½"×11"	500/PK
2 14128	8½"×11"	5000/CT
3 14197	8½"×14"	500/PK
4 14198	8½"×14"	5000/CT
5 14199	11"×17"	500/PK
6 14200	11"×17"	2500/CT

NEW!

BRIGHTNESS: 94
WEIGHT: 20 LB



E DOMTAR® EARTHCHOICE® 30 OFFICE PAPER

Features ColorLok® Technology for bolder blacks and vivid colours with inkjet printing and better quality performance with laser printing. Contains a minimum of 30% post-consumer recycled content. FSC® Certified. 88% Opaque. Smoothness: 160. 4.0 mil. White.

ORDER NUMBER	DESCRIPTION	UNIT
1842	8½"×11"	500/PK

BRIGHTNESS: 92
WEIGHT: 20 LB



F ROLLAND ENVIRO™ 100 COPY PAPER

Made from 100% post-consumer recycled materials; FSC® Certified. Acid free. 20 lb, 3.8 mil, 500 sheets per package.

**BUY MORE
SAVE MORE**

ORDER NUMBER	DESCRIPTION	UNIT	1-9	10
1 5101	8½"×11"	500/PK		
2 5103	8½"×14"	500/PK		

BRIGHTNESS: 92
WEIGHT: 20 LB



A HAMMERMILL® TIDAL® MULTIPURPOSE PAPER

Dependable performance at a reasonable cost. For inkjet and laser printers, faxes and copiers. 99.99% jam free. SFI® Certified.

ORDER NUMBER	DESCRIPTION	UNIT
16200-8	8½"×11"	500/PK



BRIGHTNESS: 92
WEIGHT: 20 LB



B DOMTAR LETTERMARK™ COPY PAPER

The same great paper from Domtar, delivering exceptional everyday performance. Features ColorLok® Technology. SFI® Certified. 92 Bright. 88% opaque. Smoothness: 160. 4.0 mil. 8½"×11". White.

ORDER NUMBER	DESCRIPTION	UNIT
4023-SPI	8½"×11"	1500/CT

BRIGHTNESS: 92
WEIGHT: 20 LB



C HAMMERMILL® A4 PAPER

An economical product that's perfect for everyday printing and copying. This versatile paper is great for all types of black and white documents, copies and printouts. FSC® Certified. 99.99% Jam-free.

ORDER NUMBER	DESCRIPTION	UNIT
105500	8½"×11¾"	500/PK

BRIGHTNESS: 100
WEIGHT: 28-32 LB



D HAMMERMILL® PREMIUM COLOR COPY PAPER

Combines an extra smooth surface and high brightness white to produce exceptional colour images. Heavyweight. FSC® Certified. 99.99% Jam-free.

ORDER NUMBER	DESCRIPTION	UNIT
1 10246-7	8½"×11", 28 lb.	500/PK
2 10254-1	11"×17", 28 lb.	500/PK
3 10263-0	8½"×11", 32 lb.	500/PK



BRIGHTNESS: 96
WEIGHT: 20-24 LB



E HAMMERMILL® FORE™ MULTIPURPOSE PAPER

Perfect for copies, newsletters, flyers and double-sided printing. FSC® Certified. 90% opaque. Smoothness: 135. White.

ORDER NUMBER	DESCRIPTION	UNIT	1-9	10
1 10326-7	8½"×11", 20 lb.	500/PK		
2 10328-3	8½"×11", 24 lb.	500/PK		

**BUY MORE
SAVE MORE**

BRIGHTNESS: 98
WEIGHT: 24 LB



F HAMMERMILL® PREMIUM LASER PRINT PAPER

Bright, with ultra smooth surface for crisp text, high resolution images and great contrast. FSC® Certified. 99.99% Jam-free.

ORDER NUMBER	DESCRIPTION	UNIT
10460-4	8½"×11"	500/PK

Paper – coloured and cover stock

BRIGHTNESS: 100
WEIGHT: 60-100 LB



A HAMMERMILL® PREMIUM COLOR COPY COVER

Premium heavyweight 60 lb, 80 lb and 100 lb cover and card paper. Ideal for presentation covers, invitations and business cards. FSC® Certified; 8½"×11".

ORDER NUMBER	DESCRIPTION	UNIT
1 12254-9	White, 60 lb.	250/PK
2 12002-3	White, 80 lb.	250/PK
3 12002-4	White, 100 lb.	250/PK

WEIGHT: 67 LB



B SPRINGHILL® VELLUM BRISTOL COVER

For laser and inkjet printers and copiers. For attractive cover pages of any type, menus, posters and certificates; 8½"×11". Colours: **BLU** Blue, **CAN** Canary, **CRE** Cream, **GRE** Green, **PIN** Pink.

ORDER NUMBER	DESCRIPTION	UNIT
1 SPRV921952	White, 92 Bright	250/PK
2 SPRV__1952	Specify colour	250/PK

BRIGHTNESS: 92
WEIGHT: 110 LB



C SPRINGHILL® DIGITAL INDEX CARD STOCK

Guaranteed to run on small and large offset presses, digital imaging equipment, including copiers, laser and inkjet printers, as well as plain-paper fax machines that accept higher basis weight papers. 8½"×11".

ORDER NUMBER	DESCRIPTION	UNIT
15300	White	250/PK

WEIGHT: 65 LB

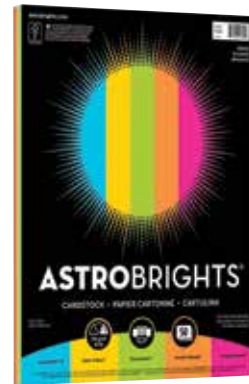

D NEENAH® COVER STOCK

FSC® Certified. 8½"×11". 65 lb. Assortment consists of 10 sheets each of: Solar Yellow, Cosmic Orange, Fireball Fuchsia, Terra Green and Lunar Blue.

ORDER NUMBER	DESCRIPTION	UNIT
1 91904	White, 96 Bright	250/PK
2 99326	Bright colour assortment	50/PK

WEIGHT: 20 LB



E HAMMERMILL® MP COLOURS PAPER

Standard weight 20 lb paper. 30% post-consumer recycled fibre. Colours: **BLU** Blue, **CAN** Canary, **CRE** Cream, **GOL** Goldenrod, **GRA** Grey, **GRE** Green, **PIN** Pink, **SAL** Salmon.

**BUY MORE
SAVE MORE**

ORDER NUMBER	DESCRIPTION	UNIT	1-9	10
1 FORMP__10FSC	8½"×11", specify colour	500/PK		
2 FORMP__1272FSC	8½"×14", specify colour: BLU, CAN, GRE, GOL, PIN only	500/PK		

WEIGHT: 24 LB



F NEENAH® ASTROBRIGHTS® PAPER

Bright colours for use in inkjet and laser printers. Heavyweight. Colours: **CCO** Cosmic orange, **GAG** Gamma green, **LFL** Lift-off lemon, **LRB** Lunar blue, **PRP** Pulsar pink, **RYR** Re-entry red, **SRY** Solar yellow, **VNG** Vulcan green.

ORDER NUMBER	DESCRIPTION	UNIT
AST__118FSC	8½"×11", specify colour	500/PK

WEIGHT: 24 LB

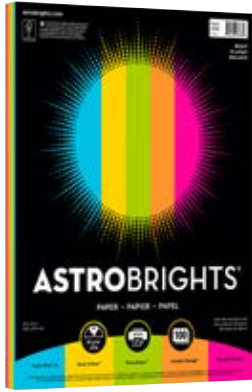

A NEENAH® ASTROBRIGHTS® PAPER

Contains a minimum of 30% post-consumer recycled material. FSC® Certified. 8½"×11". 24 lb. Colours: Terrestrial Teal, Cosmic Orange, Planetary Purple, Fireball Fuchsia and Solar Yellow.

ORDER NUMBER	DESCRIPTION	UNIT
98768	5-colour assortment	100/PK

WEIGHT: 20 LB

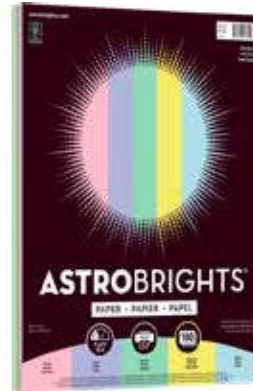

B NEENAH® ASTROBRIGHTS® PASTEL PAPER

Assortment consists of 35 sheets each of: Pink, Lilac, Green, Yellow and Blue. 30% post-consumer recycled fibre.

ORDER NUMBER	DESCRIPTION	UNIT
91725	5-colour assortment	100/PK

C REVOLUTION™ NEVER TEAR PAPER

This synthetic paper made from a polyester film is tear, water and chemical resistant. It is an ideal choice for tough applications and heavy use. 5.0 mil.



ORDER NUMBER	DESCRIPTION	UNIT
3R20172	8½"×11"	100/PK

BRIGHTNESS: 110
WEIGHT: 21 LB

D HP® LARGE FORMAT UNIVERSAL BOND PAPER

A low cost paper that's perfect for black and white and colour line drawings. Universally compatible with HP DesignJet printers and non-HP large format printers. ColorPRO technology produces more striking colours, crisper text and graphics, and higher contrast blacks for professional quality results at production speed. Continuous roll format; 110 brightness, 21 lb.



ORDER NUMBER	DESCRIPTION	UNIT
1 Q1396A	Universal bond, 24"×150'	EA
2 Q1397A	Universal bond, 36"×150'	EA
3 Q1398A	Universal bond, 42"×150'	EA



BRIGHTNESS: 95
WEIGHT: 24 LB

E HP® LARGE FORMAT BRIGHT WHITE INKJET PAPER

ColorPRO technology produces more striking colours, crisper text and graphics, and higher contrast blacks for professional quality results at production speed. Continuous roll format.

ORDER NUMBER	DESCRIPTION	UNIT
C1861A	36"×500', inkjet	EA



BRIGHTNESS: 92
WEIGHT: 20 LB

F DTEC® REPROGRAPHIC BOND WIDE FORMAT PAPER

Consistent quality for drafting paper products. Crisp reproduction.

ORDER NUMBER	DESCRIPTION	UNIT
UNTAPED		
1 DTECB0098	2" Core, 24"×150'	RL
2 DTECB0099	2" Core, 36"×150'	RL
3 DTECB0096	3" Core, 24"×500'	RL
4 DTECB0097	3" Core, 36"×500'	RL
TAPED		
5 DTECB0012	3" Core, 36"×500',	RL



BRIGHTNESS: 91
WEIGHT: 26 LB

G DTEC® AQ WIDE FORMAT PRESENTATION PAPER

Impressive performance-to-cost value for graphic arts and prepress applications. High opacity and optimal colour gamut. Fast dry time and easy lamination. Matte finish.

ORDER NUMBER	DESCRIPTION	UNIT
1 DTECMPP98241502	2" Core, 24"×150' RL	
2 DTECMPP98361502	2" Core, 36"×150' RL	

Paper – photo and presentation



WEIGHT: 66 LB

A HP® ADVANCED PHOTO PAPER

Glossy finish photo paper provides instant dry photos on any inkjet printer; 66 lb bond.

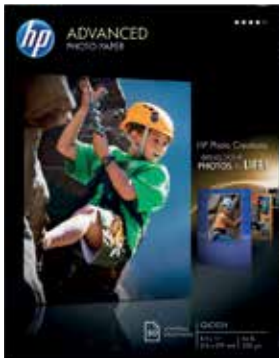

WEIGHT: 48 LB

B KODAK PICTURE PAPER

Works on all inkjet printers. Great everyday value for printing. 48lb. 6.5 mil.



ORDER NUMBER	DESCRIPTION	UNIT
1 Q6638A	4"×6"	100/PK
2 Q7853A	8½"×11"	50/PK

ORDER NUMBER	DESCRIPTION	UNIT
GLOSSY		
1 9891-161	4"×6"	100/PK
2 9891-158	8½"×11"	25/PK
3 9891-159	8½"×11"	50/PK
4 9891-160	8½"×11"	100/PK
MATTE		
5 3510-218	8½"×11"	50/PK

WEIGHT: 75 LB

C HP® PREMIUM PLUS GLOSSY PHOTO PAPER

HP's thickest, heaviest and best all-around photo paper maximizes colour intensity with a professional-quality glossy finish, rendering realistic skin tones, and resists fading for generations. For inkjet printers. 75 lb.



BRIGHTNESS: 90
WEIGHT: 27 LB

D EPSON® PRESENTATION PAPER

Ideal for printing newsletters, flyers, reports or special presentations containing photos or graphics. Matte. 90 Bright. 27 lb. 4.9 mil.



ORDER NUMBER	DESCRIPTION	UNIT
1 CR669A	5"×7"	60/PK
2 CR664A	8½"×11"	50/PK

ORDER NUMBER	DESCRIPTION	UNIT
S041062	8½"×11"	100/PK

WEIGHT: 53 LB

E HP® EVERYDAY INKJET PHOTO PAPER

Print colourful photo projects you can enjoy straight off the printer.



BRIGHTNESS: 97
WEIGHT: 44 LB

F EPSON® PREMIUM PRESENTATION PAPER

Heavyweight, non-glare card stock for school and business projects. Great for photos. Matte.



ORDER NO.	DESCRIPTION	UNIT
Q8723A	8½"×11"	50/PK

ORDER NUMBER	DESCRIPTION	UNIT
S041257	8½"×11"	50/PK

BRIGHTNESS: 89
WEIGHT: 52 LB

G EPSON® PHOTO QUALITY GLOSSY INKJET PAPER

52lb. 89 Bright. True photographic images with vivid, high-quality colour.



WEIGHT: 45-70 LB

H CANON® INKJET PHOTO PAPER

ORDER NUMBER	DESCRIPTION	UNIT
1 1432C005	4"×6", glossy finish, 70 lb.	50/PK
2 7981A004	8½"×11", matte finish, 45 lb.	50/PK





A GRANITE BOND™ PREMIUM LETTERHEAD PAPER

The look of granite gives this premium paper a lasting impression of strength and permanence. For résumés, business stationery and reports. Inkjet/laser, FSC® Certified, contains 30% post-consumer material; 24 lb.

ORDER NUMBER	DESCRIPTION	UNIT
1 57246-78812	8½"×11", Grey	100/PK
2 57246-78813	8½"×11", Ivory	100/PK
3 57246-78302	8½"×11", Grey	400/PK
4 57246-78303	8½"×11", Ivory	400/PK



B QUALITY PARK® A2 INVITATION ENVELOPES

Designed to hold an 8½"×11" sheet of paper folded in quarters. Features side seamed gummed flap construction.

ORDER NUMBER	UNIT
QUA36217	100/BX



C ANTIQUE BOND™ PARCHMENT PAPER

Subtle and elegant with the classic look of parchment. Ideal for letterheads, reports, invitations and résumés. Inkjet/laser, FSC® Certified, contains 30% post-consumer material; 24 lb. Colours: **2** Grey, **3** Natural, **4** White, **6** Blue, **8** Aged.

ORDER NUMBER	DESCRIPTION	UNIT
1 57246-7872	8½"×11", specify colour	100/PK
2 57246-78223	8½"×11", natural	400/PK



Notecard 4¼"×5½"

Placecard 4¼"×1¾"



D OVERTURES® INVITATIONS AND CARDS

Ready to print cards are perfect for creating personalized stationery for business and personal events. Traditional embossing; scored and/or micro-perforated for easy folding and separation after printing. Green seal certified; 47 lb. bond, 30% post-consumer content. Laser and inkjet compatible. Download free MS Word templates from www.stjamespublishing.com.

ORDER NUMBER	DESCRIPTION	UNIT
1 57246-71020	Note cards, White	40/PK
2 57246-71021	Note cards, Ivory	40/PK
3 57246-71413	Place cards, White	60/PK
4 57246-71414	Place cards, Ivory	60/PK



E ST. JAMES RÉSUMÉ BOND™

Watermarked paper is 25% cotton. Contains a minimum of 30% post-consumer recycled material. FSC® certified. Laser and inkjet compatible. 24lb.

ORDER NUMBER	DESCRIPTION	UNIT
57246-76500	8½"×11", white	100/PK



Paper – certificates and holders



A ST. JAMES® ELITE GOLD FOIL CERTIFICATES

Leave a lasting impression with these gold foil stamped certificates. FSC® Certified ivory linen 24 lb paper; contains 30% post-consumer material. Acid free and lignin free; laser and inkjet compatible; 8½"×11". Download templates at www.stjamespublishing.com.

ORDER NUMBER	DESCRIPTION	UNIT
57246-83429	Deco	12/PK



C ST. JAMES® ELITE MEDALLION FOLD LINEN CERTIFICATE HOLDER

Create excitement when presenting awards with this unique double fold certificate holder. Acid and lignin free 80 lb linen stock. FSC® Certified, contains 30% post consumer material. Folded size: 9¾"×12½"; holds 8½"×11" documents.

ORDER NUMBER	DESCRIPTION	UNIT
1 57246-83536	Navy with silver embossing	5/PK
2 57246-83534	Navy with gold medallion	5/PK
3 57246-83566	Black with silver medallion	5/PK



D ST. JAMES® CERTIFICATE PRESENTATION CARDS

A low-cost solution to presenting an award. Holds 8½"×11" documents FSC® certified. 80lb. linen cover. 9¾"×12½".

ORDER NUMBER	DESCRIPTION	UNIT
57246-83480	Navy	25/PK

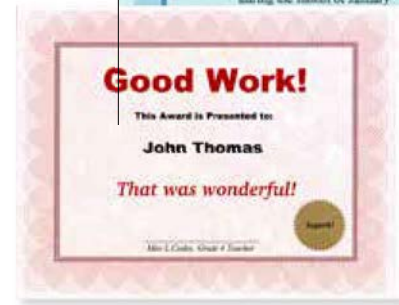

B ST. JAMES® REGENT CERTIFICATES

Laser and inkjet compatible, acid and lignin free. FSC® Certified, contains 30% post-consumer material. 8½"×11", 24 lb. Security imprint on reverse prevents copying or duplication. Download free MS Word templates from www.stjamespublishing.com.

ORDER NUMBER	DESCRIPTION	UNIT
1 57246-83402	Blue with seals	25/PK
2 57246-83409	Red with seals	25/PK
3 57246-83500	Blue, no seals	100/PK
4 57246-83502	Red, no seals	100/PK



83434



83464



E ST. JAMES® CERTIFICATE HOLDERS

Linen holders with classic gold foil stamping. FSC® Certified 80 lb. stock, contains 30% post consumer material. Folded size: 9¾"×12½"; holds 8½"×11" documents. Classic colours: **34** Navy, **64** Black.

ORDER NUMBER	DESCRIPTION	UNIT
57246-834__	Classic, specify colour	5/PK



A ST. JAMES® FLOATING AWARD AND RECOGNITION CERTIFICATE FRAME

For 8½"×11" certificates or documents.

ORDER NUMBER	DESCRIPTION	UNIT
57246-83914	Black, 15"×12"	EA



B ST. JAMES® AWARD & RECOGNITION CERTIFICATE FRAME

White outer matte, black inner matte. Easy insert backdoor system for easy, accurate loading of certificate. Fits all letter size documents, can be hung in either portrait or landscape orientation. Frame contains 100% recycled material.

ORDER NUMBER	DESCRIPTION	UNIT
57246-83910	Tuxedo black, 16¼"×14¼"	EA



C ST. JAMES® FRAME

For 11×8 ½" certificates, awards and photos. Wall display horizontally or vertically. Anti-scratch glass cover. Molding made from 30% recycled material.

ORDER NUMBER	DESCRIPTION	UNIT
57246-83902	Tuscan Black with Gold Trim	EA



D ST. JAMES® AWARD & RECOGNITION CERTIFICATE FRAMES

For 11×8 ½" certificates, awards and photos. Molding made from 30% recycled material. Includes an easel-back for displaying on table top as well as hooks for hanging on the wall. Display horizontally or vertically. Anti-scratch glass cover.

ORDER NUMBER	DESCRIPTION	UNIT
1 57246-83903	Tuscan Cherry with Gold Trim	EA
2 57246-83904	Milano Glossy Black	EA



E ST. JAMES® GIFT CERTIFICATES

Perfect for corporate functions, giveaways, etc. Regent blue and silver certificate. Contains 30% post-consumer material; FSC® Certified. Go to www.stjamespublishing.com for templates.

ORDER NUMBER	DESCRIPTION	UNIT
57246-83403	8½"×3½"	75/PK



F ST. JAMES® IMPRINTABLE CERTIFICATE SEALS

Add a personalized gold seal to an award to transform it into a treasured keepsake. Laser and inkjet imprintable, 1¾" diameter. Free downloadable templates available at www.stjamespublishing.com.

ORDER NUMBER	DESCRIPTION	UNIT
57246-83430	Gold	200/PK



G AVERY® LEGAL SEALS

Self-adhesive, permanent seals; 1½" diameter.

ORDER NUMBER	DESCRIPTION	UNIT
1 67933-02353	Gold	60/PK
2 67933-02354	Red	60/PK

A AVERY® TICKETS WITH TEAR-AWAY STUBS

Perfect for raffles, dances, door prizes, company events. 65lb. card stock. Free templates include sequential ticket numbering. Printable both sides on laser or inkjet. Strong perforations on stubs. 10/sheet. White.



ORDER NUMBER	DESCRIPTION	UNIT
67933-16154	1¾"×5½"	200/PK

B AVERY® PRINT-TO-THE-EDGE TAGS WITH STRINGS

Includes pre-punched holes and premium-style fabric string with a quick-latch fastener for easy and secure attachment. Laser and inkjet compatible. White.



ORDER NUMBER	DESCRIPTION	UNIT
1 67933-22858	2"×3½"	80/PK
2 67933-22857	2" round	120/PK

C AVERY® WHITE TENT CARDS

Ideal for meetings, presentations, seminars and conferences. Embossed for a professional appearance and pre-scored for neat folding. Sure Feed™ allows precision printing; prevents skewing and misfeeds of label sheets for accurate print alignment. Laser and ink jet compatible. 65lbs.



ORDER NUMBER	DESCRIPTION	UNIT
1 67933-05305	2½"×8½"	100/BX
2 67933-05309	3½"×11"	50/BX

D AVERY® GREETING CARDS

Create customized greeting cards for every occasion with personalized messages, designs and photos. Includes envelopes. 85lb. White.



ORDER NUMBER	DESCRIPTION	UNIT
67933-03265	5½"×8½"	20/BX

E AVERY® GREETING CARDS

The premium, heavyweight card stock provides an excellent base for vivid graphics and sharp, clear text. For inkjet printers. 85lb. White.

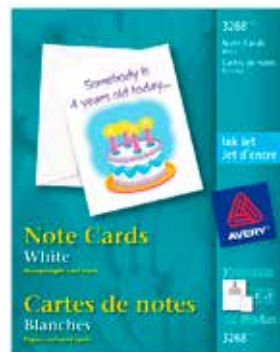

ORDER NUMBER	DESCRIPTION	UNIT
67933-03268	4¼"×5½"	30/BX

F AVERY® MAGNETIC SHEETS

Letter size white, printable magnetic sheet. Use your inkjet printer to create business cards, custom designs and more. Easily cut out with scissors. 8½"×11". Inkjet only.



ORDER NUMBER	DESCRIPTION	UNIT
67933-03270	White	5/PK

G AVERY® IRON-ON TRANSFERS

Create custom T-shirts, aprons, gift bags, mouse pads, photographs on quilts and more. Designed for vivid results on cotton or cotton/poly blend fabrics. 8½"×11". Inkjet only.



ORDER NUMBER	DESCRIPTION	UNIT
1 67933-03275	For white/ light fabrics	12/PK
2 67933-03302	For white/light stretchable fabrics	5/PK
3 67933-03279	For dark fabrics	5/PK



Avery Labels with Sure Feed™ Technology

Designed for reliable printer feed every time!

- ✓ Accurate Print Alignment
- ✓ Fewer Printer Jams
- ✓ No Wasted Labels
- ✓ Free templates available on avery.ca

Textured leading edge.



Paper – labels



A AVERY® WHITE ADDRESS LABELS

Bright white, high-quality permanent labels provide crisp, clear print and trouble-free printing. Jam and smudge free. Sure Feed™ prevents skewing and misfeeds of label sheets for accurate print alignment. Asterisk (*) denotes labels with EasyPeel® feature. Laser and inkjet compatible.

ORDER NUMBER	DESCRIPTION	UNIT
250 SHEETS		
1 67933-05960*	1"×2½"	7500/BX
100 SHEETS		
2 67933-05167*	½"×1¾"	8000/BX
3 67933-05160*	1"×2½"	3000/BX
4 67933-05161*	1"×4"	2000/BX
5 67933-05159	1½"×4"	1400/BX
6 67933-05162*	1½"×4"	1400/BX
25 SHEETS		
7 67933-05267*	½"×1¾"	2000/PK
8 67933-05195*	1¾"×2½"	1500/PK
9 67933-05260*	1"×2½"	750/PK
10 67933-05261*	1"×4"	500/PK
11 67933-05259	1½"×4"	350/PK
12 67933-05262*	1½"×4"	350/PK
10 SHEETS		
13 67933-08995*	¾"×1¾"	600/PK



C AVERY® ECOFRIENDLY MAILING LABELS

Made from 100% recycled material (100% post-consumer), with a water-based 100% recyclable adhesive. Processed chlorine free; packaging printed using soy based ink. Laser and inkjet compatible.

ORDER NUMBER	DESCRIPTION	UNIT
1 67933-48160	1"×2½"	750/PK
2 67933-48860	1"×2½"	300/PK
3 67933-48163	2"×4"	1000/BX
4 67933-48863	2"×4"	100/PK
5 67933-48460	1"×2½"	3000/BX
6 67933-48464	3½"×4"	600/BX
7 67933-48867	½"×1¾"	800/PK



B OP BRAND MAILING LABELS

Jam resistant permanent labels. Laser and inkjet compatible. 100 sheets per box.

ORDER NUMBER	DESCRIPTION	UNIT
1 27811-30002	8½"×11"	100/BX
2 27811-30004	4"×1"	2000/BX
3 27811-30005	2½"×1"	3000/BX
4 27811-30006	4"×2"	1000/BX
5 27811-30007	4"×3½"	600/BX

Templates	
OPB30005	= Avery 05160
OPB30004	= Avery 05161
OPB30006	= Avery 05163
OPB30007	= Avery 05164
OPB30002	= Avery 05165

Our Brand, YOUR Savings!



D PRES-A-PLY® MAILING LABELS

Economical paper labels for laser and inkjet printers.

ORDER NUMBER	DESCRIPTION	UNIT
1 67933-30600	1"×2½"	3000/BX
2 67933-30602	1½"×4"	1400/BX
3 67933-30603	2"×4"	1000/BX
4 67933-30605	8½"×11"	100/BX



A AVERY® CLEAR GLOSSY SHIPPING & ADDRESS LABELS

Pop-Up Edge™ feature exposes grab area for faster peeling & more intuitive motion (except 8 1/2"×11"). Labels virtually disappear on white and coloured envelopes. Clear labels make addresses look more professional. Guaranteed printer performance and easy formatting solutions. Customize with free templates and software from avery.ca/print. Laser and inkjet compatible.

ORDER NUMBER	DESCRIPTION	UNIT
1 67933-07665	8 1/2"×11"	10/PK
2 67933-07664	3 1/2"×4"	60/PK
3 67933-07671	NEW! 3"×3"	60/PK
4 67933-07663	2"×4"	100/PK
5 67933-07662	1 1/2"×4"	140/PK
6 67933-07670	NEW! 1 1/2"×1 1/2"	240/PK
7 67933-07661	1"×4"	200/PK
8 67933-07660	1"×2 3/8"	750/PK
9 67933-07666	1"×2 3/8"	300/PK
10 67933-07669	NEW! 1" Diameter	480/PK
11 67933-07668	3/8"×1 3/4"	600/PK
12 67933-07667	1/2"×1 3/4"	800/PK



D AVERY® TRUEBLOCK™ WHITE SHIPPING LABELS

TrueBlock™ technology completely covers everything underneath. Bright white for professional results. Permanent. Laser and inkjet compatible.

ORDER NUMBER	DESCRIPTION	UNIT
250 SHEETS		
1 67933-05963	2"×4"	2500/BX
100 SHEETS		
2 67933-05163	2"×4"	1000/BX
3 67933-05164	3 1/2"×4"	600/BX
4 67933-05168	5"×3 1/2"	400/BX
5 67933-05126	5 1/2"×8 1/2"	200/BX
6 67933-05165	8 1/2"×11"	100/BX
25 SHEETS		
7 67933-05263	2"×4"	250/PK
8 67933-05264	3 1/2"×4"	150/PK
9 67933-08126	5 1/2"×8 1/2"	50/PK
10 67933-05265	8 1/2"×11"	25/PK

Check online for the most current price.



B AVERY® MAILING LABELS FOR COPIERS

Create a master sheet to produce multiple labels in one session. Customize with free tools, software and templates from www.avery.ca.



ORDER NUMBER	DESCRIPTION	UNIT
1 67933-45004	2 3/16"×1"	3300/BX
2 67933-45008	2 3/16"×1 1/2"	2100/BX
3 67933-45005	4 1/4"×2"	1000/BX

C INDUSTRIAL THERMAL LABELS

Ideal for shipping labels, bar codes, ID labels, price labels and tags. Perforated for easy application to cartons and skids. 4"×6". White. 1000 labels/roll.



ORDER NUMBER	DESCRIPTION	UNIT
1 3420025D	Direct Thermal, fits most direct transfer printers	RL
2 THETL46WR	Thermal Transfer, fits most thermal transfer ribbon printers	RL



E AVERY® WHITE SHIPPING LABELS

Versatile and economical option for high volume, low-cost printing. Ideal for shipping labels and identification needs. Permanent. Laser and inkjet compatible. White.

ORDER NUMBER	DESCRIPTION	UNIT
1 67933-35163	2"×4"	2500/PK
2 67933-35164	3 1/2"×4"	1500/PK
3 67933-35126	5 1/2"×8 1/2"	500/PK



A AVEREY® I.D. LABELS

Acid-free and archival-safe. Larger size (#06573) is ideal where storage and signage labels are needed.

ORDER NUMBER	DESCRIPTION	UNIT
LASER / INKJET - PERMANENT		
1 67933-06573	8½"×5"	30/PK
LASER / INKJET - REMOVABLE		
2 67933-06504	1¾"×½"	800/PK
3 67933-06498	2¾"×1"	300/PK
4 67933-06468	4"×2"	120/PK
5 67933-06499	4"×3½"	60/PK
6 67933-06502	5½"×8½"	20/PK
7 67933-06503	8½"×11"	10/PK

B AVEREY® REMOVABLE HIGH VISIBILITY NEON LABELS

Removable, reusable labels guaranteed to stick, stay and remove cleanly without leaving residue. Attention grabbing colours make messages stand out; great for organizing, colour coding, etc. Laser and inkjet compatible.

ORDER NUMBER	DESCRIPTION	UNIT
1 67933-06476	2¾"×1"	240/PK
2 67933-06477	4"×2"	80/PK



C AVEREY® DURABLE LASER LABELS

Sturdy permanent polyester labels resist moisture, scuffing, tearing and smudging. TrueBlock™ label technology completely covers everything underneath. For identifying asset property, container contents or inventory, safety warnings or instructions.

ORDER NUMBER	DESCRIPTION	UNIT
1 67933-06575	8½"×11"	50/BX
2 67933-06576	1¾"×1¼"	1600/BX
3 67933-06578	2¾"×2"	750/BX
4 67933-06579	8½"×5"	100/BX

D AVEREY® DOT MATRIX MAILING LABELS

One across labels for use with dot matrix printers.



ORDER NUMBER	DESCRIPTION	UNIT
67933-04014	4"×1½"	5000/BX



E AVEREY® HIGH VISIBILITY NEON LABELS

Ideal for priority messages, addressing, colour-coding, identification, warning labels and more. Permanent adhesive. Laser and inkjet compatible.

ORDER NUMBER	DESCRIPTION	UNIT
1 67933-05973	2"×4", Assorted	150/PK
2 67933-05970	1"×2½", Magenta	750/PK
3 67933-05971	1"×2½", Green	750/PK
4 67933-05972	1"×2½", Yellow	750/PK
5 67933-05979	1"×2½", Assorted	450/PK
6 67933-05938	8½"×11", Yellow	25/PK
7 67933-05939	8½"×11", Red	25/PK
8 67933-05933	8½"×11", Green	25/PK
9 67933-05936	8½"×11", Magenta	25/PK

F AVEREY® ULTRADUTY™ GHS CHEMICAL LABELS

Laser printer compatible. Multipurpose usage for GHS classifying and labeling chemicals as well as other applications such as OSHA safety signs, arc flash, tank, marine and outdoor workplace labels. GHS Compliant and holds up to harsh conditions such as; chemicals, abrasion, UV, water, tearing, and extreme temperatures. Sticks to most surfaces including metal, plastic, painted surfaces, fiber, polycarbonate, glass and more. With strong marine-grade adhesive, they pass the B55609 protocol for 90-day seawater immersion. White.



ORDER NUMBER	DESCRIPTION	UNIT
1 67933-60501	8½"×11"	50/PK
2 67933-60502	4¾"×7¾"	100/PK
3 67933-60503	3½"×5"	200/PK
4 67933-60504	4"×4"	200/PK
5 67933-60505	2"×4"	500/PK
6 67933-60506	2"×2"	600/PK





A AVERY® PRINT-TO-THE-EDGE LABELS

Build your business by creating your own unique and branding materials with Avery branding and merchandising solutions. A wide range of labels in a variety of shapes and finishes to brand everything.

ORDER NUMBER	DESCRIPTION	UNIT
LASER / INKJET		
1 67933-22811	Arched Wine 4¾"×3½"	40/PK
2 67933-24487	Oval 1½"×2½" Brown Kraft	180/PK
3 67933-22834	Oval 1½"×2½" Glossy Clear	144/PK
4 67933-22804	Oval 1½"×2½" Glossy White	180/PK
5 67933-24489	Oval 3"×4" Glossy White	40/PK
6 67933-22822	Rectangular 2"×3" Glossy Clear	80/PK
7 67933-22823	Rectangular 3"×3¾" Pearlezed Ivory	48/PK
8 67933-22841	Rectangular 3½"×4¾" Hemp	40/PK
9 67933-22827	Rectangular 4¾"×3½" White	32/PK
10 67933-22815	Round 2" Glossy Clear	96/PK
11 67933-22807	Round 2" Glossy White	120/PK
12 67933-22859	Round 2" Matte White	120/PK
13 67933-22808	Round 2½" Kraft Brown	225/PK
14 67933-22830	Round 2½" White	90/PK
15 67933-22842	Round 2½" Hemp	90/PK
16 67933-22813	Round 3" Kraft Brown	90/PK
17 67933-22805	Square 1½"×1½" White	600/PK
18 67933-22833	Square 2"×2" Glossy White	120/PK
19 67933-22806	Square 2"×2" White	300/PK
20 67933-22845	Wraparound 9¾"×1¼"	40/PK
21 67933-22832	Lid Seal 1½"×4" Beige NEW!	80/PK
INKJET		
22 67933-22839	Rectangular Labels 1½"×4" Gold	70/PK
23 67933-22824	Round 2" Embossed Silver Foil	96/PK



B AVERY® DISSOLVABLE PRINT-TO-THE-EDGE LABELS

Quickly dissolves with water by hand or in the dishwasher. No soaking required. Leaves no residue. Durable for long term storage, freezer safe. White.

ORDER NUMBER	DESCRIPTION	UNIT
1 67933-22205	2" dia. round	60/PK
2 67933-22206	1½"×2½", oval	90/PK



C AVERY® NO-IRON FABRIC LABELS

Make sure clothing always gets returned to its rightful owner with these no-iron clothing labels. They're great for jackets, school uniforms, baby clothes, blankets and backpacks. White.

ORDER NUMBER	DESCRIPTION	UNIT
67933-02375	½"×1¾"	72/PK



Paper – labels



A AVERY® PRINT-TO-THE-EDGE CLING-ON LABELS

Made of durable, tear-resistant film, they are an excellent choice for window graphics, salon and retail mirrors, point-of-purchase displays and much more. Removable. Laser compatible.

ORDER NUMBER	DESCRIPTION	UNIT
1	67933-22844 8½"×11" White	8/PK
2	67933-22843 8½"×11" Clear	8/PK



B AVERY® PRINT-TO-THE-EDGE VINYL SIGNS

These durable vinyl decals allow for smudge and fade resistant prints, print-to-the-edge results while standing up to water and wear. An excellent choice for indoor and outdoor application. Removable. Laser compatible.

ORDER NUMBER	DESCRIPTION	UNIT
1	67933-22852 5" Round White	16/PK
2	67933-22851 8"×10½" White	8/PK



C AVERY® SMALL ROUND LABELS

Colour optimized, permanent, for inkjet printers. Make a small message stand out.

ORDER NUMBER	DESCRIPTION	UNIT
67933-08293	1½" diameter	400/PK

D AVERY® SELF-ADHESIVE REMOVABLE WHITE LABELS

Removable multi-purpose, self-adhesive labels, handwritten or for laser and inkjet printers.



ORDER NUMBER	DESCRIPTION	UNIT
--------------	-------------	------

LASER AND INKJET PRINTERS

1	67933-02311 ½"×¾"	540/PK
2	67933-02312 ½"×1¾"	400/PK
3	67933-02313 ¾"×1"	400/PK
4	67933-02314 1"×3"	125/PK
5	67933-02315 3"×2"	75/PK
6	67933-02316 4"×2"	50/PK
7	67933-02317 6"×4"	15/PK
8	67933-02309 ¾", round	480/PK

HAND OR TYPEWRITTEN

9	67933-02310 ¾"×5/8"	720/PK
---	---------------------	--------

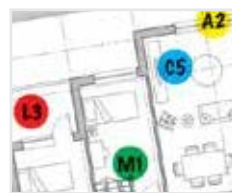

E AVERY® SEE THRU COLOUR CODING LABELS

Add a splash of colour to documents, products and more to help get organized and call out important information. Removable. Assorted colours.

ORDER NUMBER	DESCRIPTION	UNIT
1	67933-02370 ¼" diameter	648/PK
2	67933-02369 ¾" diameter	210/PK



F AVERY® REMOVABLE COLOUR CODING LABELS

Round coloured labels that help keep files organized.



ORDER NUMBER	DESCRIPTION	UNIT
--------------	-------------	------

½" ROUND

1	67933-02397 Red	420/PK
2	67933-02398 Green	420/PK
3	67933-02399 Yellow	420/PK

¼" ROUND

4	67933-02395 Blue	768/PK
5	67933-02396 Yellow	768/PK
6	67933-02394 Green	768/PK
7	67933-02335 Red	768/PK
8	67933-02339 Assorted colours	768/PK

G AVERY® PRINT OR WRITE REMOVABLE COLOUR CODING LABELS

Ideal for document and inventory control, routing, organizing, high-lighting, price marking, scheduling and more. Labels remove cleanly and easily with no residue. For laser and inkjet printers. Round, ¾" diameter.

ORDER NUMBER	DESCRIPTION	UNIT
1	67933-02343 Red	240/PK
2	67933-02344 Green	240/PK
3	67933-02345 Blue	240/PK
4	67933-02346 Yellow	240/PK
5	67933-02348 Assorted	240/PK



Paper - name badges and holders

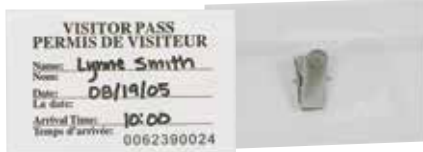

A MERANGUE FOLD-OVER NAME BADGE KITS

Perfect for meetings, conferences and other group get-togethers. Simple fold over design - just lift the flap and insert the card. Kits include clear plastic badge holders with white printable inserts. Clear.

ORDER NUMBER	DESCRIPTION	UNIT
1 1008-7401-00-000	2 1/8" x 3 1/2", clip on	10/PK
2 1008-7431-00-000	2 1/8" x 3 1/2", clip on	100/PK
3 1008-7391-00-000	2 1/8" x 3 1/2", pin	10/PK
4 1008-7421-00-000	2 1/8" x 3 1/2", pin	100/PK



B GEMEX® SECURITY CARD BADGE HOLDER

Protect and increase the life of costly magnetic access cards and employee ID cards. Pre-punched slot locks the card inside when used with lanyards, clips and other fasteners. Size: 2 1/4" x 3 1/2".



ORDER NUMBER	UNIT
CW-658	50/PK



C AVERY® HEAVY DUTY BADGE HOLDERS

Flexible heavyweight vinyl for everyday use. Pre-punched holes for lanyards and reel clips.



ORDER NUMBER	DESCRIPTION	UNIT
1 67933-74471	Horizontal, 3" x 4"	25/PK
2 67933-74472	Vertical, 4" x 3"	25/PK

D MERANGUE POCKET NAME BADGE KITS

For meetings, conferences and other group get-togethers. Simple pocket design sees three sides sealed with an easy insertion point at the top. String holder. Kit includes clear plastic badge holders with white printable inserts and string. Clear.



ORDER NUMBER	DESCRIPTION	UNIT
1 1008-7411-00-000	3" x 4"	10/PK
2 1008-7441-00-000	3" x 4"	100/PK

E AVERY® NAME BADGE KITS

Convention badges - choice of cord or clip style. Print name details using laser or inkjet printers. PVC free.



ORDER NUMBER	DESCRIPTION	UNIT
1 67933-05393	Cord kit, 4" x 3"	50/BX
2 67933-78617	Clip kit, 4" x 3"	75/BX
3 67933-05392	Tag refills, 4" x 3"	300/BX
4 67933-05390	Tag refills, 3 1/2" x 2 1/4"	400/BX

F MERANGUE® HEAVY DUTY BADGE HOLDERS

With pre-punched holes for lanyards or clips.



ORDER NUMBER	DESCRIPTION	UNIT
1 1008-4201-00000	Vertical, 3 7/8" x 2 5/8"	25/PK
2 1008-4211-00000	Horizontal, 2 5/8" x 3 7/8"	25/PK



G MERANGUE® BADGE REELS

Great for any environment requiring quick and easy access to ID badges.

ORDER NUMBER	UNIT
CARABINER WITH 36" CORD	
1 1008-3111-00-000	2/PK
BELT CLIP WITH 24" CORD	
2 1008-7592-00-000	25/PK

H AVERY® RETRACTABLE REEL CLIPS

Sturdy metal clip easily attaches reel to belt, extends 30" and automatically retracts for easy access.

ORDER NUMBER	UNIT
67933-74711	12/PK



I MERANGUE® ALLIGATOR BADGE CLIPS

For ID and other badges. Nickel-plated alligator clip with plastic snag loop.

ORDER NUMBER	UNIT
1008-3102-00-000	100/PK



Paper - name badges and holders



A AVERY® NECK HANGING LANYARDS

Keep keys, identification badges, whistles and other small items safe, and within reach. Breakaway safety clasp separates the lanyard easily. 35½" long.

ORDER NUMBER	DESCRIPTION	UNIT
67933-74710	Lanyards	12/PK



B GBC® BADGEMATES™ NYLON BADGE LANYARDS

For ID badges, etc. Round black lanyard with silver clip.

ORDER NUMBER	DESCRIPTION	UNIT
33816-05118	21"	12/PK

NEW!

C MERANGUE LANYARD WITH REEL

Lanyard breaks away at neck for safety. Detachable 24" badge reel has safety stop to prevent automatic retraction. Pull to extend, push safety button to retract. Includes removable metal key ring, badge clasp and USB holder. 17½" long. Black. 2¼"×3¾", 5 mil.



ORDER NUMBER	UNIT
1009-3010-20-000	EA



D MERANGUE® LANYARDS

Breakaway at top and bottom. Features key ring, badge clasp and breakaway USB holder. 37" long.

ORDER NUMBER	DESCRIPTION	UNIT
1 1009-3020-20-000	Black	EA
2 1009-3020-50-000	Blue	EA



E MERANGUE® SECURITY WRISTBANDS

Great for company functions, sporting events, business day pass and festivals. Sequentially numbered DuPont™ Tyvek®. Perforated for easy separation.

ORDER NUMBER	DESCRIPTION	UNIT
1 1008-4172-41-000	Yellow	100/PK
2 1008-4172-50-000	Blue	100/PK
3 1008-4172-70-000	Red	100/PK



F MERANGUE SELF-LAMINATING ID TAGS

No laminating machine required. Protect important documents and cards. Badge clips included. 6/pkg. 4"×2½".

ORDER NUMBER	UNIT
1026-7051-00-000	6/PK



G AVERY® WHITE ADHESIVE NAME BADGES

Flexible face stock allows badge to move with clothing while adhering securely to fabric. Peel away design for quick, easy, separation. Easy to apply - won't curl off. Laser and inkjet compatible, 3⅝"×2½".

ORDER NUMBER	DESCRIPTION	UNIT
1 67933-05395	White	400/BX
2 67933-05895	White with blue border	400/BX



H AVERY® NAME BADGES

These flexible adhesive name badges move with clothing and won't fall off or curl. Laser and inkjet compatible. 2½"×3⅝".

ORDER NUMBER	DESCRIPTION	UNIT
1 67933-02358	Red border	30/PK
2 67933-02359	Blue border	30/PK
3 67933-02351	Hello my name is	30/PK



I MERANGUE ID CARD HOLDER

Plastic loop with metal snap can be adjusted vertically or horizontally. Silicone. 3¾"×2½". Black.

ORDER NUMBER	UNIT
1009-3061-20-000	EA

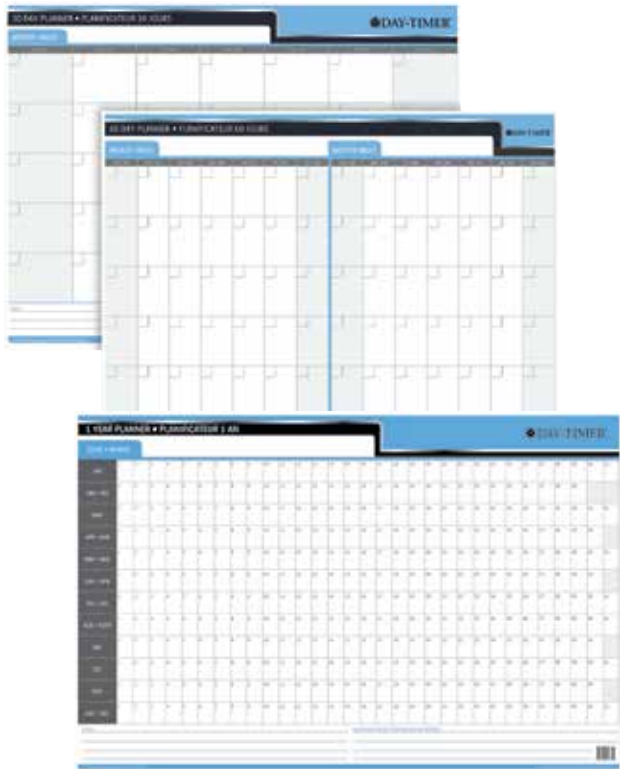

A DAY-TIMER® FLEXIBLE LARGE FORMAT REVERSIBLE PLANNERS

Bilingual perpetual laminated planners. Marker not included.

ORDER NUMBER	DESCRIPTION	UNIT
30 AND 60 DAY		
1 34138-59736	17"×24"	EA
2 34138-59735	23"×30"	EA
3 34138-59734	24"×36"	EA
90 AND 120 DAY		
4 34138-59737	24"×36"	EA
1 YEAR HORIZONTAL AND 1 YEAR VERTICAL		
5 34138-59739	24"×36"	EA



D DAY-TIMER® WALL PLANNERS

Perpetual planners printed in English. Black vinyl frame. 24"×36". Monthly planner or four-month planner versions.

ORDER NUMBER	DESCRIPTION	UNIT
1 34138-59730	Monthly	EA
2 34138-59731	Four-month	EA

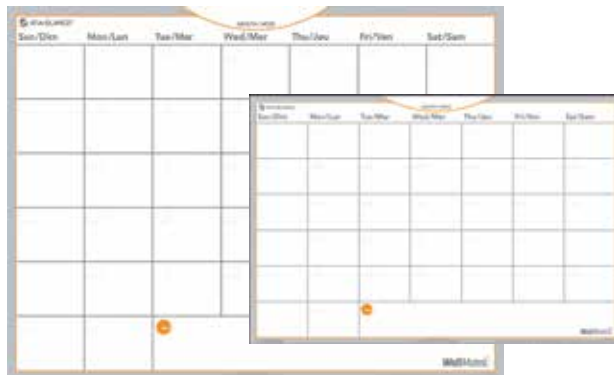

B AT-A-GLANCE® WALLMATES™ SELF-ADHESIVE DRY ERASE MONTHLY PLANNER

Undated monthly format with hot reminder notes area. Repositionable peel and stick adhesive requires no tools, leaves no residue. Adheres to most hard, flat surfaces. Dry erase marker included.

ORDER NUMBER	DESCRIPTION	UNIT
AW5021-28	24"×18"	EA

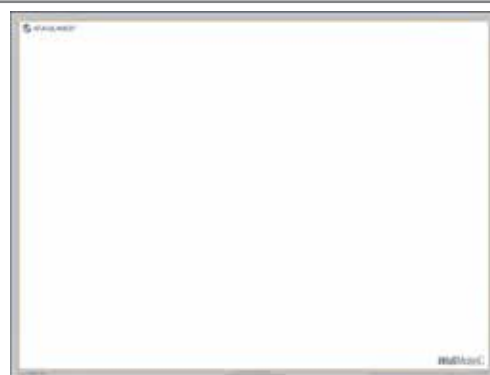

C AT-A-GLANCE® WALLMATES™ SELF-ADHESIVE DRY ERASE WRITING SURFACE

Blank surface that can be used for a variety of purposes. Repositionable peel and stick adhesive requires no tools, leaves no residue. Adheres to most hard, flat surfaces. Dry erase marker included.

ORDER NUMBER	DESCRIPTION	UNIT
AW5011-28	24"×18"	EA

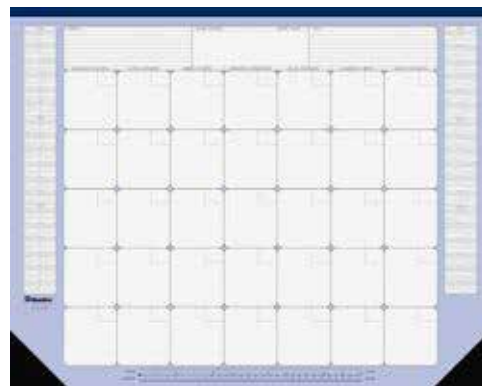

E BLUELINE® DESK PAD

Perpetual bilingual calendar with one page per month. Contains 50% post-consumer recycled paper. Reinforced chipboard backer and corners. FSC® certified.

ORDER NUMBER	DESCRIPTION	UNIT
A181722B	22"×17"	EA

Calendars & Planners – perpetual



A BLUELINE® NOTEPRO™ UNDATED DAILY PLANNER

Twin wire binding with hard lizard-like cover. Lies completely flat. Yearly planner. Undated planner on left side, ruled with margin on right side. Complete utility section with perpetual calendar, telephone and address section. Index sheet, self-adhesive tabs and storage pocket included. Bilingual. Black. FSC® certified.

ORDER NUMBER	DESCRIPTION	UNIT
1 A29C-81B	192 pages, 9¼"×7¼"	EA
2 A30C-81B	200 pages, 10¾"×8½"	EA



B BLUELINE® DAILY PERPETUAL APPOINTMENT BOOK

Perfect bound book with hard cover; trilingual 11"×8½" printed pages to record times and dates; 5 columns per page; appointment schedule from 7 am to 8:45 pm in 15-minute intervals. Contains 50% post-consumer recycled paper. FSC® certified.

ORDER NUMBER	DESCRIPTION	UNIT
A2000-81B	Black	EA

OFFICE
SUPPLIES



C BLUELINE® UNDATED TASK PLANNER

Twin-wire binding and flexible cover with duvet lamination. Today's plan, priorities, calls and notes sections. 50% post-consumer recycled paper. FSC® certified. Black. Bilingual.

ORDER NUMBER	DESCRIPTION	UNIT
B310B.81	270 pages, 9¼" x 7¼"	EA



D BLUELINE® DATE BOOK

Wire bound, perpetual, 8"×5". Telephone and address section. Black cover, bilingual print. Contains 50% post-consumer recycled paper. FSC® certified.

ORDER NUMBER	DESCRIPTION	UNIT
A6236-81BT	1 day/page, hourly appt. from 8am to 8pm	EA



E INNOVATIVE TEACHER DAILY PLAN BOOKS

Features colour-coded separate plan and record sections. Includes daily planning pages, record section, time tables, seating plans, meetings and more. 1 page per day. English. Coil bound. 8½"×11".

ORDER NUMBER	DESCRIPTION	UNIT
1 01-0100	Elementary	EA
2 02-0100	Secondary	EA



A ESSENTIAL DAILY PLANNER

Soft cover; twin wire bound; 11"×8½". Appointment schedule 7 am - 8:30 pm, half-hour intervals; space for evening appointments. "Things to do" section on each page. Black

ORDER NUMBER	DESCRIPTION	UNIT
1 C965.81BT	BlueLine® Bilingual	EA
2 CB965.BLK	BrownLine® English	EA



B BLUELINE® DAILY PLANNER

Spiral binding with durable poly cover. Appointment schedule from 7:00 am to 7:30 pm in 1/2 hour intervals. Saturday and Sunday on one page. Past, current and following months on each spread.

ORDER NUMBER	DESCRIPTION	UNIT
1 C2504.81T	English	EA
2 C2504.81BT	Bilingual	EA



C BROWNLINE® DAILY PLANNERS

Page size 8"×5"; appointment schedule 7 am - 7:30 pm, half-hour intervals, for full week. Three blocks per page for reminder notes and calls. Monthly planner before each month. Traditional: Hard cover; perfect bound; English. CoilPRO™: Hard cover; twin wire bound; English. Self-adhesive tabs and storage pocket included. Black.

ORDER NUMBER	DESCRIPTION	UNIT
1 CB634.BLK	Traditional	EA
2 CB634C.BLK	CoilPRO™	EA



D BROWNLINE® TRADITIONAL DAILY PLANNER

Hard cover; 13¾"×8"; sewn binding; English. Appointment schedule 7 am - 7 pm, half-hour intervals; space for evening appointments. Cash record section. Green marble with black spine and trim.

ORDER NUMBER	DESCRIPTION	UNIT
C530F	Traditional	EA



E BROWNLINE® DAILY PLANNERS

Large faint ruled areas for entries; cash record section; current and perpetual calendars. Traditional: Hard cover; perfect bound. Colours: **BLK** Black, **RED** Red. CoilPRO™: Hard cover; twin wire bound. Self-adhesive monthly laminated tabs and storage pocket included.

ORDER NUMBER	DESCRIPTION	UNIT
1 C550.____	Traditional, 10"×7⅞", specify colour	EA
2 C551.____	Traditional, 13¾"×7⅞", specify colour	EA
3 C550C.RED	CoilPRO™, 10"×7⅞", Red	EA
4 C551C.RED	CoilPRO™, 13¾"×7⅞", Red	EA

F BLUELINE® DAILY EXECUTIVE PLANNER

Appointment schedule from 7 am to 10:45 pm in 15 minute intervals. Calendar for 8 months on each spread. Shaded priority boxes for special notes on each spread. Telephone address section. Bonded leather cover material. Trilingual. 10¾"×7¾".

ORDER NUMBER	DESCRIPTION	UNIT
CBE514	Hard cover, Black	EA



H BROWNLINE® 4-PERSON DAILY PLANNERS

11"×8½". Four columns with appointment schedule from 7:00 a.m. to 8:45 p.m. in 15-minute intervals. Saturday and Sunday on the same page. Twin-wire binding. Minimum of 50% post-consumer fibre. FSC® certified. Black. English.

ORDER NUMBER	DESCRIPTION	UNIT
1 CB960.BLK	Soft lizard-like cover	EA
2 CB960C.BLK	Hard lizard-like cover	EA

G DAYMINDER® RECYCLED DAILY APPOINTMENT BOOK

Simulated leather cover; twin wire bound. Hourly appointments, 7 am - 5 pm, one weekday per page; 4⅞"×8".



ORDER NUMBER	DESCRIPTION	UNIT
SF44-00	Bilingual, Black	EA

Our Brand, YOUR Savings! 



A OP BRAND DAILY DIARY
Soft cover; double coil binding. Black matte embossed cover. One day per page, appointment schedule 7 am to 8 pm, half-hour intervals.

ORDER NUMBER	DESCRIPTION	UNIT
27811-40003-23	English 8"×5"	EA



B BLUELINE® ESSENTIAL DAILY PLANNERS
Soft cover; spiral bound unless specified; 8"×5". Appointment schedule 7 am - 7:30 pm, half-hour intervals. Note box on each page; section for monthly expenses at the end of each month. 50% post-consumer recycled paper. FSC® certified. Colours: **81** Black, **82** Navy, **83** Burgundy.



ORDER NUMBER	DESCRIPTION	UNIT
1 C1504._T	English, specify colour	
2 C1504._BT	Bilingual, specify colour	
3 C1504.81	English, Black hard cover	EA



C QUO VADIS® EXDI DAILY PLANNER
Wire bound, 12 month planner with hourly appointments 8 am to 9 pm. Monthly calendar before each month. Note section at the bottom of each page and includes address section. Assorted blue and black covers. 8¼"×6".

ORDER NUMBER	DESCRIPTION	UNIT
99102	Bilingual	EA





D BLUELINE® ESSENTIAL DAILY POCKET PLANNER
Soft cover, spiral bound, 6"×3½"; Bilingual. Appointment schedule from 7 am to 7:30 pm in half-hour intervals. Telephone and address section. Section for monthly expenses at the end of each month.

ORDER NUMBER	DESCRIPTION	UNIT
1 C1501.81BT	Black	EA
2 C1501.82BT	Blue	EA



E BROWNLINER® ESSENTIAL DAILY PLANNERS
Soft cover; twin wire bound; English; 8"×5". Appointment schedule 7 am - 7:30 pm, half-hour intervals, for full week. Three blocks for reminder notes and calls per page. Monthly planner before each month. Colours: **BLK** Black, **BLU** Blue, **RED** Red, **GRN** Green.

ORDER NUMBER	DESCRIPTION	UNIT
CB634W._	Specify colour	EA



F BROWNLINER® TRADITIONAL DAILY PLANNER
Hard cover; sewn binding; English. Appointment schedule 7 am - 7 pm, half-hour intervals; space for evening appointments. Cash record and telephone/address sections. Green with black spine and trim. Gold ribbon bookmark.

ORDER NUMBER	DESCRIPTION	UNIT
C517F	8½"×6¾"	EA



G BLUELINE® PINK RIBBON COLLECTION DAILY DIARY
Twin wire bound, 8"×5". Your purchase will help to surpass the goal of this year in support of the breast cancer cause. ½ hour appointments from 7:00 a.m. to 7:30 p.m.

ORDER NUMBER	DESCRIPTION	UNIT
C1504W.95BT	Bilingual, Pink	EA



H DAYMINDER® RECYCLED DAILY FOUR PERSON GROUP APPOINTMENT BOOK
Simulated leather cover, 7½"×11"; twin wire bound; English. Quarter-hourly appointments, 7 am - 7:45 pm, one weekday per page; page divided for group practice. Three past, current and four future months reference.

ORDER NUMBER	DESCRIPTION	UNIT
G560-00	Black	EA



A BLUELINE® WEEKLY TIMANAGER® PLANNERS

Twin wire bound; English; 13 month; 10¼"×7⅞". Five-day planner with monthly planner at the start of each month. Appointment schedule 7 am - 8:30 pm in half-hour intervals; C5900 includes telephone/address booklet; C5905 has telephone/address section, self-adhesive laminated tabs and a storage pocket. FSC® certified paper.



ORDER NUMBER	DESCRIPTION	UNIT
1 C5900.81	Soft vinyl cover, black	EA
2 C5905.81	CoilPRO™ hardcover, Black	EA



C BLUELINE® WEEKLY 7-DAY TIMANAGER® PLANNER

Soft vinyl cover; twin wire bound; English; 13 month; 11"×8½". Seven-day planner with monthly planner at the start of each month. Appointment schedule 7 am - 8:30 pm in half-hour intervals. Includes telephone and address book. FSC® certified paper.



ORDER NUMBER	DESCRIPTION	UNIT
C5930.81T	Black	EA



E BROWNLINE® WEEKLY PLANNERS

Soft cover and twin wire binding. Hourly appointment schedule 7 am - 6 pm. Lined spaces for Saturday & Sunday. Telephone and address section indexed with tabs in CB100.BLK. English. FSC® certified paper.



ORDER NUMBER	DESCRIPTION	UNIT
1 CB100.BLK	Essential, 8"×5", Black	EA
2 CB75.BLK	Essential, 8"×5", Black	EA



G BROWNLINE® ESSENTIAL WEEKLY POCKET PLANNER

Soft vinyl cover; perfect bound; English; 4"×2⅝". Ruled block for each day. Telephone and address section. Assorted cover colours: black, navy and burgundy. FSC® certified paper.



ORDER NUMBER	DESCRIPTION	UNIT
CB404.ASX	Pocket planner	EA

Our Brand, YOUR Savings !



B OP BRAND WEEKLY DIARIES

Soft black matte embossed cover; double coil binding. One week per two-page spread; appointment schedule: 7 am–8 pm, one hour intervals. Bilingual.



ORDER NUMBER	DESCRIPTION	UNIT
1 27811-40005-23	8"×5"	EA
2 27811-40004-23	8½"×11"	EA



Cover Colours: **02** Black, **05** Blue

D QUO VADIS® WEEKLY SAPA X PLANNER

One week on two pages. Appointment schedule from 8:00 a.m. to 7:00 p.m. in hour intervals. Fully stitched binding. English. Colours: **02** Black, **05** Blue.

ORDER NUMBER	DESCRIPTION	UNIT
46265E__	3 ½"×5 ½", Specify colour	EA

F QUO VADIS® PRENOTE AND TRINOTE WEEKLY PLANNERS

One week on two pages with daily notes. White paper, stitched binding, detachable address book. Black cover. Trinote specify: **E** English, **F** French.

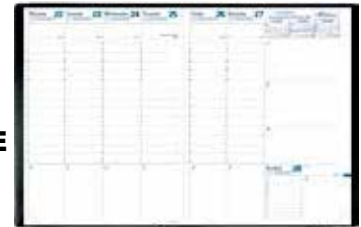

ORDER NUMBER	DESCRIPTION	UNIT
1 24102E02	Prenote, 8¼"×11¾", English	EA
2 48102_02	Trinote, 7¼"×9½"	EA
3 24001E	Prenote refill, English	EA
4 48001_	Trinote refill	EA

H QUO VADIS® WEEKLY PRESIDENT & MINISTER PLANNERS

Thirteen months, December–December. One week on two pages; detachable booklet. Black cover; stitched binding. Specify: **E** English, **F** French.



ORDER NUMBER	DESCRIPTION	UNIT
1 16102_02	President, 8¼"×10¾"	EA
2 15102_02	Minister, 6¼"×9½"	EA
3 16001_	President refill	EA
4 15001_	Minister refill	EA



A DAYMINDER® EXECUTIVE WEEKLY/MONTHLY PLANNER

Soft, padded cover of this planner delivers executive appeal and is refillable to use for years to come. Included weekly planning pages with tabbed monthly calendars make it easier to get a handle on a busy schedule. 6 7/8" x 8 3/4" Black.

ORDER NUMBER	DESCRIPTION	UNIT
1 G545-00	Planner	EA
2 G545-50	Refill	EA



B BLUELINE® NET ZERO CARBON™ WEEKLY PLANNER

Twin-wire binding with soft cover. Weekday hourly appointments from 7:00 a.m. to 6:00 p.m. Ruled spaces for Saturday and Sunday. Perforated tear-off corners. Bilingual. 8" x 5". 50% post-consumer recycled paper. FSC® certified.

ORDER NUMBER	DESCRIPTION	UNIT
C815.81BT	Black	EA



C BROWNLINE® ESSENTIAL WEEKLY APPOINTMENT BOOK

Twin wire binding with soft cover. Appointment schedule: weekday, 7 am to 8:45 pm, 15-minute intervals; Saturday, 7 am to 5:45 pm, 15-minute intervals; Sunday, ruled spaces. Telephone and address section. English, 11" x 8 1/2". CoilPRO™ hard cover version includes self-adhesive laminated tabs and a storage pocket.

ORDER NUMBER	DESCRIPTION	UNIT
1 CB950.BLK	Black	EA
2 CB950.BLU	Blue	EA
3 CB950.RED	Red	EA
4 CB950C.BLK	CoilPRO™, hard cover, Black	EA



D BLUELINE® ESSENTIAL WEEKLY PLANNER

Twin wire binding with soft lizard-like cover. Weekly appointment schedule: weekday, 7 am to 8:45 pm, 15-minute intervals; Saturday, 7 am to 4:45 pm, 15-minute intervals; ruled spaces for Sunday. Telephone and address section. Bilingual, 11" x 9 1/8".

ORDER NUMBER	DESCRIPTION	UNIT
C5950.81BT	Black	EA



E BLUELINE® TIMANAGER® COILPRO™ WEEKLY PLANNER

Twin wire binding with hard lizard-like cover. Thirteen month, December to December. Seven-day planner with monthly planner before each month. Appointment schedule: weekday, 7 am to 8:30 pm, half-hour intervals; boxes for priorities, phone calls, correspondence and personal notes on each spread. Telephone and address section. English, 11" x 8 1/2". Self-adhesive laminated tabs and storage pocket.

ORDER NUMBER	DESCRIPTION	UNIT
C5930C.81	Black	EA



F BLUELINE® TIMANAGER® WEEKLY PLANNER

Twin wire binding with soft Castilian vinyl jacket. Thirteen month, December to December. Six-day planner with monthly planner before each month. Appointment schedule: 7 am to 8:30 pm, half-hour intervals; boxes for priorities, phone calls, correspondence and personal notes on each spread. English, 11" x 8 1/2".

ORDER NUMBER	DESCRIPTION	UNIT
C5940.81T	Black	EA



G DAYMINDER® RECYCLED WEEKLY APPOINTMENT BOOK

Twin coil bound, simulated leather cover. One week per spread; hourly appointments, 8 am to 5 pm; past, current and two future months reference. Tabbed telephone and address section. Bilingual, 4 7/8" x 8".

ORDER NUMBER	DESCRIPTION	UNIT
GF210-00	Black	EA



H DAYMINDER® RECYCLED WEEKLY APPOINTMENT BOOK

Twin coil bound, simulated leather cover. One week per spread. Appointments: weekdays, 7 am to 9:45 pm, 1/4-hour; Saturday, 7 am to 6:45 pm, 1/4-hour; past, current and two future months reference. Bilingual, 8" x 11".

ORDER NUMBER	DESCRIPTION	UNIT
GF520-00	Black	EA





A DAYMINDER® WEEKLY PLANNER

Vinyl cover; perfect bound; 3½"×6¾". Ruled; one week per 2-page spread. Current and future months reference. Bilingual.



ORDER NUMBER	DESCRIPTION	UNIT
SF48-00	Black	EA



B BLUELINE® WEEKLY TIMANAGER® PLANNER

Soft vinyl; twin wire bound; English; 13 month; 9¼"×5½". Five-day planner with monthly planner at the start of each month. Appointment schedule 7 am - 8:30 pm in half-hour intervals. With telephone and address book. FSC® certified paper.



ORDER NUMBER	DESCRIPTION	UNIT
C5910.81	Black	EA



C TIMANAGER® WEEKLY/MONTHLY PLANNER

January through December planning with each week shown on a two-page spread. Appointments 7:00 am - 6:30 pm. Twin-wire binding and a monthly planner at the beginning of each month. Black. English.



ORDER NUMBER	DESCRIPTION	UNIT
C5933.81T	11"×8½"	EA

D AT-A-GLANCE® QUICKNOTES® WEEKLY/MONTHLY APPOINTMENT BOOK

Simulated leather cover, 9⅞"×8", twin wire bound; bilingual. Weekly - one week per spread, hourly appointments, 8 am - 5 pm including weekends. Monthly - full month on left page, QuickNotes on right page; two past, six future months reference.



ORDER NUMBER	DESCRIPTION	UNIT
76-01F-05	Black	EA

E BROWNLINE® WEEKLY EXECUTIVE PLANNER

Sewn binding. Appointments 7:00 a.m. to 6:00 p.m. in 15 minute intervals. Yearly calendar at the bottom of each spread. Each spread has shaded notes and priority boxes. Black. Trilingual.

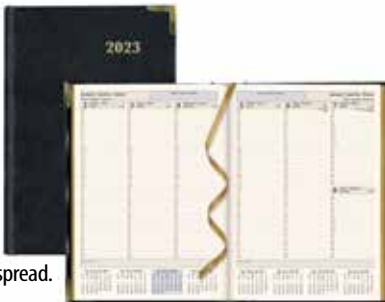

ORDER NUMBER	DESCRIPTION	UNIT
CBE512	10¾"×7¾"	EA



F BLUELINE® TIMANAGER® PINK RIBBON COLLECTION WEEKLY PLANNER

Weekday appointment schedule from 7am to 7:30pm, half-hour intervals. Monthly planner at the start of each month. Twin wire binding, soft cover. Contains 50% post-consumer recycled paper. FSC® certified.



ORDER NUMBER	DESCRIPTION	UNIT
CBBM2.PNK	8½"×6¾"	EA



G BROWNLINE® WEEKLY PLANNER

Twin wire bound; English; 8½"×6¾. Lined spaces for each day; full month calendar at start of month. Tabbed monthly expense divider pages. Telephone and address section. 50% post-consumer recycled paper.



ORDER NUMBER	DESCRIPTION	UNIT
CB850.BLK	Essential, soft cover, black	EA



H MEAD® WEEKLY/MONTHLY TROPICAL PLANNER

Twin-coil bound. One week per two-page spread with tabs. One month per two-page spread with tabs. Colourful tropical scenes on top portion of each page. Assorted Blue and Teal covers. Bilingual.



ORDER NUMBER	DESCRIPTION	UNIT
TL385F-10	5⅞"×8¼"	EA

Calendars & Planners – monthly



A BROWNLINE® ESSENTIAL MONTHLY PLANNERS

One month per spread; telephone and address section. English. FSC® certified paper, black lizard cover; 11"×8½".

ORDER NUMBER	DESCRIPTION	UNIT
1 CB1260.BLK	16 month Sept.-Dec.	EA
2 CB1262.BLK	14 month Dec.-Jan	EA



B AT-A-GLANCE® YOPRO WEEKLY/ MONTHLY PLANNERS

Twin wirebound with faux leather cover. 13-months, Jan.-Jan., tabbed one week per two page spread. Contact pages, note pages, event calendar and holidays. Interior pocket. Colours: **08** Grey, **09** Brown.

ORDER NUMBER	DESCRIPTION	UNIT
YP905-__	8½"×11" Specify colour	EA



C BLUELINE® MONTHLY CANADIAN PROVINCES PLANNER

Twin-wire with soft Canberra cover. Colourful image of a province every month. 14-months, December to January and coloured world maps. Black. Bilingual.

ORDER NUMBER	DESCRIPTION	UNIT
C1218.81BT	8½"×7½"	EA



D BROWNLINE® MONTHLY PLANNERS

Twin wire bound; English; 8½"×7½". Fourteen-month planner, December to January; one month per spread, one lined block per day. CoilPRO™ (hard cover) includes self-adhesive laminated tabs and a storage pocket. FSC® certified.

ORDER NUMBER	DESCRIPTION	UNIT
1 CB1200.BLK	Essential, soft cover, Black	EA
2 CB1200C.BLK	CoilPRO™, Black	EA



E BROWNLINE® MONTHLY/WEEKLY PLANNER

Stitched binding and black soft lizard-like cover. Two weeks on each spread. Lined spaces for each day. FSC® Certified. 6"×3½".

ORDER NUMBER	DESCRIPTION	UNIT
C5626.81Z	English	EA



F BLUELINE® MIRACLEBIND™ MONTHLY PLANNERS

Bilingual planners, 16 months, September to December; English, 17 months, August to December. Twin wire binding with CoilPro™ hard lizard-like cover. One month per spread, 30 ruled pages that can be removed and reinserted. Self-adhesive tabs. Black, 9¼"×7¼". Includes storage pocket. FSC® certified. Bilingual.

ORDER NUMBER	UNIT
CF1200C.81B	EA



G BLUELINE® ESSENTIAL MONTHLY PLANNER

Twin wire bound; soft lizard-like cover. Sixteen-month planner, September to December; one month per spread, one ruled block per day; telephone and address section. Bilingual; 9¼"×7¼". FSC® certified.

ORDER NUMBER	DESCRIPTION	UNIT
C1200.81BT	Black	EA



H BROWNLINE® ESSENTIAL MONTHLY POCKET PLANNER

Stitched binding; English; 6½"×3½". Two-year planner (Jan. - Dec.), one month per spread. Individual daily boxes; space for notes. FSC® certified.

ORDER NUMBER	DESCRIPTION	UNIT
1 CA424.ASX	Assorted prints	EA
2 CA24.AST	Assorted colours	EA



I DAYMINDER® RECYCLED MONTHLY PLANNER

Twelve months, January to December, one month per two-page spread. Past, current and four future months reference. Memo section with space for notes. Twin coil bound. Bilingual. 6½"×8¾". Black.

ORDER NUMBER	DESCRIPTION	UNIT
GF400-00	Simulated leather	EA



A AT-A-GLANCE® WALLMATES™ SELF-ADHESIVE DRY-ERASE YEARLY CALENDAR

Twelve-month format perfect for long-range planning. Repositionable peel and stick adhesive requires no tools, leaves no residue. Adheres to most hard, flat surfaces. Surface works with most dry-erase markers; one marker included.

ORDER NUMBER	DESCRIPTION	UNIT
AW5061-28	18"×24"	EA



B DAY-TIMER® REVERSIBLE FLEXIBLE CALENDAR

Write on/wipe off laminated calendar. Can be used with dry erase markers. Horizontal seasonal format. One side English, one side French.

ORDER NUMBER	DESCRIPTION	UNIT
34138-03747	24"×36"	EA



C DAY-TIMER® REVERSIBLE FLEXIBLE CALENDAR

Write on/wipe off laminated calendar. Can be used with dry erase markers. Format: one side vertical, one side horizontal. Bilingual.

ORDER NUMBER	DESCRIPTION	UNIT
34138-03744	24"×36"	EA



D AT-A-GLANCE® RECYCLED MONTHLY WALL CALENDARS

One month per page with 12-month calendar reference. Full chipboard back. Bilingual.

ORDER NUMBER	DESCRIPTION	UNIT
1 PM2F-28	12"×17"	EA
2 PM3F-28	15½"×22¾"	EA



E BROWLINE® YEARLY WALL CALENDAR

Browline® yearly wall calendar is printed on both sides; horizontal and vertical. Laminated coating enables use with erasable markers. Metal support with eyelets to hang. 50% post-consumer recycled paper. English.

ORDER NUMBER	DESCRIPTION	UNIT
C177468	32"×48"	EA

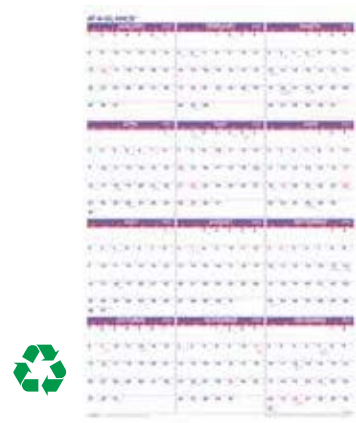

F AT-A-GLANCE® RECYCLED YEARLY WALL CALENDAR

Twelve months on one page, quarterly rows. Contemporary design, lots of writing space. Metal bound with hanging eyelet top and bottom.

ORDER NUMBER	DESCRIPTION	UNIT
PM12-28	24"×36"	EA



G MOTHERWORD® MOM'S ULTIMATE CALENDAR DELUXE VERSION

The perfect family organizer. Full-colour, 16-month (Sept.–Dec.). Use as a fridge, desk or wall calendar. Quick access tab to any month. Easy to write on; displays a month of activities at a glance! 660 "Reminder" stickers: place on days, mark appointments, activities or vacations. Super strong magnets included.

ORDER NUMBER	DESCRIPTION	UNIT
1 MWFCT128	18"×13.5", English	EA
2 MWFFT128	18"×13.5", French	EA

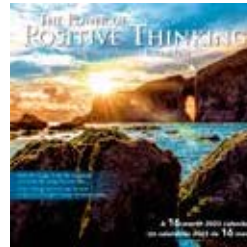

H AT-A-GLANCE® POWER OF POSITIVE THINKING WALL CALENDAR

Bilingual; page size 11"×12". Sixteen months, September to December, featuring 13 full colour images with inspirational quotes. FSC® certified. 100% recyclable.

ORDER NUMBER	UNIT
DDF143-28	EA



Calendars & Planners – desk pads



A BLUELINE® & BROWNLINER® DESK PADS/WALL CALENDARS

One month per sheet, one block per day with yearly reference calendar at bottom. Tear-off sheets, bound at top and perforated. Notes section on the side. Reinforced chipboard backer and corners.

ORDER NUMBER	DESCRIPTION	UNIT
1 C181721	11"×8½", English NEW!	EA
2 C181700	17¾"×10⅞", English	EA
3 C181731	21¼"×16", English	EA
4 C181731B	21¼"×16", Bilingual	EA

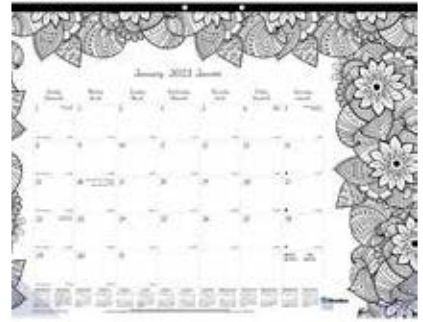

B BLUELINE® DOODLEPLAN™ COLOURING DESK PAD

Reinforced chipboard backer. One month on each sheet, one block per day. Yearly calendar at the bottom of each sheet. Tear off sheets, bound at the top. Printed on 24lb paper. Bilingual. 50% recycled post-consumer paper. Botanica design.

ORDER NUMBER	DESCRIPTION	UNIT
C2917311B	22"×17"	EA



C BLUELINE® MONTHLY DESK PAD WITH VINYL STRIP

Reinforced chipboard backer and corners. One month on each sheet, one block per day. Yearly calendar at the bottom of each sheet, punched for hanging, tear-off sheets and bound at the top. Vinyl strip at the bottom to hold things in place. Bilingual.

ORDER NUMBER	DESCRIPTION	UNIT
C181731BV	21¼"×16"	EA



100% - ECOLOGICAL TIP ON EACH SHEET

D BLUELINE® & BROWNLINER® ECOLOGIX® DESK PADS

One month per sheet, one block per day. Yearly calendar at bottom of each sheet; reinforced chipboard backer. Non-refillable; 100% recycled post-consumer material. FSC® certified.

ORDER NUMBER	DESCRIPTION	UNIT
1 C177437	22"×17", English	EA
2 C177437B	22"×17", Bilingual	EA



E BROWNLINER® DESK PAD & REFILLS

One month per sheet, one lined block per day; yearly reference calendar at bottom.

ORDER NUMBER	DESCRIPTION	UNIT
1 C191924	Pad & holder, 24¼"×19⅞"	EA
2 C191924R	23½"×18⅜", refill	EA



F BLUELINE® PINK RIBBON MONTHLY DESK PADS

One month per sheet; monthly calendar at bottom of sheet. Reinforced chipboard backer and corners. Bilingual.

ORDER NUMBER	DESCRIPTION	UNIT
C1831BPNK	22"×17"	EA



G AT-A-GLANCE® DAYMINDER® MONTHLY DESK PAD

Contains minimum 30% post-consumer recycled material. 1 month per sheet. Full year calendar reference at bottom of sheet. Countdown of days past and days to come to end of year. Bilingual.



ORDER NUMBER	DESCRIPTION	UNIT
SK24FB-00	22"×17"	EA

Calendars & Planners – organizers and refills



A DAY-TIMER® AVALON LEATHER-LIKE STARTER SET

Heavy duty vinyl with an embossed leather-grain finish. Features outside pocket. Includes 3 month undated sampling of most popular formats.

ORDER NUMBER	DESCRIPTION	UNIT
67199-68357	Desk size (loose leaf) 8½"×5½"	EA



B DAY-TIMER® DAILY ORGANIZER REFILLS

One page per day. Contains a minimum of 30% post-consumer recycled material.

ORDER NUMBER	DESCRIPTION	UNIT
1 67199-68512	Portable size, 6¾"×3¾"	PK
2 67199-68502	Desk size, 8½"×5½"	PK
3 67199-68531	Folio size, 11"×8½"	PK



C DAY-TIMER® DAILY ORGANIZER REFILLS

Two pages per day. Contains a minimum of 30% post-consumer recycled material.

ORDER NUMBER	DESCRIPTION	UNIT
1 67199-68522	Pocket size, 6½"×3½"	PK
2 67199-68501	Desk size, 8½"×5½"	PK
3 67199-68534	Folio size, 11"×8½"	PK



D DAY-TIMER® WEEKLY ORGANIZER REFILLS

Two pages per week. Contains a minimum of 30% post-consumer recycled material.

ORDER NUMBER	DESCRIPTION	UNIT
1 67199-68513	Portable size, 6¾"×3¾"	PK
2 67199-68503	Desk size, 8½"×5½"	PK
3 67199-68532	Folio size, 11"×8½"	PK



E DAY-TIMER® MONTHLY ORGANIZER REFILLS

Two pages per month. Contains a minimum 30% post-consumer recycled material.

ORDER NUMBER	DESCRIPTION	UNIT
1 67199-68514	Portable size, 6¾"×3¾"	PK
2 67199-68504	Desk size, 8½"×5½"	PK
3 67199-68533	Folio size, 11"×8½"	PK

Calendars & Planners – academic

Cover Colours:



A BROWNLINE® ESSENTIAL MONTHLY POCKET PLANNER

Soft vinyl cover; stitched binding; English. 18 month planner, July to December; one month per spread. Individual daily boxes; space for notes. Contains 50% post-consumer recycled paper. FSC® certified. Assorted colours: black, navy, burgundy and green.

ORDER NUMBER	DESCRIPTION	UNIT
CA12.AST	6½"×3½"	EA

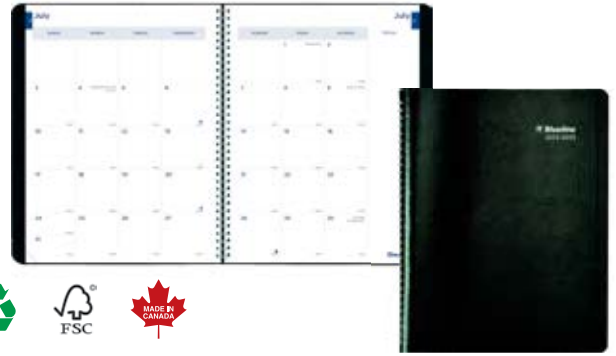

B BROWNLINE® MONTHLY ACADEMIC PLANNER

14 month planner - July to August. One month on each spread, one ruled block per day. Telephone and address section. Twin wire binding. 100% post-consumer recycled paper. FSC® certified. Black.

ORDER NUMBER	DESCRIPTION	UNIT
CA701.BLK	11"×8½"	EA

OFFICE SUPPLIES



C QUO VADIS® SCHOLAR PLANNER

One week per 2-page spread; 12 months, August to July. Detachable booklet, memo area, stitched binding. Colours: **05** Blue, **11** Grey, **24** Lilac.

ORDER NUMBER	DESCRIPTION	UNIT
55265E_	6¼"×9½"	EA

Cover Colours:



D DAYMINDER® ACADEMIC DAILY APPOINTMENT BOOK

Twelve months (July-June). Hourly appointments, 7:00 a.m. - 5:00 p.m. Space for evening appointments/notes. Weekly schedule. Assorted.

ORDER NUMBER	DESCRIPTION	UNIT
AY44F-10	4¾"×8"	EA

Cover Colours:

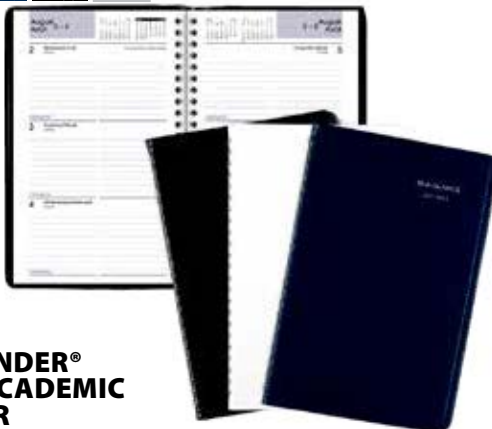

E DAYMINDER® WEEKLY ACADEMIC CALENDAR

13 months (August-August). Ruled format for open appointment scheduling/notes. Weekly schedules, future planning, notes section. Telephone/address pages. Special information section. Assorted.

ORDER NUMBER	DESCRIPTION	UNIT
AY41F-10	4¾"×8"	EA



F BLUELINE® MONTHLY ACADEMIC DESK PAD CALENDAR

Thirteen-month, July - July. One month per tear-off page, one block per day; notes section on side. Reinforced chipboard backer and corners.

ORDER NUMBER	DESCRIPTION	UNIT
CA181731	21¼"×16"	EA



FILOFAX®

Schneider  Write it
Made in Germany



A CANADIAN COMPANY



Your trusted brand for over 100 years

Our Brand, YOUR Savings!



A OP BRAND CLASSIC COIL NOTEBOOKS

Notebook will lie completely flat. Acid-free paper is ruled with a margin. Hard cover. Features a poly slant pocket at the back of the book. Twin coil bound. 192 page.

ORDER NUMBER	DESCRIPTION	UNIT
1 27811-50050	9"×7¼", Black	EA
2 27811-50051	9"×7¼", Blue	EA



B BLUELINE® NOTEPRO™ EXECUTIVE NOTEBOOKS

With hard lizard-like cover and twin wire binding. Ruled micro-perforated pages with margin. Includes self-adhesive tabs, index sheet and storage pocket. Contains 50% post-consumer recycled paper. FSC® certified.

ORDER NUMBER	DESCRIPTION	UNIT
1 A10200-BLK	10¾"×8½", Black, 200 pages	EA
2 A10200-RED	10¾"×8½", Red, 200 pages	EA
3 A10300-BLK	10¾"×8½", Black, 300 pages	EA

C CAMBRIDGE® WIREBOUND BUSINESS NOTEBOOKS

Durable professional cover with tear-off top sheet. 20 lb. smooth paper pad, with micro perforations for clean tear out. Extra thick, stiff back for a sturdy writing surface.

ORDER NUMBER	DESCRIPTION	UNIT
43100-06364	Side bound, 9½"×7¼", 160 pages	EA



D BLUELINE® MIRACLEBIND™ NOTEBOOKS

MiracleBind™ pages are easily removable and reinsertable many times over, their secret formula treatment allow pages to reseal themselves. Micro-perforated pages contain 50% post-consumer recycled paper and vegetable oil based inks. Notebooks feature twin wire binding with hard lizard-like black cover. Includes 150 MiracleBind™ ruled pages, index sheet, self-adhesive tabs and storage pocket. FSC® certified.

ORDER NUMBER	DESCRIPTION	UNIT
1 AF9150.81	Notebook, 9¼"×7¼", Black	EA
2 AF9150.85	Notebook, 9¼"×7¼", Turquoise	EA
3 AF11150.81	Notebook, 11"×9½", Black	EA
4 AFR9050R	Refill, 9¼"×7¼", 100 pages	PK
5 AFR11050R	Refill, 11"×9½", 100 pages	PK

E BLUELINE® NOTEPRO™ PROJECT NOTEBOOK

Refillable with MiracleBind™ sheets. Contains a minimum of 50% post-consumer recycled material. FSC® Certified. Hard, lizard like cover. Twin wire bound. Features index sheet, self-adhesive tabs and storage pocket. Micro-perforated, blue ruling with margin on left side, quad on right side. 192 pages. Black.

ORDER NUMBER	DESCRIPTION	UNIT
A44C.81	9¼"×7¼"	EA



F BLUELINE® OSTRICH NOTEPRO™ NOTEBOOK

Twin wire binding with a unique hard ostrich-like cover. NotePro™ has the durability of a hard cover and the flexibility of a wirebound book. Ruled pages with margin. Includes self-adhesive tabs, index sheet and storage pocket. Contains 50% post-consumer recycled paper. Black. FSC® certified.

ORDER NUMBER	DESCRIPTION	UNIT
A8C.81	9¼"×7¼", 192 pages	EA



G WINNABLE WIREBOUND NOTEBOOKS

Fabric soft cover with elastic band closure. Wirebound. 192 ruled pages.

ORDER NUMBER	DESCRIPTION	UNIT
1 56101	7¾"×5¾", Black	EA
2 56103	7¾"×5¾", Grey	EA
3 56104	7¾"×5¾", Purple	EA
4 56102	7¾"×5¾", Blue	EA



A BLUELINE® NOTEPRO™ PINK RIBBON NOTEBOOKS

Twin wire bound; self-adhesive tabs and storage pocket; 150 pages. Contains 50% post-consumer recycled paper. Refillable with MiracleBind™ sheets. FSC® Certified.

Blueline has proudly contributed over 1,000,000 to the Canadian Cancer Society in support of the breast cancer cause since 2007 from the sales of Pink Ribbon Products.

ORDER NUMBER	DESCRIPTION	UNIT
1 A7150-PNK5	9¼"×7¼", Pink Daisy cover NEW!	EA
2 A7150-PNK	9¼"×7¼", Pink cover	EA
3 A7150-BLK1	9¼"×7¼", Black cover	EA



C CAMBRIDGE® CITY™ BUSINESS NOTEBOOKS

Durable black poly cover with square accent colour on front. Features black twin wire coil binding and 15 lb. white bond, college ruled, perforated paper. 70 sheets.

ORDER NUMBER	DESCRIPTION	UNIT
1 43100-06016	9½"×6½"	EA
2 43100-06018	11"×9½"	EA



NEW!

E CAMBRIDGE® WORKSTYLE FASHION NOTEBOOK

Elevate your notetaking experience with a larger page size and higher sheet count. Hardcover with gold foil accents. Gold coil binding. Lined pages with ink bleed resistance. 304 pages. Navy Blue.

ORDER NUMBER	DESCRIPTION	UNIT
590155	8½"×6½"	EA

F CAMBRIDGE® WORKSTYLE NOTEBOOK

Soft recycled fabric cover. Coil bound with a case binding. 200 ruled pages. Blue.

ORDER NUMBER	DESCRIPTION	UNIT
1 590021	8½"×6"	EA
2 590023	5"×7½"	EA



B BLUELINE® NOTEPRO™ NOTEBOOKS

Twin wire binding with hard cover. Lies completely flat. With 192 ruled pages with margin. Includes self-adhesive tabs, index sheet and storage pocket. Refillable with MiracleBind™ sheets. FSC® certified.

Colours: **81** Black, **82** Blue, **83** Red, **84** Green, **46** Purple.

ORDER NUMBER	DESCRIPTION	UNIT
A9C.____	9½"×7¼", Specify colour	EA



D FILOFAX® CLASSIC PASTEL NOTEBOOKS

Pretty pastel, soft touch leather-look notebook with colour coordinated elastic closure and matching pastel indexes. Features full 360° opening cover with integral reinforcement, 4 moveable indexes, (one including storage pocket), ruler page marker, and 112 moveable cream-coloured ruled pages. Elastic closure.

ORDER NUMBER	DESCRIPTION	UNIT
1 B115051U	8¼"×5¾", Vista Blue	EA
2 B115052U	8¼"×5¾", Duck Egg	EA
3 B1151070U	8¼"×5¾", Stone	EA



G FILOFAX® NOTEBOOKS

Soft, tactile leather-look cover can be folded open by a full 360°. Features an index, storage pocket, page-marker and 112 ruled pages. Elastic closure. ½" capacity. 8 rings.

ORDER NUMBER	DESCRIPTION	UNIT
1 B115007U	8¼"×5¾", Black	EA
2 B115011U	8¼"×5¾", Fuchsia	EA

A OXFORD™ STONE PAPER NOTEBOOKS

Ultra smooth, tear-resistant sheets. Made from stone, not paper pulp. Water-resistant paper. Coilbound. 60 pages. Ruled with margin. Assorted colours.



ORDER NUMBER	DESCRIPTION	UNIT
161640E	8½"×5½"	EA

B CAMBRIDGE® WIREBOUND HARD COVER NOTEBOOK

Classic textured hard cover. Contains a minimum of 30% post-consumer recycled material. Poly pocket. 160 pages.



ORDER NUMBER	DESCRIPTION	UNIT
1 43100-59214	9½"×7¼"	EA
2 43100-59216	11"×8¾"	EA



NEW!

C FILOFAX® CONFETTI NOTEBOOKS

Gold foil accents to brighten everyone's day. Laminated hard cover. Twin wire binding. 112 pages. Ruled pages. Elastic closure

ORDER NUMBER	DESCRIPTION	UNIT
1 B115117U	8¼"×5¾", Charcoal	EA
2 B115118U	8¼"×5¾", Rose	EA



NEW!

D CAMBRIDGE® PROJECT NOTES BUSINESS NOTEBOOK

Professional notebooks with style. Contains a minimum of 30% post-consumer recycled material. Poly cover. Twin wire bound. Bungee closure. Project ruling. 160 pages. Black with white stripe.

ORDER NUMBER	DESCRIPTION	UNIT
43100-06990	9½"×7¼"	EA

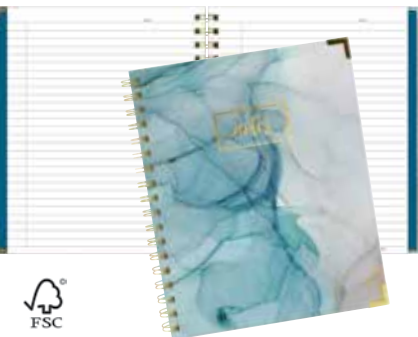

E BLUELINE® QUARTZ NOTEBOOK

FSC® Certified. Contains a minimum of 50% post-consumer recycled material. Gold twin wire bound. Two-piece hard cover with gold foil details. Micro-perforated sheets. Storage pocket. 180 pages. Turquoise.

ORDER NUMBER	DESCRIPTION	UNIT
A3890.01	9¼"×7¼"	EA



NEW!

F CAMBRIDGE® BUSINESS NOTEBOOKS

Side perforations for clean removal. Contains a minimum of 30% post-consumer recycled material. Twin wire bound. College ruled (½") paper. 80 sheets (160 pages). Black.

ORDER NUMBER	DESCRIPTION	UNIT
1 06672F	9½"×7½"	EA
2 06062F	11"×8½"	EA



NEW!

G FIVE STAR® TOP BOUND NOTEBOOK

Choose a notepad that keeps up with your busy day. Neat Sheet® perforated pages make it easy to tear out assignments. Water-resistant cover. Spiral Lock® wire binding. College ruled sheets. 200 pages. Black.

ORDER NUMBER	DESCRIPTION	UNIT
820045-22	8½"×11"	EA

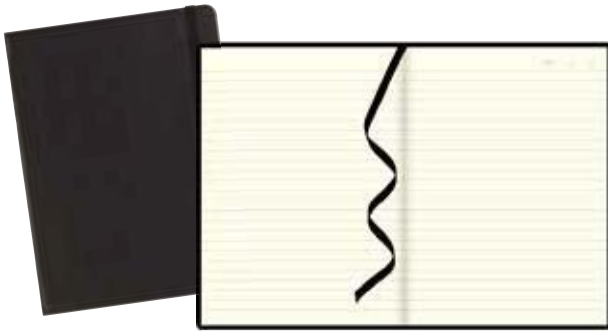

A LETTS® EDGE NOTEBOOK

Soft-touch, leather-look. Flexible cover. Perfect bound, sewn spine. Features cream coloured paper with rounded corners, elastic closure with ribbon bookmark and an expandable pocket. 192 pages. Ruled.

ORDER NUMBER	DESCRIPTION	UNIT
LEN5ERBK	8¼"×5¾", Black	EA

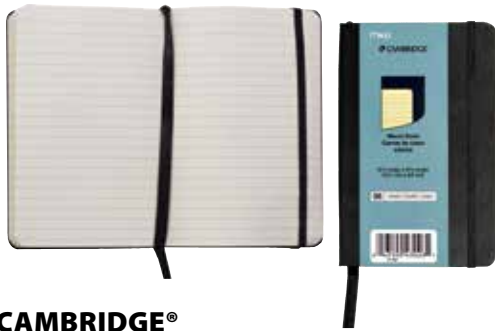

C CAMBRIDGE® BUSINESS MEMO NOTEBOOKS

Professional memo books in convenient mini and pocket sizes with hardbound black simulated leather cover. Premium cream coloured ruled pages; interior expandable storage pocket, bungee elastic closure and ribbon page marker.

ORDER NUMBER	DESCRIPTION	UNIT
1 43100-43026	5⅞"×3⅞", 192 pages	EA
2 43100-43030	4⅜"×2⅝", 192 pages	EA



E CAMBRIDGE® BUNGEE™ NOTEBOOKS

Fabric cover made from recycled materials. Features ruled pages, loop on spine to hold pen, and bungee closure. 192 pages.

ORDER NUMBER	DESCRIPTION	UNIT
1 590016	8½"×6", Charcoal EA	
2 590015	8½"×6", Lt. Grey EA	

OP
Our Savings Brand!

Our Brand, YOUR Savings !

B OP BRAND FLUSH CUT NOTEBOOK

Hard cover flush cut notebook. 192 ruled pages with margin. Black.

ORDER NUMBER	DESCRIPTION	UNIT
27811-50042	9"×7¼"	EA

D BLUELINE® NOTEBOOKS

Hard cover with perfect binding; contains 50% post-consumer recycled paper. Ruled pages. Includes self adhesive tabs (except A9S and A9X). Black or colours: **59** Red, **82** Blue, **84** Green.

ORDER NUMBER	DESCRIPTION	UNIT
1 A9_	9¼"×7¼", 192 pages, specify colour	EA
2 A9	9¼"×7¼", 192 pages, Black	EA
3 A9Q	9¼"×7¼", 192 pages, Quad, Black	EA



F BLUELINE® NOTEBOOKS

Bright colour with soft cover. Stitch bound. 64 pages. Ruled. Assorted colours.

ORDER NUMBER	DESCRIPTION	UNIT
A85	8¼"×5¾"	5/PK

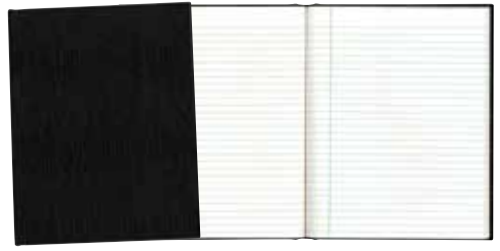

G BLUELINE® ECOLOGIX® NOTEBOOK

100% post-consumer recycled paper. 30% recycled cover. Ecologix® tips at the back of each notebook. Hard cover with glued binding, 150 pages. FSC® certified.

ORDER NUMBER	DESCRIPTION	UNIT
A7E.BLK	9¼"×7¼", Black	EA

OFFICE SUPPLIES

Notebooks and Pads



NEW!

A BLUELINE® EXECUTIVE JOURNAL

White paper, blue ruling and a ribbon bookmark. FSC certified. Contains a minimum of 50% post-consumer recycled materials. Perfect bound. Hard, lizard-like cover. 150 pages. Ruled with margin. Black.

ORDER NUMBER	DESCRIPTION	UNIT
A10.81	10¾"×8½"	EA



NEW!

B BLUELINE® FLEXI NOTEBOOKS

Soft flexible cover with rounded corners. Perfect bound. 144 pages. Ruled.

ORDER NUMBER	DESCRIPTION	UNIT
1 A7F.81	9¼"×7¼", Black	EA
2 A7F.82	9¼"×7¼", Blue	EA
3 A7F.83	9¼"×7¼", Red	EA



C BLUELINE® PASTEL NOTEBOOKS

FSC® Certified. Contains a minimum of 50% post-consumer recycled material. Perfect bound. Hard cover. Blue ruling with margin. 150 ruled pages. Pastel colours: **95** Rose, **96** Light Blue, **84** Sage or **89** Vanilla

ORDER NUMBER	DESCRIPTION	UNIT
A7L.____	9¼"×7¼"	EA



D WINNABLE ECO JOURNALS

Round corners with belly band closure. 100% recycled pages. Cover contains a minimum of 40% post-consumer recycled material. Ruled. Hard cover. Perfect bound. 192 pages.

ORDER NUMBER	DESCRIPTION	UNIT
1 ECO-21006	8½"×5½", Teal Blue	EA
2 ECO-21007	8½"×5½", Tan	EA

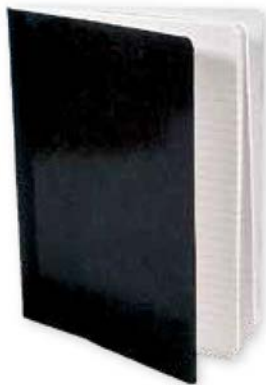

E HILROY COMPOSITION BOOK

Black, 200 ruled pages.

ORDER NUMBER	DESCRIPTION	UNIT
43100-09924	9¾"×7½"	EA



F WINNABLE® EXECUTIVE JOURNAL

With elegant textured leather-like padded and stitched cover, 20 lb. lined cream coloured paper. Ribbon bookmark and head and tail band. Black.

ORDER NUMBER	DESCRIPTION	UNIT
1 WJE-320-BK	9¾"×7", 320 pg	EA
2 WJE-118-BK	11"×8½", 152 pg	EA



NEW!

G BLUELINE® NOTEBOOK

Flush cover with white paper. Hard cover. Perfect bound. 192 pages. Ruled with margin. Black.

ORDER NUMBER	DESCRIPTION	UNIT
A19.81	9¼"×7¼"	EA



A HILROY COIL EXERCISE BOOKS

A 1/4" ruled (7 mm) exercise book with margin and 3-hole punching. 10 1/2" x 8".

ORDER NUMBER	DESCRIPTION	UNIT
1 65800-13121	80 page, Assorted colours	EA
2 65800-06331	80 page, Red NEW!	EA
3 65800-13129	100 page, Assorted colours	EA
4 65800-13223	250 page, Blue	EA
5 65800-13224	200 page, Assorted colours	EA
6 65800-06351	200 page, Blue NEW!	EA
7 65800-13111	108 page, 3 subject, Assorted colours	EA
8 65800-06361	108 page, 3 subject, Light Blue NEW!	EA
9 65800-13225	300 page, 3 subject, Assorted colours	EA
10 65800-06371	300 page, 3 subject, Blue NEW!	EA



D HILROY RULED NOTEBOOKS

Ruled pages with subject header, date and page number box. Index page printed on interior cover. Sticker page with tab divider and reminder stickers. Ruled. Coil bound. 10 1/2" x 8". Assorted colours.

ORDER NUMBER	DESCRIPTION	UNIT
65800-13048	200 pages	EA

E HILROY "CANADA" STITCHED EXERCISE BOOKS

Ideal for school and home use. Lightweight covers; assorted colours. 32 pages.



ORDER NUMBER	DESCRIPTION	UNIT
65800-12692	10 7/8" x 8 3/8"	4/PK

G HILROY GRAPH PAPER COILBOOKS

Three-hole punched, metric or imperial ruled. 10 1/2" x 8", 80 pages.



ORDER NUMBER	DESCRIPTION	UNIT
1 65800-66368	Metric, 1 cm square ruled	EA
2 65800-13222	Imperial, 4 squares/1"	EA



B HILROY RECYCLED NOTEBOOKS

Contains a minimum of 30% post-consumer recycled material. Coil bound and 3-hole punched. Ruled with a margin. Assorted colours.

ORDER NUMBER	DESCRIPTION	UNIT
65800-13040	10 1/2" x 8"	EA



C HILROY COIL NOTEBOOKS

Compact coilbound notebooks; 9 1/2" x 6", 1/4" ruled (7 mm) with margin.

ORDER NUMBER	DESCRIPTION	UNIT
1 65800-13401	100 pages, Blue	EA
2 65800-13400	200 pages, Green	EA
3 65800-13402	300 page, 5 subject, Assorted NEW!	EA
4 65800-06411	300 page, 5 subject, Green NEW!	EA



F FIVE STAR® COIL NOTEBOOKS

Perforated sheets for easy tear out. Planning guide with durable front/back covers.

ORDER NUMBER	DESCRIPTION	UNIT
1 43100-06040	11" x 8 1/2", 200 pages	EA
2 43100-06046	11" x 8 1/2", 400 pages, 5 subjects	EA
3 43100-06048	11" x 8 1/2", 300 pages, 3 subjects	EA



H HILROY POLY NOTEBOOKS

Lined pages with margins. One subject, college ruled white paper. Poly front cover. Assorted colours. 200 Pages.

ORDER NUMBER	DESCRIPTION	UNIT
65800-66182	10 1/2" x 8"	EA



A OP BRAND STENO NOTEBOOK

Feint narrow ruled with center line; flexible cardboard cover. Spiral bound at top; 120 pages.

ORDER NUMBER	DESCRIPTION	UNIT
27811-40006	6"×9"	EA

B BLUELINE® STENO NOTEBOOKS

Spiral bound in two formats. White paper with green ruling. 360 pages.



ORDER NUMBER	DESCRIPTION	UNIT
1 AT12B	6"×9", end opening, centre line	EA
2 AT35B	9"×6", side opening	EA



C HILROY COLOURHIDE NOTEBOOKS

Pen holder on the front cover, reusable ruler bookmark, cutout on cover to personalize notebook, and double sided pocket divider. Coil side bound. Polypropylene cover. Perforated, ruled pages.

ORDER NUMBER	DESCRIPTION	UNIT
1 450003-21	8¼"×6, 200 pg assorted colours	EA
2 450001-21	5"×8, 200 pg Navy Blue	EA
3 450002-21	5½"×4¼, 400 pg Aqua	EA

D HILROY 5-SUBJECT NOTEBOOK

Coil bound, side opening; heavyweight paper, feint ruled with centre line; manila divider sheets. 350 pages.



ORDER NUMBER	DESCRIPTION	UNIT
65800-53140	9½"×6"	EA

E HILROY STENO BOOKS

Spiral bound with centre line. 6"×9".



ORDER NUMBER	DESCRIPTION	UNIT
1 65800-53124	120 pg., White	EA
2 65800-53135	350 pg., White	EA

F WINNABLE® TOP-BOUND NOTEBOOK

Flexible cover; section sewn, bound at top; 200 ruled pages. Black.



ORDER NUMBER	DESCRIPTION	UNIT
W175-BK	3½"×6"	EA

G MEAD® POLY MEMO BOOK

Durable poly front and back covers. Wire binding at top, open end. Assorted colours.



ORDER NUMBER	DESCRIPTION	UNIT
1 43100-45602	3"×5", 100 sheets	EA
2 43100-45630	4"×6", 75 sheets	EA



H MEAD® MEMO BOOKS

Spiral bound pocket-sized notebooks in two sizes: 3"×5" (top or side opening, 60 sheets) or 4"×6" (top opening, 40 sheets).

ORDER NUMBER	DESCRIPTION	UNIT
1 43100-45534	Side opening, 5"×3", assorted	EA
2 43100-45354	Top opening, 3"×5", assorted	EA
3 43100-45464	Top opening, 4"×6", assorted	EA

I WINNABLE® SIDE-BOUND MEMO BOOKS

Flexible cover; sewn binding. Black.

ORDER NUMBER	DESCRIPTION	UNIT
1 W185-BK	6¾"×4", 96 p.	EA
2 W165-BK	7¾"×4¾", 192 p.	EA

J HILROY MEMO BOOK

Lightweight black cover; 56 pages.

ORDER NUMBER	DESCRIPTION	UNIT
65800-42370	5"×3"	EA

K FIVE STAR® FAT LIL' NOTEBOOK

Coil bound, feint ruled perforated sheets. Assorted colours; 400 pages.

ORDER NUMBER	DESCRIPTION	UNIT
43100-45388	5½"×4¾"	EA



A HILROY FIGURING PADS

Bond paper; stiff backing. Choice of white or canary in various sizes and rulings.

ORDER NUMBER	DESCRIPTION	UNIT
5"×8", 64 SHEETS		
1	65800-51941 Canary, narrow ruled	10/PK
2	65800-51041 Canary, narrow ruled	5/PK
LETTER SIZE, 8³/₈"×10¹/₈", 96 SHEETS		
3	65800-51240 White, narrow ruled	5/PK
4	65800-51250 White, wide ruled	5/PK
5	65800-51150 White, wide ruled	10/PK
6	65800-51254 White, wide ruled, 3-hole punched	5/PK
7	65800-51251 Canary, wide (80 sheets)	5/PK
8	65800-51270 White, quad, 4 squares/inch	5/PK
9	65800-51252 White, quad, 5 squares/inch	5/PK
LEGAL SIZE, 8³/₈"×14", 96 SHEETS		
10	65800-51440 White, quad, 4 squares/inch	5/PK
11	65800-51450 White, wide ruled	5/PK
12	65800-51451 Canary, wide ruled (90 sheets)	5/PK
TABLOID SIZE, 11"×17", 50 SHEETS		
13	65800-51072 White, quad, 4 squares/inch	2/PK

D HILROY NEWSPRINT WRITING PADS

Wide ruled (1/2"). 13 lb. 72 sheets per pad. 8³/₈"×10¹/₈". Canary.

ORDER NUMBER	UNIT
65800-51039	5/PK



Our Brand, YOUR Savings !



B OP BRAND FIGURING PADS
Letter size, 96 sheets per pad.

ORDER NUMBER	DESCRIPTION	UNIT
1	27811-40001 Ruled, 3/16"	5/PK
2	27811-40002 Quad ruled, 4/1"	5/PK



C CAMBRIDGE® MEETING NOTES WRITING PAD

Pad includes space for: date, topic, meeting objectives, attendees, notes, as well as specified space for actions. 20 lb. bond paper with micro-perforations. Contains a minimum of 30% post-consumer recycled material. 70 sheets. Stiff back. 8¹/₂"×11".



ORDER NUMBER	UNIT
65800-06410	EA

E HILROY SCRATCH PADS

The four most common plain white bond scratch pad sizes; 96 sheets, with a stiff backing.

ORDER NUMBER	DESCRIPTION	UNIT
1	65800-50305 3"×5"	10/PK
2	65800-50407 4"×6"	10/PK
3	65800-50509 5"×8"	10/PK

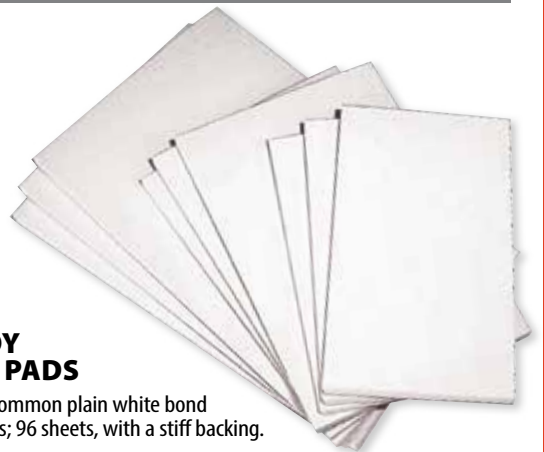



A AMPAD™ GOLD FIBRE™ WRITING PADS

Easy to remove micro-perforated sheets attached by heavy duty staples to an extra strong back. Sheets fold over without separating from pad. Extra-smooth, heavyweight white letter size paper.

ORDER NUMBER	DESCRIPTION	UNIT
20-830	College ruled, 3-hole punched, 70 sheets	EA

AMPAD™ FEATURE

B AMPAD™ PERFORATED WRITING PADS
Easy to remove micro-perforated sheets attached by heavy duty staples to an extra strong back. Sheets fold over without separating from pad. White, 50 sheets per pad.

ORDER NUMBER	DESCRIPTION	UNIT
1 20-368	Letter size, wide ruled	EA
2 20-366	Letter size, wide ruled, 3-hole punched	EA
3 20-367	Letter size, quad ruled, 4 squares/inch	EA



C HILROY ENVIRO-PLUS™ 100% RECYCLED WRITING PADS

Contains 100% post-consumer recycled material. Wide ruled (1½"). 8½"×11". 50 sheets per pad.

ORDER NUMBER	DESCRIPTION	UNIT
65800-51056	Wide ruled	5/PK



D CAMBRIDGE® COLOURED OFFICE PADS

Wide ruled (¾"). Premium 20 lb. bond paper. 8½"×11". 50 sheets per pad.

ORDER NUMBER	DESCRIPTION	UNIT
1 65800-59810	Orchid	3/PK
2 65800-59806	Blue	3/PK
3 65800-59804	Ivory	3/PK

E TOPS™ EARTHWISE™ BY AMPAD™ 100% RECYCLED PERFORATED WRITING PADS

Paper made with 100% post-consumer fibre. Dual purpose writing pad and desktop printer paper ruled one side, blank on back. Micro-perforated for clean sheet removal; can be used in inkjet printers.



ORDER NUMBER	DESCRIPTION	UNIT
1 40102	Letter size, wide ruled	4/PK
2 40112	Junior legal size – 5"×8", Medium ruled	6/PK



F CAMBRIDGE® PERFORATED PAD

Premium 20 lb bond paper with extra stiff back. Wide ruled perforated sheets. 5"×8". 50 sheets per pad, 3 pads/pkg.

ORDER NUMBER	DESCRIPTION	UNIT
65800-66370	White	3/PK

Accounting and Forms – columnar books

ALL BLUELINE® PRODUCTS ON THIS PAGE CONTAIN 50% POST-CONSUMER RECYCLED PAPER



A BLUELINE® A1740 COLUMNAR BOOKS

Perfect bound with durable hard bluecover. Green paper ruled with green and brown lines. With 80 numbered pages. **06** 6 columns, **08** 8 columns, **12** 12 columns, **18** 18 columns, **20** 20 columns. Specify number of columns.

ORDER NUMBER	DESCRIPTION	UNIT
A1740-__	12¼"×9⅞"	EA

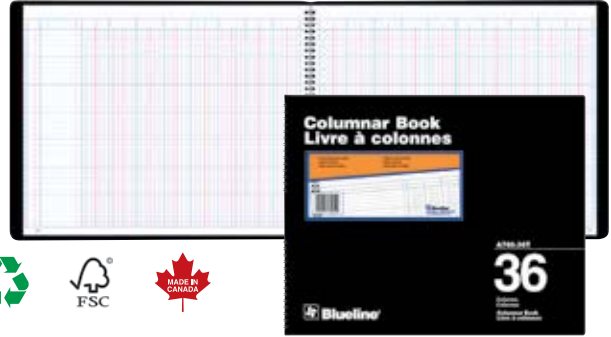

B BLUELINE® A769 LARGE COLUMNAR BOOKS

Twin wire binding with flexible black cover, 12"×15". With 80 numbered pages; white paper with red and blue rulings. **24** 24 columns, **30** 30 columns, **36** 36 columns. Specify number of columns.

ORDER NUMBER	DESCRIPTION	UNIT
A769-_T	12"×15"	EA

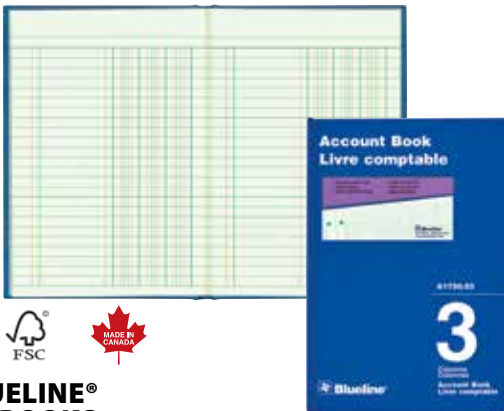

C BLUELINE® A1750 BOOKS

Perfect bound with hard blue cover. Green and brown rulings on green paper. 100 numbered pages. 3 columns.

ORDER NUMBER	DESCRIPTION	UNIT
A1750-03	8¼"×5⅝"	EA



D BLUELINE® ACCOUNTPRO™ ACCOUNT BOOKS

Durable hard cover with the flexibility of a wire bound book. White paper record books featuring numbered pages to ease referencing and to provide added security. Self-adhesive tabs and index sheets.

ORDER NUMBER	DESCRIPTION	UNIT
1 A796C-01	10¼"×7⅛", 200 pages	EA
2 A7963C-01	10¼"×7⅛", 300 pages	EA

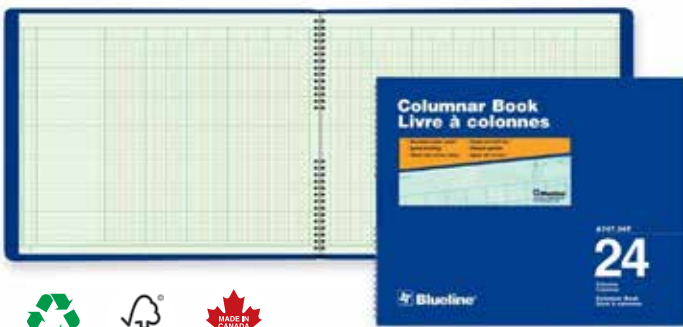

E BLUELINE® A747 COLUMNAR BOOKS

Twin wire binding with flexible blue cover. 80 numbered pages. Green tint paper. **24** 24 columns, **36** 36 columns. Specify number of columns.

ORDER NUMBER	DESCRIPTION	UNIT
A747-_T	12"×15"	EA

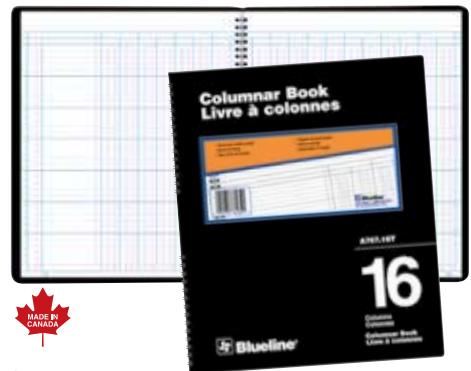

F BLUELINE® A767 COLUMNAR BOOKS

White paper with red and blue rulings. With 80 numbered pages. **04** 4 columns, **06** 6 columns, **08** 8 columns, **12** 12 columns, **16** 16 columns, **18** 18 columns, **20** 20 columns. Specify number of columns.

ORDER NUMBER	DESCRIPTION	UNIT
A767-_T	12"×10"	EA

Accounting and Forms – columnar books and ledgers

ALL BLUELINE® PRODUCTS ON THIS PAGE CONTAIN 50% POST-CONSUMER RECYCLED PAPER

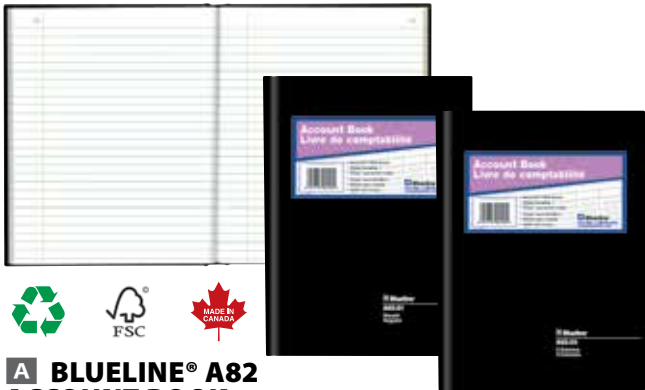

A BLUELINE® A82 ACCOUNT BOOK

Perfect bound with hard black cover; 10¼"×7⅛". With 112 numbered pages, ruled green and brown on white bond paper.

ORDER NUMBER	DESCRIPTION	UNIT
1 A82-01	Record	EA
2 A82-03	3 columns	EA



B BLUELINE® MINI LEDGER OUTFIT

6⅜"×10" rigid blue vinyl cover. Contains 100 sheets and A-Z index with 11-ring mechanism.

ORDER NUMBER	DESCRIPTION	UNIT
1 B055	Complete	EA
2 BS55	100 sheet refill (5⅝"×8½")	PK



C BLUELINE® A796 ACCOUNT BOOK

Perfect bound with hard black cover and reinforced hinges. Ruled green and brown on white bond paper. 10¼"×7⅛". 200 numbered pages.

ORDER NUMBER	DESCRIPTION	UNIT
A796-01	Record	EA

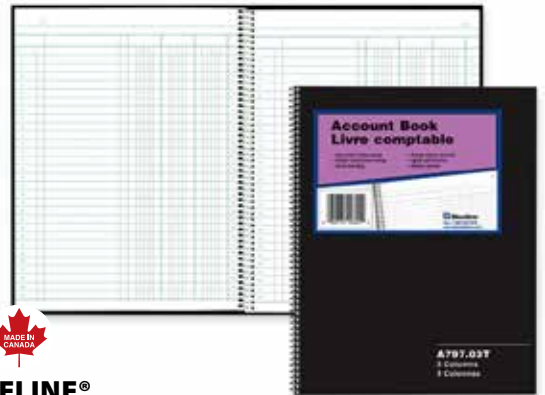

D BLUELINE® WIREBOUND ACCOUNT BOOK

Spiral binding with flexible black cover; 3 columns, 100 pages.

ORDER NUMBER	DESCRIPTION	UNIT
A797-03T	10¼"×8"	EA



E BLUELINE® 200 AND 300 PAGE ACCOUNT BOOKS

Perfect bound with hard black cover. White bond paper ruled in green and brown. Numbered pages. Choice of Record book (feint ruled, no columns), 3 columns. Page size 12½"×7⅞".

ORDER NUMBER	DESCRIPTION	UNIT
1 A790200-01	Record, 200 pages	EA
2 A790200-03	3 columns, 200 pages	EA
3 A790300-01	Record, 300 pages	EA

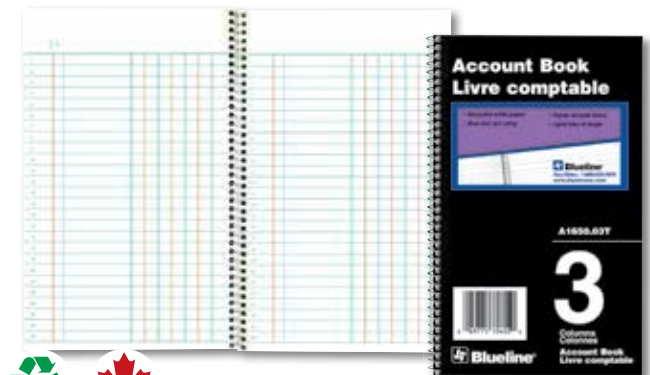

F BLUELINE® ACCOUNT BOOK

Spiral bound with flexible black cover with green and brown ruling. With 80 numbered pages, 8"×5".

ORDER NUMBER	DESCRIPTION	UNIT
A1650-03T	3 columns	EA

Accounting and Forms – columnar pads and payroll books

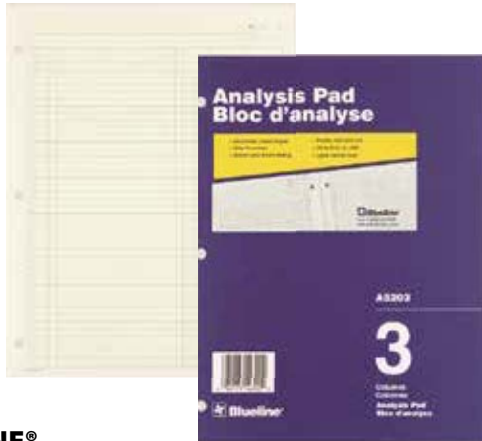

A BLUELINE® 5200 ANALYSIS PADS

Flexible blue cover. Green bond paper ruled in green and brown. 10 $\frac{1}{8}$ "×8 $\frac{1}{2}$ ". Fifty sheets per pad. Contains 50% post-consumer recycled paper.

ORDER NUMBER	DESCRIPTION	UNIT
1 A5203	3 columns	EA
2 A5204	4 columns	EA



B DEAN® PAYROLL PADS

Detailed employee statement sheets with space for recording hours worked, earnings and deductions designed to accompany payroll cheques.

ORDER NUMBER	DESCRIPTION	UNIT
1 81-200	100, 1 up, English	EA
2 81-201	100, 1 up, Bilingual	EA

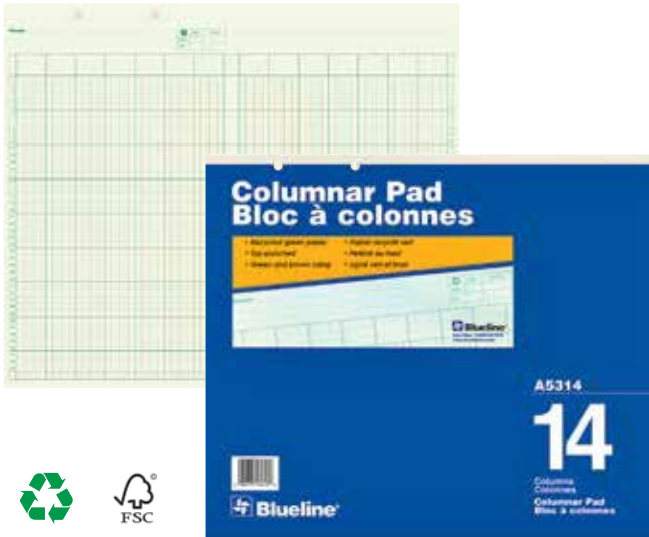

C BLUELINE® 5300 COLUMNAR PADS

Punched with 2 holes (2 $\frac{3}{4}$ " centre-to-centre). Ideal for working papers. Green tint paper ruled in green and brown. Flexible blue cover. 50 sheets per pad. Contains 50% post-consumer recycled paper.

ORDER NUMBER	DESCRIPTION	UNIT
1 A5307	7 columns, 8 $\frac{1}{4}$ "×14"	EA
2 A5314	14 columns, 16 $\frac{1}{2}$ "×14"	EA



D DEAN® PAYROLL BOOKS

A simple payroll book that records one complete year for each employee. Headings for all deductions are pre-printed. For up to 50 employees.

	ORDER NUMBER		DESCRIPTION	UNIT
	ENGLISH	BILINGUAL		
1	95-004	95-104	4 employees	EA
2	80-008	80-108	8 employees	EA
3	80-016		16 employees	EA
4	80-024		24 employees	EA
5	80-050		50 employees	EA

E BLUELINE® CHEQUE BINDER

Three ring cheque binder with $\frac{7}{8}$ " rings. Keep your cheques organized. Accommodates two cheques per page. 7"×11 $\frac{1}{4}$ ".

ORDER NUMBER	DESCRIPTION	UNIT
B10.81	Black	EA



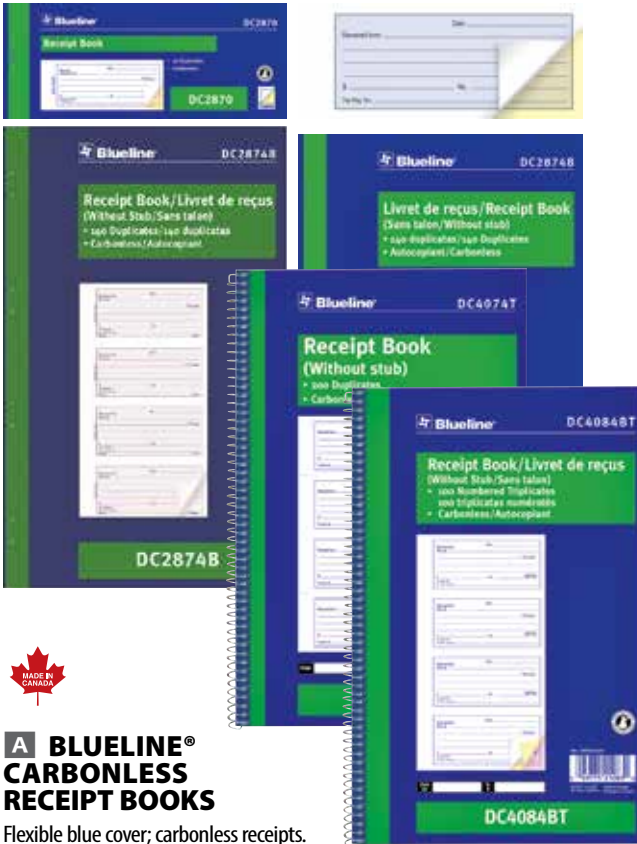

A BLUELINE® CARBONLESS RECEIPT BOOKS

Flexible blue cover; carbonless receipts. White original, yellow copies.

ORDER NUMBER	DESCRIPTION	UNIT
1 DC2870	50 dup., 1 up, 2¾"×6¾", English	EA
2 DCB2870	50 dup., 1 up, 2¾"×6¾", Bilingual	EA
3 DC2874B	200 dup., 4 up, 10⅞"×6¾", Bilingual	EA
4 DC2884	100 trip., 4 up, 11"×6¾", English	EA
WIREBOUND		
5 DC4074T	200 dup., 4 up, 10⅞"×6⅝", English	EA
6 DCB4074T	200 dup., 4 up, 10⅞"×6⅝", Bilingual	EA
7 DC4084BT	100 trip., 4 up, 10⅞"×6⅝", Bilingual	EA



D BLUELINE® SECURITY RECEIPT BOOKS

Carbonless, duplicate and numbered. Printed on safety tint paper; 1-up book contains 50 receipts, 4-up books contain 200 receipts.

ORDER NUMBER	DESCRIPTION	UNIT
1 DCB76	1 up, 2¾"×8", Bilingual	EA
2 DC74	4 up, 10⅞"×8", English	EA
3 DCB79	4 up, 10⅞"×8", Bilingual	EA



B BLUELINE® RECEIPT BOOKS

Receipts in books. White original, yellow copies. Bilingual printing.

ORDER NUMBER	DESCRIPTION	UNIT
1 A3074B	400 NCR duplicates, 4 up, 10¾"×8¼"	EA
2 A3084B	200 NCR triplicates, 4 up, 10¾"×8¼"	EA
3 A4074BT	200 NCR dup., 4 up, wirebound, 11"×6¾"	EA

C BLUELINE® RESTAURANT PADS

100 singles with stub per pad. 3⅝"×7½".

ORDER NUMBER	DESCRIPTION	UNIT
GAFA	Bilingual	10/PK



E BLUELINE® COUNTER SALES BOOKS

Fifty duplicate forms in each book. Carbonless; 3½"×6½", open end.

ORDER NUMBER	DESCRIPTION	UNIT
1 G3NCR.10	English	10/PK
2 G3NCR.10B	Bilingual	10/PK



A BLUELINE® CARBONLESS BUSINESS FORM BOOKS

Flexible blue cover. Clean, easy to use forms with large spaces for handwritten entries. Wrap around cover to provide a writing surface. Fifty pre-numbered forms in each book. Duplicate or Triplicate forms. English or Bilingual.

ENGLISH ORDER NUMBER	DESCRIPTION	BILINGUAL ORDER NUMBER	UNIT
----------------------	-------------	------------------------	------

SALES ORDERS

1	DC41	Duplicate, 3½"×6½"	DCB46	EA
2	DC42	Triplicate, 3½"×6½"	DCB47	EA
3	DC21	Duplicate, 5¾"×8"	DCB26	EA
4	DC22	Triplicate, 5¾"×8"	DCB27	EA
5	DC151	Duplicate, 8½"×11"	DCB156	EA
6		Triplicate, 8½"×11"	DCB157	EA
		invoices		
7	DC31	Duplicate, 5¾"×8"	DCB36	EA
8	DC32	Triplicate, 5¾"×8"	DCB37	EA
9		Triplicate, 8½"×11"	DCB177	EA

PURCHASE ORDERS

10	DC61	Duplicate, 5¾"×8"	DCB66	EA
11	DC62	Triplicate, 5¾"×8"	DCB67	EA
12	DC63	Triplicate, 8½"×11"	DCB68	EA



D BLUELINE® INTER-OFFICE MEMO FORM

Triplicate carbonless forms in snap sets. Designed as a round trip memo. Address space to fit a window envelope. Bilingual; 8½"×8"; 250 per box.

ORDER NUMBER	UNIT
A20B	BX



B BLUELINE® CARBONLESS BUSINESS FORM BOOKS

Flexible blue cover. Clean, easy to use forms with large spaces for handwritten entries. Wrap around cover provides a writing surface. Fifty pre-numbered forms in each book. Duplicate. Bilingual.

ORDER NUMBER	DESCRIPTION	UNIT
1	DCB56	Delivery Receipts, 4¼"×7"
2	DCB16	Requisitions, 4¼"×7"
3	DCB106	Statements, 5¾"×8"



C BLUELINE® TIME SHEETS WITH CARBON

Flexible blue cover; 5¾"×8". Contains 50% post-consumer recycled paper. 100 sheets. Bilingual.

ORDER NUMBER	UNIT
DB229	EA





A BLUELINE® AUTO RECORD BOOK

Weekly mileage log with space for maintenance and repairs each month. Travel diary, phone and address book. Black plastic cover protects the book. Bilingual printing; 108 pages. Contains 50% post-consumer recycled paper.

ORDER NUMBER	DESCRIPTION	UNIT
A1580-BLK	6 7/8"×3 1/2"	EA



B BLUELINE® DRIVER'S DAILY INSPECTION BOOK

The most complete vehicle verification book on the market. In line with new by-laws. Covers drivers and carriers. Easy and quick to fill in. Two carbonless copies. One sheet for every day of the month. Bilingual.

ORDER NUMBER	DESCRIPTION	UNIT
DCB252	5 7/8"×8"	EA

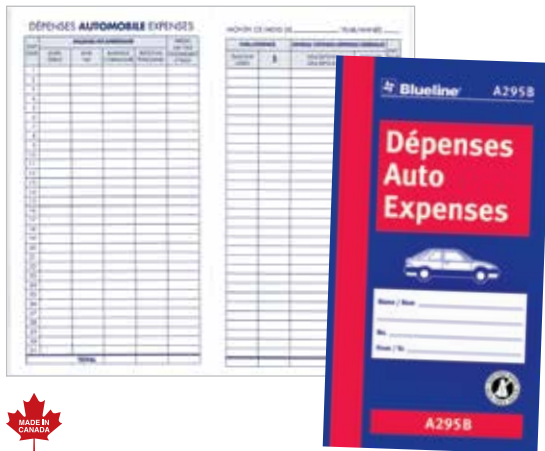

C BLUELINE® AUTOMOBILE EXPENSE BOOK

Compact book for detailing expenses. Ideal for storage in the glove compartment. Bilingual. Contains 50% post-consumer recycled paper.

ORDER NUMBER	DESCRIPTION	UNIT
A295B	6 3/8"×3 1/2", 32 pages	EA



D BLUELINE® SNAPSET GARAGE REPAIR FORMS

Consecutively numbered; 50 per package. Carbonless, 3-part. Bilingual.

ORDER NUMBER	DESCRIPTION	UNIT
DB4811	8 1/2"×11"	PK



E FORM-MATE CARBON PAPER

Black wax-based typing and pencil carbon paper; reusable.

ORDER NUMBER	DESCRIPTION	UNIT
1 65941-00007	8 1/2"×11 1/2"	12/EV
2 65941-00016	8 1/2"×11 1/2"	100/EV
3 10-1014	8 1/2"×14 1/2"	10/EV
4 65941-00002	8 1/2"×14 1/2"	100/EV

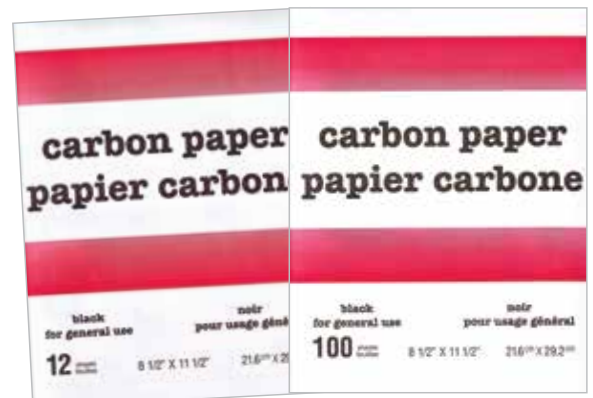

ALWAYS READY... when you are!



trodat[®]

CREATING ORIGINALS



A TRODAT® PRINTY 4911 CLIMATE-NEUTRAL SELF-INKING MESSAGE STAMPS

Small and lightweight with easy impression positioning. Contains up to 65% post-consumer recycled material. Non-toxic water-based ink. Limited lifetime warranty on mechanism. Maximum text plate size: 38 mm × 14 mm.

*Visit environment.trodat.net

ORDER NUMBER	DESCRIPTION	UNIT
--------------	-------------	------

ENGLISH

1	11410	Approved (with space for date)	EA
2	11600	Client Copy	EA
3	11315	Completed (with space for date)	EA
4	11327	Confidential	EA
5	11326	Copy	EA
6	11316	Draft	EA
7	11493	E-mailed (with space for date)	EA
8	11311	Entered (with space for date)	EA
9	11331	Faxed (with space for date)	EA
10	11317	File copy	EA
11	11337	For deposit only	EA
12	11305	Paid	EA
13	11306	Paid (with space for date)	EA
14	11340	Past due	EA
15	11350	Posted (with space for date)	EA
16	11304	Rush	EA
17	11333	Received (with space for date)	EA
18	97464TRO	Scanned	EA
19	11328	Urgent	EA
20	11357	Void	EA

BILINGUAL

21	11325	Original	EA
22	11380	Confidentiel	EA
23	11364	Copie	EA
24	97469	Par courriel (with space for date)	EA
25	11368	Payé (with space for date)	EA
26	11385	Pour dépôt seulement	EA
27	11369	Reçu (with space for date)	EA

REPLACEMENT INK PADS

28	67678	Blue	EA
29	67679	Red	EA



B TRODAT® S-PRINTY 4921 SELF-INKING MINI STAMPS

Non-toxic, water-based ink. Lifetime warranty on mechanism. Maximum text plate size: 12 mm × 12 mm.

ORDER NUMBER	DESCRIPTION	UNIT
--------------	-------------	------

1	11450	Copy	EA
2	11389	Happy face	EA
3	97463TRO	Large check mark	EA
4	11393	OK	EA
5	11391	Red circle	EA
6	11406	Red maple leaf	EA
7	97055	Thumb	EA

REPLACEMENT INK PADS

8	66974	Blue	EA
9	66973	Red	EA



C TRODAT® PRINTY 4911 CLIMATE NEUTRAL SELF-INKING I.D. PROTECTION STAMP

Contains up to 65% post-consumer recycled plastic. Protect yourself from identity theft. Just stamp over personal or confidential information with the "scrambled" impression. Non-toxic, water-based ink. Lifetime warranty on mechanism. Maximum text plate size: 38 mm × 14 mm.

ORDER NUMBER	DESCRIPTION	UNIT
--------------	-------------	------

1	97462TRO	Stamp	EA
2	67677	Replacement ink pad, black	EA



D TRODAT® 4911 SELF-INKING TEACHER STAMP

Ideal when sending homework home for parent's signature. Contains up to 65% post-consumer recycled material. Non-toxic water-based ink. Lifetime warranty on mechanism.



ORDER NUMBER	DESCRIPTION	UNIT
--------------	-------------	------

1	97057	Stamp	EA
2	67678	Replacement ink pad, Blue	EA

DEC 14 2030



DEC 14 2030
14 DEC. 2030



A TRODAT® 4810 PRINTY 3 mm DATER

Break-proof plastic with black inked pad; twelve-year band; character size: 3/8" (3 mm). Contains up to 70% recycled material. Lifetime warranty on mechanism.

ORDER NUMBER	DESCRIPTION	UNIT
1 70685	English	EA
2 70266	French	EA
3 69224	Replacement ink pad, Black	EA
4 69322	Replacement ink pad, Blue	EA
5 69324	Replacement ink pad, Red	EA

B TRODAT® 4820 PRINTY 4 mm DATER

Break-proof plastic with black inked pad; twelve-year band; character size: 5/8" (4 mm). Contains up to 70% recycled material. Lifetime warranty on mechanism.

ORDER NUMBER	DESCRIPTION	UNIT
1 74005	English	EA
2 74006	French	EA
3 67677	Replacement ink pad, Black	EA
4 67678	Replacement ink pad, Blue	EA
5 67679	Replacement ink pad, Red	EA



C TRODAT® 4750 PRINTY DATERS

Break-proof plastic with blue and red inked pad; twelve-year band. Contains up to 70% post-consumer recycled material. Lifetime warranty on mechanism. Maximum text plate size: 41 mm x 24 mm. Date size: 4 mm.

ORDER NUMBER	DESCRIPTION	UNIT
1 141083	Faxed	EA
2 143904	Received	EA
3 143905	Paid	EA
4 67809	Replacement ink pad, Blue/Red	EA

D TRODAT® 4850 PRINTY DATERS

Twelve-year band. Contains a minimum of 70% post-consumer recycled material. Lifetime warranty on mechanism. Maximum text plate size: 25 mm x 5 mm. Date size: 3.8 mm.

ORDER NUMBER	DESCRIPTION	UNIT
1 76753	Received	EA
2 76653	Reçu le	EA
3 76754	Paid	EA
4 76553	Replacement ink pad, Blue/Red	EA
5 97044	Replacement ink pad, Black	2/PK
6 4880	Replacement ink pad, Blue	2/PK
7 4882	Replacement ink pad, Red	2/PK

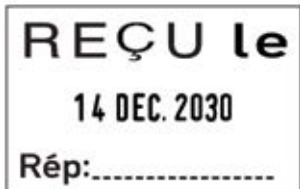

E TRODAT® 2210 DATERS

Sturdy steel frame; twelve-year band. Lifetime warranty on mechanism. Maximum text plate size: 47 mm x 30 mm. Date size: 4 mm.

ORDER NUMBER	DESCRIPTION	UNIT
1 28000	Received	EA
2 28001	Reçu le	EA
3 28002	Paid	EA
4 28003	Payé	EA

DEC 14 2030
28006

14 DEC. 2030
28007



F TRODAT® MANUAL DATERS

Sturdy steel frame; twelve-year band. Lifetime warranty on mechanism.

ORDER NUMBER	DESCRIPTION	UNIT
1 28006	English, 3 mm (1/8") date size	EA
2 28007	French, 3 mm (1/8") date size	EA
3 28008	English, 4 mm (5/32") date size	EA
4 28009	French, 4 mm (5/32") date size	EA
5 28010	English, 5 mm (3/16") date size	EA
6 28011	French, 5 mm (3/16") date size	EA

1 2 3 4 5 6



A TRODAT® TR-6 GOTHIC NUMBERING MACHINE

Six wheels; eight actions: 0×, 1×, 2×, 3×, 4×, 5×, 6× and 12×. Self-inking; includes two black ink cartridges and number changer. Character size: 5.5 mm.

ORDER NUMBER	DESCRIPTION	UNIT
1	27113 TR-6 numbering machine	EA
2	27053 Replacement ink pads, Black	2/PK

ORIGINAL COPY
E-MAILED
FIRST CLASS
CONFIDENTIAL

CONFIRMATION
CANCELLED
FAXED
DRAFT
APPROVED
URGENT!
ENTERED



B TRODAT® 4822 PRINTY PHRASE STAMP

Self inking; twelve different phrases. Contains up to 70% recycled material. Character size: 4 mm. Lifetime warranty on mechanism.

ORDER NUMBER	DESCRIPTION	UNIT
1	74046 English	EA
3	67677 Replacement ink pad, Black	EA
4	67678 Replacement ink pad, Blue	EA
5	67679 Replacement ink pad, Red	EA



OFFICE SUPPLIES

2 5 6 1 8 3
1 / 2 6 0
№ 6 7 8 9 0



C TRODAT® 4846 PRINTY NUMBERER

Ideal for numbering, coding and pricing. Six number bands, 3/2" characters. Contains up to 70% post-consumer recycled material. Character size: 4 mm. Lifetime warranty on mechanism.

ORDER NUMBER	DESCRIPTION	UNIT
1	73998 Numberer	EA
2	67677 Replacement ink pad, Black	EA

RECEIVED DEC 14 2030

ANSWERED
BACKORDERED
CANCELLED
BILLED
RECEIVED
EMAILED

CHECKED
DELIVERED
ENTERED
PAID
SHIPPED
FAXED



D TRODAT® 4817 PRINTY DIAL-A-PHRASE

Twelve phrases with date. Self inking. Stamp contains up to 70% recycled material. Character size: 3.8 mm. Lifetime warranty on mechanism.

ORDER NUMBER	DESCRIPTION	UNIT
1	80362 English	EA
2	80369 Replacement ink pad, Black	EA

2 5 6 1 8 3



E TRODAT® 1546 MANUAL NUMBERER

Six bands, characters 0-9 and various fractions and miscellaneous signs. Character size: 4 mm. Lifetime warranty on mechanism.

ORDER NUMBER	DESCRIPTION	UNIT
28014	Manual numberer	EA

RECEIVED DEC 14 2030

ANSWERED
CANCELLED
PAID
SHIPPED
ENTERED
COMPLETED
VOID

BILLED
RECEIVED
DELIVERED
FILED
APPROVED

F TRODAT® DIAL-A-PHRASE DATER

Prints 1/8" (3 mm) characters with twelve different status messages; 12-year date bands. Lifetime warranty on mechanism.

ORDER NUMBER	DESCRIPTION	UNIT
28012	English	EA



TRODAT® TYPO PRINTY CLIMATE NEUTRAL SELF-INKING CUSTOM PRINTING SETS

Make the templates you urgently need in just a few minutes. Each set includes one stamp with ribbed plate and locking device, ink pad, a set of 328, 3 mm (1/8") characters and a pair of tweezers. Contains a minimum of 65% post-consumer recycled material. Lifetime warranty on mechanism.



A TRODAT® 3-LINE CUSTOM PRINTING SET

Prints up to 17 letters per line, 3 mm (1/8").



ORDER NUMBER	DESCRIPTION	UNIT
1 67266	3-line set	ST
2 67677	Replacement ink pad, Black	EA



C TRODAT® 4-LINE CUSTOM PRINTING SET

Prints up to 21 letters per line, 3 mm (1/8"). Includes an additional set of 264, 4 mm (5/32") characters (prints up to 17 letters per line).



ORDER NUMBER	DESCRIPTION	UNIT
1 60419	4-line set	ST
2 97434	Replacement ink pad, Black	2/PK



E TRODAT® 5-LINE CUSTOM PRINTING SET

Prints up to 26 letters per line, 3 mm (1/8"). Includes an additional set of 264, 4 mm (5/32") characters (prints up to 21 letters per line).



ORDER NUMBER	DESCRIPTION	UNIT
1 67265	5-line set	ST
2 97435	Replacement ink pad, Black	2/PK



B TRODAT® 4922 SELF-INKING TEACHERS' STAMPS

Stamps are water-based and non-toxic.

ORDER NUMBER	DESCRIPTION	UNIT
1 05396	"Excellent"	EA
2 05398	"Good Homework"	EA
3 05399	"Much Improved"	EA
4 05420	"Outstanding"	EA
5 05422	"Very Good"	EA
6 97332	Replacement ink pad, Red (6/4922)	EA



D TRODAT® FELT STAMP PADS

Deliver clean, crisp impressions; re-inkable. Secure snap close lids.

ORDER NUMBER	DESCRIPTION	UNIT
1 56347	2 5/8" x 4 3/8", Black	EA
2 56344	2 5/8" x 4 3/8", Blue	EA
3 56346	2 5/8" x 4 3/8", Red	EA
4 56363	3 1/2" x 6 3/8", Black	EA
5 56360	3 1/2" x 6 3/8", Blue	EA
6 56362	3 1/2" x 6 3/8", Red	EA

F TRODAT® 7011 PREMIUM INK

Non-toxic, water-based ink for stamp pads.



ORDER NUMBER	DESCRIPTION	UNIT
1 55886	Black	EA
2 55883	Blue	EA
3 55885	Red	EA
4 55884	Green	EA



Good People, Who Know

To ensure that your order is processed correctly and efficiently, please fill this form out completely. One order per sheet; please photocopy form if necessary.

BILL TO:

Address: _____
 City: _____ Province: _____
 Postal Code: _____ E-mail: _____
 Attention: _____ Date: _____
 Tel.: _____ Fax: _____

Quote only Order

CUSTOMER BILLING INFORMATION:

Purchase Order Number: _____
 Cost Centre: _____
 Account Number: _____
 Customer Signature: _____
 All orders require a signature – this is authorization to process your order

SHIP TO:

Address: _____
 City: _____ Province: _____
 Postal Code: _____ E-mail: _____
 Attention: _____ Date: _____
 Tel.: _____ Fax: _____

TRODAT SELF-INKING PRINTY STAMPS



- 4910 3/8"×1"
- 4911 9/16"×1 1/2"
- 4912 3/4"×1 7/8"
- 4913 7/8"×2 1/4"
- 4915 1"×2 3/4"
- 4916 3/8"×2 3/4"
- 4921 1/2"×1/2"
- 4922 1 3/16"×1 3/16"
- 4923 1 3/16"×1 3/16"
- 4924 1 5/8"×1 5/8"
- 4926 1 1/2"×3"
- 4927 1 9/16"×2 3/8"
- 4928 1 5/16"×2 3/8"
- 9412 1 13/16"×5/8"
(black ink only)

Specify ink colour:

- Black Blue Red
- Green Blue/Red

TRODAT PROFESSIONAL LINE AND PRINTY DATERS



- 5430 1"×1 5/8"
- 5460 1 5/16"×2 1/4"
- 5470 1 9/16"×2 3/8"
- 5480 1 7/8"×2 3/4"
- 5415 1 3/4"
- 4750 1"×1 5/8"
- 4813* 1"×5/16"
- 48500* 1"×3/16"
- 4724 1 1/2"×1 1/2"
- 4727* 1 9/16"×2 3/8"

Specify ink colour:

- Black Blue Red
 - Green Blue/Red
- *Blue/Red not available

WOOD HANDLE RUBBER STAMPS

- D1 1/2"×1 3/8"
- D3 1/2"×2 5/8"
- D4 1/2"×2"
- D5 3/4"×3"
- D6 3/4"×3 1/2"
- D8 1"×2 1/2"
- D10 1"×1 3/4"
- D11 1 3/8"×2 1/2"
- D12 1 3/8"×3 3/4"
- D13 1 3/4"×1 3/4"
- D15 2 1/4"×2 1/4"
- D16 1 3/4"×3 3/4"
- D17 2 1/4"×3 3/4"

NON SELF-INKING DATERS

- 2910-P2 1 1/2"×2"
- 2910-P10 2"×2 3/4"
- 2910-P30 2" diameter
- 2910-P08 1 3/4"×2 1/2"
- 2910-12HR 2" diameter
- 2910-24HR 2" diameter



Quantity: _____ Product #: _____

PRINT IN CLEAR BLOCK LETTERS AS PER LAYOUT REQUIRED

CUSTOM SIGNATURE OR LOGO STAMPS AVAILABLE YOUR SIGNATURE HERE

Make your Trodat® Printy or Rubber Stamp a signature or logo stamp. Simply supply a copy of the signature or logo (scanned or suitable for scanning, or high resolution digital image) to fit the appropriate stamp.

SPECIFY FORMATTING

- ALL CAPS
- UPPER & lower
- lower case
- Sentence case

SPECIFY LAYOUT

- Centred copy
- Flush left
- Flush right
- Justified copy

SPECIFY FONT

- Helvetica
- Helvetica Italic
- Helvetica Bold
- Helvetica Bold Italic
- Times
- Times Italic
- Times Bold
- Times Bold Italic
- Cornet Script
- Brush Script
- Elegans Script
- Arial Black

TERMS AND CONDITIONS: Prices are net and include delivery. All prices are subject to change. Prices and specifications are subject to error. Since all items are made to customer specification, please ensure accuracy before placing order.

Binders and Covers – customizable ring binders



NEW!



A DAVIS GROUP™ EASYVIEW® CUSTOMIZABLE BINDERS

The front cover, spine, and back cover feature an ink transfer resistant clear overlay, allowing you to customize each binder and make it your own. Complete with clear interior front and back cover pockets for loose document security. Back mounted round rings allow pages to lie flat. PVC free polypropylene. 100% recycled board with 85% post consumer waste. Made in Canada. Colours: **05** Yellow, **07** Grey, **19** Orange, **24** Lime Green, **43** Pink, **52** Turquoise, **69** Purple, **92** Royal Blue.

ORDER NUMBER	DESCRIPTION	UNIT
1 8411-__-06	1", specify colour	EA
2 8412-__-06	1½", specify colour	EA
3 8413-__-06	2", specify colour	EA
4 8414-__-06	NEW! 3", specify colour	EA



B DAVIS GROUP™ QUICKFIT® VIEW BINDERS

Ink transfer resistant overlay on front cover, spine and inside pockets. Two interior pockets secure documents and allow for easy content identification. Binder insert wraps around spine to front cover for quick identification and easy insertion. Back mounted rings allow pages to lie flat. Available in Angle D Rings and Round Rings. Visit www.quickfitbinders.com for free insert templates. Made in Canada.

ORDER NUMBER	DESCRIPTION	UNIT
ROUND RING BINDERS Colours: 00 White, 01 Black.		
1 8700-__	5/8", specify colour	EA
2 8711-__	1", specify colour	EA
3 8712-__	1½", specify colour	EA
4 8713-__	2", specify colour	EA
5 8714-__	3", specify colour	EA

ORDER NUMBER	DESCRIPTION	UNIT
ANGLED RING BINDERS Colours: 00 White, 01 Black, 07 Grey, 72 Navy Blue.		
6 87A0-__	5/8", specify colour	EA
7 8701-__	1", specify colour	EA
8 8702-__	1½", specify colour	EA
9 8703-__	2", specify colour	EA
10 8705-00	3", White	EA
11 8705-01	3", Black	EA
12 8706-00	4", White	EA
13 8706-01	4", Black	EA
14 8707-00	5", White	EA
15 8707-01	5", Black	EA

OFFICE
SUPPLIES

Our Brand, YOUR Savings !



A OP BRAND CUSTOMIZABLE BINDERS

Made with environmentally friendly polypropylene – PVC free.

ORDER NUMBER	DESCRIPTION	UNIT
ROUND RING		
1	27811-20015 ½" ring, Black	EA
2	27811-20016 ½" ring, White	EA
3	27811-20017 1" ring, Black	EA
4	27811-20018 1" ring, White	EA
5	27811-20019 1½" ring, Black	EA
6	27811-20020 1½" ring, White	EA
7	27811-20021 2" ring, Black	EA
8	27811-20022 2" ring, White	EA
"D" RING		
9	27811-20007 1" ring, Black	EA
10	27811-20008 1" ring, White	EA
11	27811-20009 1½" ring, Black	EA
12	27811-20010 1½" ring, White	EA
13	27811-20011 2" ring, Black	EA
14	27811-20012 2" ring, White	EA
15	27811-20013 3" ring, Black	EA
16	27811-20014 3" ring, White	EA

OFFICE SUPPLIES

QuickFit BINDERS FEATURE



B DAVIS GROUP™ QUICKFIT® PRO HEAVY DUTY SINGLE TOUCH PIN-LOCK® VIEW BINDERS

This single touch, Pin-Lock®, gap free, locking D ring binder is made from PVC free polypropylene. The space saving double spine design allows all sizes to fit on a standard 12" shelf. Ink will not transfer to the clear overlay and inside pockets. The unique overlay design allows for front and spine customization with an 8½"×11" sheet of paper. Design your insert using the free software at www.quickfitbinders.com. Made in Canada. Colours: **0** White, **1** Black.

ORDER NUMBER	DESCRIPTION	UNIT
1	90010 1" ring, White	EA
2	90011DAV 1" ring, Black	EA
3	9002_ 1½" ring, specify colour	EA
4	9003_ 2" ring, specify colour	EA
5	9005_ 3" ring, specify colour	EA
6	9006_ 4" ring, specify colour	EA
7	90070DAV 5" ring, White	EA
8	90071 5" ring, Black	EA



C AVERY® DURABLE VIEW BINDERS

The DuraHinge design is stronger, lasts longer and resists tearing. DuraEdge makes the sides and top more pliable to resist splitting. Slant-D ring designed for smooth page turning. Durable construction is ideal for frequent reference. Non gapping ring feature prevents misalignment of rings. Wider front and back binder panels cover standard dividers and sheet protectors. PVC free. Visit avery.ca for free title page and spine insert templates for Microsoft® Word.

ORDER NUMBER	DESCRIPTION	UNIT
1	67933-34075 ½", White	EA
2	67933-34001 ½", Black	EA
3	67933-34002 1", White	EA
4	67933-34003 1", Black	EA
5	67933-34004 1", Navy	EA
6	67933-17021 1½", Black	EA
7	67933-17022 1½", White	EA
8	67933-17031 2", Black	EA
9	67933-17032 2", White	EA
10	67933-17041 3", Black	EA
11	67933-17042 3", White	EA
12	67933-17044 3", Navy	EA

Our Brand, YOUR Savings!



A OP BRAND ROUND RING BINDERS

Made with environmentally friendly polypropylene – PVC free.
With double trigger metal booster, two interior pockets and label holder.

ORDER NUMBER	DESCRIPTION	UNIT	
1	27811-20048	½", Black	EA
2	27811-20034	1", Black	EA
3	27811-20035	1", Blue	EA
4	27811-20036	1", Red	EA
5	27811-20037	1", Green	EA
6	27811-20038	1½", Black	EA
7	27811-20039	1½", Blue	EA
8	27811-20040	1½", Red	EA
9	27811-20041	1½", Green	EA
10	27811-20042	2", Black	EA
11	27811-20043	2", Blue	EA
12	27811-20044	2", Red	EA
13	27811-20045	2", Green	EA
14	27811-20046	3", Black	EA
15	27811-20047	3", Blue	EA



B OP BRAND "D" RING BINDERS

Slanted D-rings mounted on back cover allow material to always lie flat. Label holder on spine; two interior pockets. Made with environmentally friendly polypropylene – PVC free.

ORDER NUMBER	DESCRIPTION	UNIT	
1	27811-20028	1", Black	EA
2	27811-20029	1", Blue	EA
3	27811-20030	1½", Black	EA
4	27811-20031	1½", Blue	EA
5	27811-20032	2", Black	EA
6	27811-20033	2", Blue	EA
7	27811-20049	3", Black	EA
8	27811-20050	3", Blue	EA
9	27811-20027	4", Black	EA



C DAVIS GROUP™ DELUXE QUICKFIT® HEAVY DUTY FILE BINDERS

Extra-large wrap-around label can be printed on 8½"×11" paper. Finger hole in spine allows easy removal from shelf. Easy to load, time-saving back mounted Quickload rings (locking on 4" and 5" models) allow pages to lie flat. Ink transfer resistant, clear wraparound overlay; pockets on interior front and back cover. Commercial grade heavy duty polypropylene construction – designed for longevity and frequent reference; 100% recycled solid board with at least 85% post-consumer material. Create and print free customized inserts at www.quickfitbinders.com. Colours: **0** White, **1** Black.

ORDER NUMBER	DESCRIPTION	UNIT	
1	2803_	2" ring, specify colour	EA
2	2805_	3" ring, specify colour	EA
3	2806_	4" ring, specify colour	EA
4	2807_	5" ring, specify colour	EA



D DAVIS GROUP™ DELUXE QUICKFIT® HEAVY DUTY COMMERCIAL BINDERS

The space saving double spine design allows all sizes to fit on a standard 12" shelf. Quickload back-mounted rings have minimal curve for easy loading and allow pages to lie flat. Commercial grade heavy duty construction. Easy to use templates available at www.quickfitbinders.com. Black.

ORDER NUMBER	DESCRIPTION	UNIT	
1	29011	1" capacity	EA
2	29021	1½" capacity	EA
3	29031	2" capacity	EA
4	29051	3" capacity	EA
5	29061	4" capacity	EA
6	29071	5" capacity	EA

Binders and Covers – general purpose



A DAVIS GROUP™ ESSENTIAL BINDERS

Clear interior pockets on front and back covers secure loose documents. Full width label holder on spine. Colours: **00** White, **01** Black, **03** Red, **04** Green, **05** Yellow, **07** Grey, **08** Burgundy, **19** Orange, **24** Lime Green, **43** Pink, **52** Turquoise Blue, **69** Purple, **72** Navy, **92** Royal Blue.

ORDER NUMBER	DESCRIPTION	UNIT
ROUND RING		
1 2311-__	1", specify colour	EA
2 2312-__	1½", specify colour	EA
3 2313-__	2", specify colour	EA
4 2314-__	3", specify colour	EA

ORDER NUMBER	DESCRIPTION	UNIT
D RING NEW!		
5 2301-__	1", specify colour	EA
6 2304-__	2", specify colour	EA
7 2305-__	3", specify colour	EA

B AVERY® FLEXI-VIEW™ PRESENTATION BINDER

Flexible ½" binder with a stylish graphic border that makes your cover page stand out. Both outside and inside front covers are customizable; special material prevents ink and toner transfer. Durable, light-weight and easy to carry; 100-sheet capacity.

ORDER NUMBER	DESCRIPTION	UNIT
67933-15767	½", Black	EA



C VLB® FILEMODE POLY PRESENTATION BINDER

Durable cover with front pocket and customizable spine label.

ORDER NUMBER	DESCRIPTION	UNIT
20583-64823	1", Clear	EA



D ACCO® PRESSTEX® DATA BINDERS

Durable, moisture resistant covers with retractable sliding hooks for single point or suspension filing. Posts with a capacity of 6". Metal bindings with multiple position holes. For burst and unburst paper. Light Blue.

ORDER NUMBER	DESCRIPTION	UNIT
1 50505-54122	11"×8½"	EA
2 50505-54052	8½"×11"	EA
3 50505-54072	14¾"×11"	EA



8 1/2" x 5 1/2"

A DAVIS GROUP™ SPECIAL SIZED BINDERS

Rigid suede vinyl covers and inside front cover pocket. Spine label holder for easy file identification. Black; made in Canada.

ORDER NUMBER	DESCRIPTION	UNIT
9321-01	8 1/2" x 5 1/2", 1" capacity	EA



8 1/2" x 14"

C DAVIS GROUP™ LEGAL SIZE RING BINDERS

Four round rings, or 3 angle "D" rings to accommodate legal size (8 1/2" x 14") paper. Rigid suede vinyl covers and inside front cover pocket. Spine label holder. Black. Made in Canada.

ORDER NUMBER	DESCRIPTION	UNIT
1 9341-01	4 round rings, 1"	EA
2 9342-01	4 round rings, 1 1/2"	EA
3 9343-01	4 round rings, 2"	EA
4 9344-01	3 angle D rings, 2"	EA



B AVERY® 5 1/2" x 8 1/2" DURABLE VIEW BINDERS

Specialty size vinyl binder for 5 1/2" x 8 1/2" sheets. Round 1" ring prevents gapping and misalignment of rings. Two interior pockets.

ORDER NUMBER	DESCRIPTION	UNIT
1 67933-17116	White	EA
2 67933-17167	Black	EA

D DAVIS GROUP™ DELUXE QUICKFIT® HEAVY DUTY LEGAL SIZE VIEW BINDERS

Unique overlay design for 8 1/2" x 14" documents. Clear interior pockets on front and back covers. Ink transfer resistant overlay and inside pockets. Made in Canada. Create and print free customized inserts at www.quickfitbinders.com.

ORDER NUMBER	DESCRIPTION	UNIT
D RING		
1 95011P	Portrait, 1", Black	EA
2 95021P	Portrait, 1 1/2", Black	EA
3 95031P	Portrait, 2", Black	EA
ROUND RING NEW!		
4 95020L	Landscape, 1 1/2", White	EA

11" x 17"

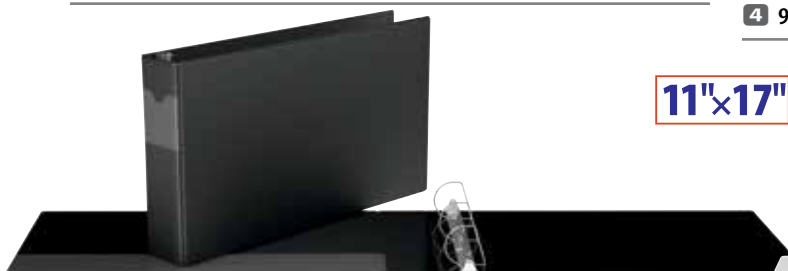

E DAVIS GROUP™ DELUXE HEAVY DUTY LEDGER (11" x 17") BINDERS

Back-mounted angle "D" rings allow pages to lie flat. Heavy duty construction. With label holder on spine and 5" pocket on inside front cover.

ORDER NUMBER	DESCRIPTION	UNIT
1 94111	1"	EA
2 94121	1 1/2"	EA
3 94131	2"	EA
4 94141	3"	EA



F DAVIS GROUP™ DELUXE QUICKFIT® HEAVY DUTY LEDGER (11" x 17") VIEW BINDERS

Unique overlay design allows you to create a one-piece custom insert from a single sheet that wraps around the spine and front cover. Back mounted rings allow pages to lie flat. Ink transfer resistant, clear wraparound overlay; pockets on interior front and back cover. Heavy duty polypropylene construction for longevity; 100% recycled solid board with at least 85% post-consumer material. Create and print free customized inserts at www.quickfitbinders.com. White.

ORDER NUMBER	DESCRIPTION	UNIT
1 94010	1", 225 sheet capacity	EA
2 94020	1 1/2", 350 sheet capacity	EA
3 94030	2", 475 sheet capacity	EA
4 94050	3", 625 sheet capacity	EA

Binders and Covers – specialty



A HILROY EXECUTIVE PROFESSIONAL BINDER

Professional binder with 1" double boosters ring. Features an expandable filing pocket, 2 document pockets, elastic pen loops, credit card slots, clear ID pocket, multi-function calculator and a 30 sheet ruled writing pad. 1" capacity. Black.

ORDER NUMBER	DESCRIPTION	UNIT
65800-29444	10¼"×13¾"	EA



B WINNABLE® LEATHER BINDER PORTFOLIO

Features an interior pocket, exterior document pocket and zippered closure. Includes writing pad. 1" rings. Letter size. Leather. Black.

ORDER NUMBER	DESCRIPTION	UNIT
PFL-237	13½"×11"×1½"	EA



C WINNABLE® EXECUTIVE BINDER PORTFOLIO

Features 2 document pockets and a zippered closure. Includes writing pad. 1" rings. Letter size. Koskin. Black.

ORDER NUMBER	DESCRIPTION	UNIT
PF-237II	13½"×10½"×1½"	EA



D HILROY CANADA ZIPPER BINDER

Chic and sophisticated. The front of the binder was made to replicate the look of traditional Hilroy notebooks. UV spot details on front of binder. Features 3 pocket expanding file, mesh pocket and pen loop on interior. 12½"×12½".

ORDER NUMBER	DESCRIPTION	UNIT
280007	1½" capacity	EA



E FIVE STAR® 3" ZIPPER BINDER

Keep it together with a zippered binder with interior document and calculator pockets. Convenient carrying handle. 3" D rings. 12½"×12½". Assorted colours.

ORDER NUMBER	DESCRIPTION	UNIT
43100-28018	3", assorted colours	EA



A HILROY RECYCLED REFILL PAPER

Contains 50% recycled material, 30% post-consumer content. 8½"×11", three-hole punched, college ruled.



ORDER NUMBER	UNIT
65800-05470	150/PK

C FIVE STAR® REINFORCED REFILL PAPER

Reinforced refill paper with triangular punched holes makes paper extra durable plus prevents paper from ripping out of binder. College ruled, heavyweight white paper. Fits into standard 3-ring binder. Page size is 10½"×8¾". 100 sheets per pack.



ORDER NUMBER	UNIT
43100-05000	100/PK

E FIVE STAR® REFILL PAPER

Premium heavyweight white, college ruled or quad paper. Standard binder size, three-hole punched.



ORDER NUMBER	DESCRIPTION	UNIT
1 43100-05237	Lined, 24 lb.	200/PK
2 43100-66376	Quad, 20 lb. 4/1"	100/PK



F AVERY® 5.5"×8.5" COLLEGE RULED FILLER PAPER

For smaller binders and organizers. High grade fine 20 lb. ruled paper, seven-hole punched, 100 per pack.



ORDER NUMBER	UNIT
77711-14230	100/PK



B HILROY REFILL PAPER

Three-hole punched paper.

ORDER NUMBER	DESCRIPTION	UNIT
1 65800-05233	10"×8", 7 mm Lined	200/PK
2 65800-05281	10"×8", 4/1"	50/PK
3 65800-05291	10"×8", 5/1"	50/PK
4 65800-66287	10"×8", 10/1" Metric ruled, 1 cm	100/PK
5 65800-05851	8"×5"	50/PK

D AVERY® REINFORCEMENTS

Strengthens and repairs standard-size punched holes. Permanent adhesive keeps labels in place for long-lasting reinforcement. Handy dispenser package peels each self-adhesive reinforcement off the roll one by one.



ORDER NUMBER	DESCRIPTION	UNIT
1 67933-02350	White	225/BX
2 67933-02352	Clear	250/BX



G GEMEX® PHOTO AND TRADING CARD REFILLS

Archival quality. All fit into standard 8½"×11" three-ring binder, except P464-10 which fits into a legal size binder or photo album.



ORDER NUMBER	DESCRIPTION	UNIT
1 P355-10	3½"×5" photos, 8 per page	10/PK
2 P46-10	4"×6" photos, 6 per page	10/PK
3 P57-10	5"×7" photos, 4 per page	10/PK
4 P464-10	4"×6" photos, 8 per page	10/PK
5 PH39-10	Trading cards, 9 per page	10/PK

Binders and Covers – accessories



A WINNABLE® SLANT BINDER POCKETS

Fits standard three-ring binders to hold sheets securely; 11¼"×9¼".

ORDER NUMBER	DESCRIPTION	UNIT
1 SP-02-CR	Clear	5/PK
2 SP-01-AD	Assorted	5/PK



B WINNABLE® TABBED BINDER POCKETS

Transparent polypropylene index divider tabs. Fits standard 3 ring binders. Includes inserts for tabs.

ORDER NUMBER	DESCRIPTION	UNIT
1 TP-55-AD	5 Colours	5/PK
2 TP-88-AD	8 Colours	8/PK

C PENDAFLEX® ESSENTIALS™ SLASH POCKET PROJECT FOLDERS

Diagonal cut provides fast access to papers. Features a CD pocket. Contains a minimum of 10% post-consumer recycled material. 11¼"×9¼". Assorted colours.



ORDER NUMBER	DESCRIPTION	UNIT
32940	Assorted	25/PK

D PENDAFLEX® WAVE™ POCKETS

Three-hole punched folder stock for ring binders. With die-cut pocket for holding small items such as CDs and business cards. Contains a minimum of 10% post-consumer recycled material. Assorted colours.



ORDER NUMBER	DESCRIPTION	UNIT
32900	Assorted	10/PK

E CARDINAL® EXPANDING ZIPPER BINDER POCKET

Use in or out of a binder. 3-hole punched strip tucks away when not in use. Non-stick poly expands ½". Holds up to 100 sheets. Letter size. Assorted colours.

ORDER NUMBER	UNIT
14650	5/PK



F WINNABLE® BINDER POUCH

Fits 3 ring binders. Poly with velcro closure and 1" expansion. Holds 20 sheets.



ORDER NUMBER	DESCRIPTION	UNIT
1 BP-12-CR	Clear	EA
2 BP-12-AD	Assorted	EA

G OXFORD® STASH-IT BINDER POKET™

Keeps small items safely stored inside binders. Extra durable, poly; expandable hook-and-loop fastener. Translucent design allows viewing of contents. Fits standard size three-ring binders; holds approximately 250 sheets of letter size paper.



ORDER NO.	DESCRIPTION	UNIT
98733C	Frosted	EA

Divide and Conquer.

Choose the right divider for the right job.



Avery® provides solutions that help you to divide and conquer!

Whether you're preparing a client presentation, assembling a training manual or outlining internal policies and procedures, you always want to create professional looking documents while still being efficient. Avery offers a wide selection of divider solutions to suit your need or budget.



Contemporary Ready Index



Clear Easy View Dividers



Index Maker



©2019 Avery Products Corporation. All rights reserved. Avery and all other Avery brands, product names and codes are trademarks of CCL Label, Inc. Personal and company names and other information on samples depicted are fictitious. Any resemblance to actual names and addresses is purely coincidental.



A OXFORD™ INSERTABLE INDEXES

Categorize documents in binders and reference information faster. Beaded tab design holds inserts securely in place. Reinforced binding edge. Three-hole punched, letter size.

ORDER NUMBER	DESCRIPTION	UNIT
1 R213-5A	5 tabs, assorted colours	ST
2 R213-5C	5 tabs, clear	ST
3 R213-8A	8 tabs, assorted colours	ST
4 R213-8C	8 tabs, clear	ST



B AVERY® BIG TAB INSERTABLE DIVIDERS

Special tab design secures inserts; bigger tabs and inserts – 50% more printing space. Dividers made from 20% post consumer recycled paper.

ORDER NUMBER	DESCRIPTION	UNIT
1 67933-11122	5 tab, clear	ST
2 67933-11124	8 tab, clear	ST



C OXFORD™ OVERSIZED TAB INSERTABLE INDEX DIVIDERS

Ideal for presentation binders. Large tabs ($\frac{3}{4}$ " wider and $\frac{1}{8}$ " taller than regular indexes) extend past page protectors for easy visibility. Letter size. Three-hole reinforced.

ORDER NUMBER	DESCRIPTION	UNIT
1 R215-5A	NEW! 5 tabs, assorted colours	ST
2 R215-5C	NEW! 5 tabs, clear	ST
3 R215-8A	8 tabs, assorted colours	ST
4 R215-8C	8 tabs, clear	ST



D OXFORD™ ERASABLE TAB INDEX DIVIDERS

Made from quality index card stock. Use the same tabs over and over again. Matte tab finish eliminates smudging. Tabs and binding edge are reinforced with clear, tear-resistant plastic. Paper made with 10% recycled fibre with at least 10% post-consumer fibre. White. Acid free SFI-certified.

ORDER NUMBER	DESCRIPTION	UNIT
1 WR213-5W	Letter, 5 tabs	ST
2 WR213-8W	Letter, 8 tabs	ST



E OXFORD™ SUBJECT DIVIDERS

Plain tab dividers, set of five assorted colours for easy reference. Paper made with 10% recycled fibre with at least 10% post-consumer fibre.

ORDER NUMBER	DESCRIPTION	UNIT
213-B	5 tabs	ST



F OXFORD™ PLAIN TAB DIVIDERS

Instant index tabs - no time consuming tab typing or insertion. Made from quality index stock. 3-hole punched. Letter size. White.

ORDER NUMBER	DESCRIPTION	UNIT
1 213-5W/1	5 tabs	ST
2 213-8W/1	8 tabs	ST



NEW!



A AVERY® BIG TAB™ WRITE & ERASE DIVIDERS

Feel large and in charge of your binder. Bigger tabs, 1½ times more writing space to enjoy. Made of sturdy paper for reusability. 11"×8½". White.

ORDER NUMBER	DESCRIPTION	UNIT
1 67933-23075	5 tab	ST
2 67933-23078	8 tab	ST



C AVERY® STYLE EDGE INSERTABLE DIVIDERS

Translucent plastic dividers feature a stylish multi-colour tab that has been designed to prevent inserts from falling out. Simply slide the insert under the tab. Laser and inkjet compatible; PVC free.

ORDER NUMBER	DESCRIPTION	UNIT
1 67933-11200	5 tabs	ST
2 67933-11201	8 tabs	ST



E AVERY® WRITE & ERASE BIG TAB™ DURABLE PLASTIC DIVIDERS

Durable poly dividers with writable/erasable surface (tab and body). Big tabs for 50% more writing space. PVC free; 11"×8½".

ORDER NUMBER	DESCRIPTION	UNIT
1 67933-16170	5 tabs	ST
2 67933-16171	8 tabs	ST

Our Brand, YOUR Savings!



B OP BRAND POLY INDEX DIVIDERS

Polypropylene index dividers with inserts. Multi-colour, 11"×8½".

ORDER NUMBER	DESCRIPTION	UNIT
1 27811-20055	5 tabs	ST
2 27811-20056	8 tabs	ST



D AVERY® BIG TAB™ ULTRALAST PLASTIC DIVIDERS

Ultra durable plastic won't rip or tear. Hand write or print on included tab labels with your laser or inkjet printer. Customize with free templates at www.avery.ca/print. Label, remove and reuse.

ORDER NUMBER	DESCRIPTION	UNIT
1 67933-24900	5 tab	ST
2 67933-24901	8 tab	ST



F AVERY® BIG TAB® INSERTABLE PLASTIC DIVIDERS

Organize binder documents for easy referencing. Oversized tabs to allow more space so you can use larger fonts or have more lines of text. Laser and inkjet compatible. 11"×8½". Assorted Translucent Colours.

ORDER NUMBER	DESCRIPTION	UNIT
1 67933-11901	8 tabs	ST
2 67933-11903	8 tabs with pockets	ST

Our Brand, YOUR Savings!



A OP BRAND COLOUR CODED INDEXES

Index page is colour-coded to match the preprinted multi-colour tabs. Tab titles can be photocopied or laser printed onto the index page. For laser printers or copiers; 8½"×11". Contains 20% post-consumer recycled material.

ORDER NUMBER	DESCRIPTION	UNIT
1 27811-20003	1-5	ST
2 27811-20004	1-8	ST
3 27811-20006	1-15	ST



C AVERY® READY INDEX® EASY EDIT DIVIDERS

Makes updates to table of contents pages quick and easy. Great for last-minute changes. Print the section titles onto a plain sheet of paper, three-hole punch the contents page and insert the sheet into the Easy Edit table of contents sleeve. Contents sleeve will not lift print. Dividers made from 20% post-consumer recycled paper. For laser or inkjet printers.

ORDER NUMBER	DESCRIPTION	UNIT
1 67933-11172	8 tabs	ST
2 67933-11173	10 tabs	ST



D AVERY® READY INDEX® DURABLE PLAIN TAB TABLE OF CONTENTS DIVIDERS

Multi-colour plain tabs, 6 sets/pk. Made from 20% post-consumer recycled paper.

ORDER NUMBER	DESCRIPTION	UNIT
1 67933-11518	5 tab	PK
2 67933-11519	8 tab	PK
3 67933-11520	10 tab	PK



B AVERY® READY INDEX® DURABLE TABLE OF CONTENTS DIVIDERS

Heavyweight paper stock, double-sided reinforced binding edge and extended reinforcement on divider tabs all provide additional durability. Tabs are printed to match – just fill in the table of contents page. Laser/inkjet; 20% post-consumer recycled content.

ORDER NUMBER	DESCRIPTION	UNIT
--------------	-------------	------

BLACK AND WHITE TABS

1 67933-11130	1-5	ST
2 67933-11132	1-8	ST
3 67933-11134	1-10	ST
4 67933-11140	1-12	ST
5 67933-11142	1-15	ST

COLOURED TABS

6 67933-11125	A-Z	ST
7 67933-11127	Jan.-Dec.	ST
8 67933-11131	1-5	ST
9 67933-11133	1-8	ST
10 67933-11135	1-10	ST
11 67933-11141	1-12	ST
12 67933-11143	1-15	ST
13 67933-11129	1-31	ST

COLOURED TABS, 6 SETS PER PACKAGE

14 67933-11187	1-5	6/PK
15 67933-11189	1-8	6/PK
16 67933-11188	1-10	6/PK

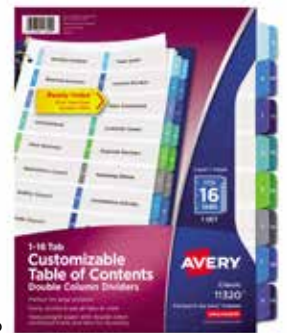

E AVERY® READY INDEX® DOUBLE COLUMN DIVIDERS

Table of contents with two columns. Heavyweight paper stock, double-sided reinforced binding edge and extended reinforcement on divider tabs all provide additional durability. Made from 20% post-consumer recycled paper.

ORDER NUMBER	DESCRIPTION	UNIT
1 67933-11320	16 tabs	ST
2 67933-11321	24 tabs	ST
3 67933-11322	32 tabs	ST



**A AVERY®
PRINT & APPLY CLEAR LABEL DIVIDERS**

For laser and inkjet printers. Print your own titles onto clear labels and apply labels to the supplied dividers to create a professionally printed look for ring binders. Easy Apply™ label sheets allow you to align and apply a full set of tab dividers at once; no need to apply each label individually. Dividers made from 20% post-consumer recycled paper.

ORDER NUMBER	DESCRIPTION	UNIT
1 67933-11446	5 tabs, white	25/BX
2 67933-11447	8 tabs, white	25/BX

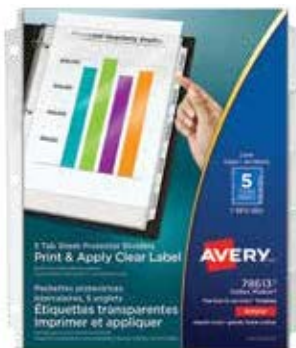

**C AVERY®
PRINT & APPLY CLEAR LABEL VIEW DIVIDERS**

Five clear pockets with clear tabs and clear labels for you to customize the look of your binder.

ORDER NUMBER	DESCRIPTION	UNIT
77711-78613	5 tab	ST



OP
Our Savings Brand!

Our Brand, YOUR Savings!



20001
OP
Clear Savings Brand!
Printable Tab Indexes
Onglets d'index imprimables



20002
OP
Clear Savings Brand!
Printable Tab Indexes
Onglets d'index imprimables

**B OP BRAND
PRINTABLE TAB INDEXES**

Printable white paper labels allow easy customization of index tabs. For laser printers and copiers. Contains 20% post-consumer recycled material.

ORDER NUMBER	DESCRIPTION	UNIT
1 27811-20001	5 tabs	5 SETS/PK
2 27811-20002	8 tabs	5 SETS/PK



**D AVERY® CLEAR EASY
VIEW DURABLE PLASTIC DIVIDERS**

No tab inserts or labels necessary. Durable, clear plastic dividers and sheet protector work together to provide a clean professional look and the flexibility to easily make changes or reuse dividers. Print titles on a plain sheet of paper and insert into the sheet protector. Place sheet protector as last page of your binder.

ORDER NUMBER	DESCRIPTION	UNIT
1 67933-16740	5 tab	ST
2 67933-16741	8 tab	ST

**E AVERY® READY INDEX® CUSTOMIZABLE
TABLE OF CONTENTS DIVIDERS**

Contemporary look with arched shape tabs. Extended tab reinforcement, double sided hole reinforcement and heavyweight paper prevents tearing and adds durability. Print or write on the table of contents and photocopy to create multiple sets of professional indexes. Double-sided contents sheet offers the flexibility to use in either portrait or landscape orientation. Laser and inkjet compatible. 11"×8½".

ORDER NUMBER	DESCRIPTION	UNIT
1 67933-11840	1-5	ST
2 67933-11841	1-8	ST
3 67933-11842	1-10	ST
4 67933-11843	1-12	ST
5 67933-11845	1-15	ST
6 67933-11846	1-31	ST
7 67933-11844	A-Z	ST
8 67933-11847	Jan.-Dec., bilingual	ST



A CARDINAL® ONESTEP® PRINTABLE INDEX SETS

Instantly create custom index sets by printing onto the two column Table of Content sheets. Matching, preprinted tabs on the divider sheets can be used vertical or landscape. Multi-colour tab sets have coordinating multi-colour Table of Content sheets. Reinforced tabs and ring edges. Laser and inkjet compatible. Three hole-punched. 11"×8½". White with colour tabs.

ORDER NUMBER	DESCRIPTION	UNIT
60990	Weekly, 52 tabs	ST



NEW!

B OXFORD® PREPRINTED POLY INDEX DIVIDERS

Dividers are made of acid-free polypropylene. The tabs are preprinted on both sides in large, bold type. 11"×8½". White.

ORDER NUMBER	DESCRIPTION	UNIT
1	PL213-31W 1-31	ST
2	PL213W A-Z	ST
3	PL213-12W JAN-DEC	ST

C OXFORD™ WHITE PRINTED TAB INDEXES

Preprinted tabs for quick and efficient referencing. Tab titles are printed in bold large type on both sides. Tabs and binding edge reinforced with tear-resistant clear plastic. Paper made with 10% recycled fibre with at least 10% post-consumer fibre. SFI-certified. White. Letter size.

ORDER NUMBER	DESCRIPTION	UNIT
1	CR213-10W 1-10	ST
2	CR213-50W 1-50	ST
3	CR213-100W 1-100	ST

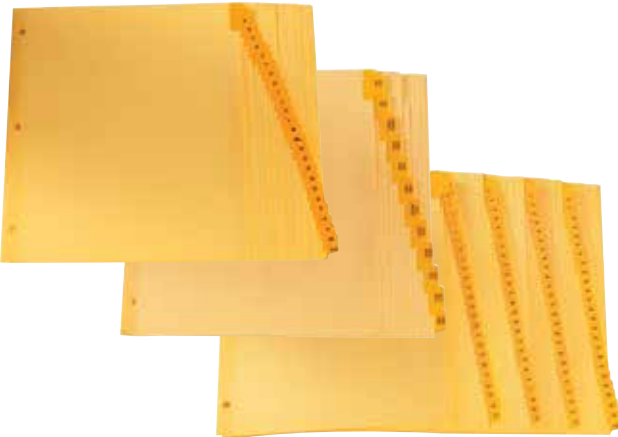

D OXFORD™ PREPRINTED LOOSELEAF INDEXES

High quality, buff colour indexes. Tabs printed in bold type, both sides. Plastic reinforced binding edge and tab. Paper made with 10% recycled fibre with at least 10% post-consumer fibre. SFI-certified. Letter size.

ORDER NUMBER	DESCRIPTION	UNIT
1	CR213 A-Z	ST
2	CR213-12 JAN-DEC, Bilingual	ST
3	CR213-10B 1-10	ST
4	CR213-25 1-25	ST
5	CR213-31 1-31	ST
6	CR213-50N 1-50	ST
7	CR213-100N 1-100	ST



E LEGAL EXHIBIT INDEX DIVIDERS

Buff, 11"×8½"; 25 per package.

ORDER NUMBER	DESCRIPTION	UNIT
1	ITC_ Single letter, specify (A–W)	PK
2	ITCXYZ X, Y and Z	PK
3	ITC_ Single numeral, specify (1–100)	PK
4	ITCINDEX Index	PK

COLLATED NUMBERS

5	ITC01-25 1-25	ST
6	ITC26-50 26-50	ST
7	ITC51-75 51-75	ST
8	ITC76-100 76-100	ST
9	ITC101-125 101-125	ST
10	ITC126-150 126-150	ST
11	ITC151-175 151-175	ST
12	ITC176-200 176-200	ST

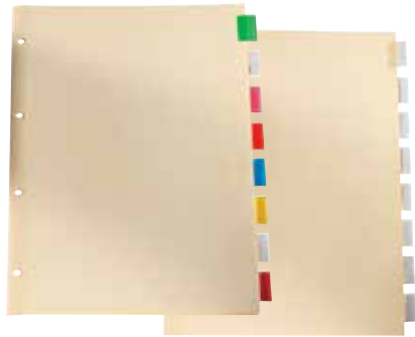

A OXFORD™ INSERTABLE LEGAL SIZE INDEXES

High quality buff index stock. Tab design holds included inserts securely. Reinforced four-hole punched. 14"×8½".

ORDER NUMBER	DESCRIPTION	UNIT
1 R217-8A	Assorted colours	ST
2 R217-8C	Clear	ST



B CARDINAL® 11"×17" TABLOID SIZE WRITE 'N ERASE® TAB DIVIDER

Coated tabs are eraseable with any pen or non-permanent marker. Erase and reuse.

ORDER NUMBER	DESCRIPTION	UNIT
1 84270	White, 5 tabs	ST
2 84271	White, 8 tabs	ST

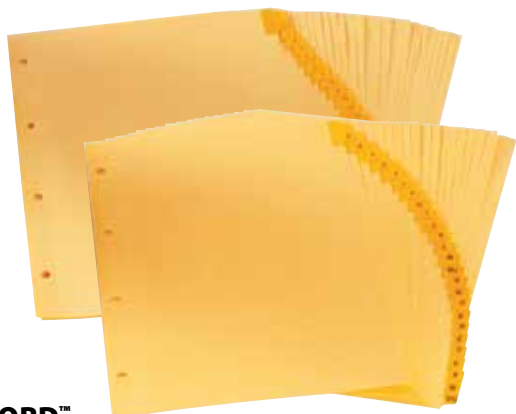

C OXFORD™ PREPRINTED LEGAL SIZE INDEXES

High quality buff colour indexes. Tabs printed in large bold type, both sides. Plastic reinforced tabbing and edge. Paper made with 10% recycled fibre with at least 10% post-consumer fibre. Legal format, 14"×8½".

ORDER NUMBER	DESCRIPTION	UNIT
1 CR217	A-Z	ST
2 CR217-31	1-31	ST

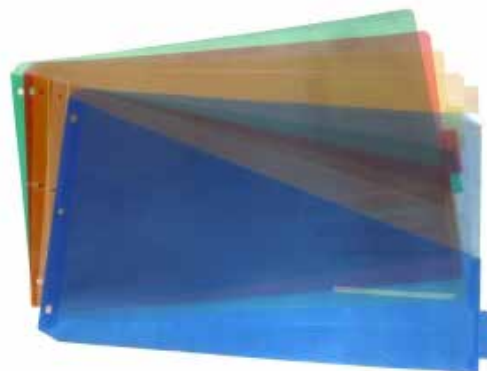

D VLB® FILEMODE 11"×17" INDEX DIVIDERS

Index dividers with inserts; 5 tabs.

ORDER NUMBER	DESCRIPTION	UNIT
20583-30218	Poly, assorted colours	ST

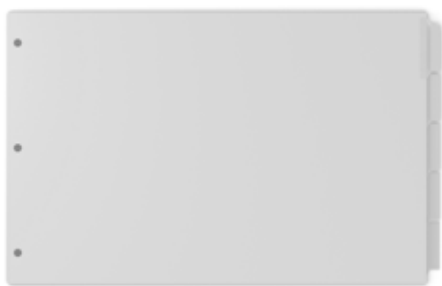

E DAVIS GROUP™ LANDSCAPE FORMAT INDEX SETS

Features a reinforced spine edge. Contains a minimum of 30% post-consumer recycled material. Clear tabs.

ORDER NUMBER	DESCRIPTION	UNIT
1 64200	8½"×11", 5 tabs	ST
2 63200	8½"×14", 5 tabs	ST
3 62200	11"×17", 5 tabs	ST



F AVERY® DURABLE WRITE-ON DIVIDERS

Durable poly dividers with writable/erasable surface (tab and body). Big tabs for 50% more writing space. PVC free. 5 tabs.

ORDER NUMBER	DESCRIPTION	UNIT
67933-16180	5½"×8½"	ST

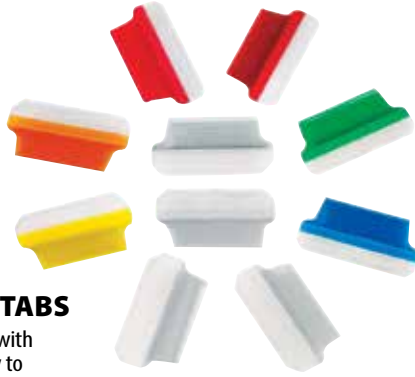

A OXFORD™ SELF-ADHESIVE TABS

Pre-cut self-adhesive tabs with white inserts. Easy to apply to dividers/pages. Backing paper protrudes beyond skirt for ease of use.

ORDER NUMBER	DESCRIPTION	UNIT
1 15A	1.5" Assorted	10/PK
2 15C	1.5" Clear	10/PK



C POST-IT® DURABLE TABS

Ideal for long-term filing or projects. Large 1"×1½" writing surface; 22 tabs per pad, three pads per pack.

ORDER NUMBER	DESCRIPTION	UNIT
1 686L-GBR-B	Green, Blue, Red	66/PK
2 686L-PGO-B	Pink, Green, Orange	66/PK



D POST-IT® TABS & FLAGS COMBO PACK

Highlight what's important wherever you are! This handy portable pack helps call attention to specific information on-the-go. Includes 5 dispensers of ½" flags and 3 dispensers of 1" tabs. Assorted colours. 8 dispensers/pk.

ORDER NUMBER	UNIT
686-COMBO1-EF	PK

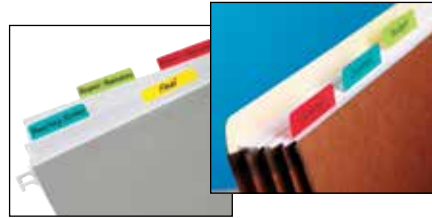

B POST-IT® FILING TABS

Durable, writable tabs with Post-it® adhesive are repositionable, stick securely and remove cleanly. Great for organizing file folders or for binders, planners and notebooks. White or assorted primary colours. 2"

ORDER NUMBER	DESCRIPTION	UNIT
1 686-24WE-C	White	24/PK
2 686-ALYR-C	Red, Yellow, Green, Blue	24/PK



E POST-IT® DURABLE INDEX TABS

Durable tabs make it easy to quickly organize binders, notebooks, planners and more! Easy to write on and simple to remove and reposition.

ORDER NUMBER	DESCRIPTION	UNIT
1 686-RYB	1" Red, Yellow, Blue	66/PK
2 686-PGO	1" Pink, Green, Orange	66/PK
3 686-FLOPBT	1" Foil Optimistic Brights	36/PK
4 676-AYPV	¾" Aqua, Yellow, Pink, Violet	40/PK



A HILROY ENVIRO PLUS™ REPORT COVERS

Three-rivet clasps hold standard three hole punched paper in place. Embossed Hilroy design on fronts. Contains 100% recycled material, 30% post-consumer. Colours: **28** Red, **36** Yellow, **48** Blue, **50** Green.

ORDER NUMBER	DESCRIPTION	UNIT
65800-068__	Specify colour	25/BX



C OXFORD® PANEL ANDBORDER REPORT COVER

Embossed panel and border front with label area. Holds up to 100 sheets of 3-hole punched paper, 11"×8½". Paper made with 10% recycled fibre with at least 10% post-consumer fibre. Acid free.

ORDER NUMBER	DESCRIPTION	UNIT
--------------	-------------	------

BOX COLOURS:

01 Light Blue, **02** Blue, **03** Light Green, **06** Black, **11** Red, **38** Dark Blue

1 525__	Specify colour	25/BX
2 62505	Grey	25/BX
3 62509	Yellow	25/BX

6-PACK COLOURS:

02 Blue, **05EE** Grey, **56** Red, **57** Green, **58** Light Blue, **59** Dark Blue, **60** Black

4 565__	Specify colour	6/PK
5 66509	Yellow	6/PK



B ACCO® REPORT COVERS

Pressboard cover with flexible steel fasteners. With 60% recycled content & 30% post-consumer material content. Colours (11"×8½" only): **1** Black, **2** Blue, **3** Royal Blue.

ORDER NUMBER	DESCRIPTION	UNIT
1 A7017921	8½"×11", Black	EA
2 A7019921A	8½"×14", Black	EA
3 A7030071A	14"×8½", Black	EA
4 A7047071A	11"×17", Black	EA
5 A702597_A	11"×8½", specify colour	EA



D WINNABLE® CLAMP BINDER

Clear, letter size; ½" capacity.

ORDER NUMBER	DESCRIPTION	UNIT
BDR-01-CR	Clamp binder	EA



Binders and Covers – report covers



A OXFORD® CLEAR FRONT TANG REPORT COVER

Clear acetate front cover gives view of entire title page. Holds up to 100 sheets of 3-hole punched paper. Leatherette grained stock. Paper made with 10% recycled fibre with at least 10% post-consumer fibre. Acid free. Colours: **01** Light Blue, **06** Black, **11** Red, **38** Dark Blue, **56** Green.



ORDER NUMBER	DESCRIPTION	UNIT	1-24	25
558__	Specify colour	EA		

**HOLDS UP TO
80 LETTER SIZE SHEETS**



B WINNABLE® CLEAR FRONT POLY REPORT COVER

Sturdy 3-prong fastening. Clear cover allows identification of contents. Holds up to 80 letter size sheets. Colours: **BK** Black, **DB** Dark Blue, **RD** Red.

ORDER NUMBER	DESCRIPTION	UNIT
TCC-05-3__	Specify colour	3/PK



C WINNABLE® POLY TANG REPORT COVERS

Holds 8½"×11" documents, 80 sheet capacity. Translucent colours: **BE** Blue, **CR** Clear, **GN** Green, **RD** Red.

ORDER NUMBER	DESCRIPTION	UNIT
1 TC-02-__	Specify colour	EA
2 5TC-02-CR	Clear	5/PK



D GEMEX® PRESENTATION COVERS

Transparent vinyl cover for use with non-punched pages. Choose the appropriate size spine to prepare an attractive report quickly and economically. Letter size. Clear.



ORDER NUMBER	DESCRIPTION	UNIT
1 PC-527-C25		25/BX
2 PC-527-C		100/BX



E GEMEX® COVER SPINES

For presentation covers listed above. Slide-on spine grips contents securely. Package of 25. Colours: **BK** Black, **W** White.



ORDER NUMBER	DESCRIPTION	UNIT
1 TB11-4__	Letter, ¼", specify colour	25/PK
2 TB11-8__	Letter, ½", specify colour	25/PK



**A OXFORD®
TWIN POCKET PORTFOLIO WITH TANGS**

Leatherette embossed cover with twin pockets, die-cut business card holder and fasteners. Holds 135 sheets of letter size paper (85 in fastener; 25 per pocket). Paper made with 10% recycled fibre with at least 10% post-consumer fibre. Acid free. Colours: **01** Light Blue, **02** Dark Blue, **03** Green, **06** Black, **11** Red.



**B WINNABLE®
TWIN POCKET PORTFOLIO WITH TANGS**

Features two pockets, three sturdy prong fasteners and a business card holder on the inside; 11"×9½".

ORDER NUMBER	DESCRIPTION	UNIT
577_	Specify colour	EA

ORDER NUMBER	DESCRIPTION	UNIT
1 TCP-04-3BK	Black	3/PK
2 TCP-04-3DB	Dark blue	3/PK



C OXFORD® TWO POCKET POLY PORTFOLIO WITH TANGS

Durable polypropylene construction makes this portfolio tear and moisture resistant. Twin pocket folder holds 135 letter size sheets. Colours: **22** Black, **23** Orange, **24** Green, **25** Red, **26** Blue, **27** Yellow, **28** Purple.

ORDER NUMBER	DESCRIPTION	UNIT
760_	Specify colour	EA



D GBC® SWINGLOCK REPORT COVER

Swing action clip locks documents in place, no punching required. Frosted clear cover for easy customization. Cover opens flat. 30 sheet capacity. 8½"×11".

ORDER NUMBER	DESCRIPTION	UNIT
78910-43361	Frosted	EA



E VLB® FILEMODE 11"×17" REPORT COVER

Push-n-Lock clip secures your documents. Holds up to 20 sheets.

ORDER NUMBER	DESCRIPTION	UNIT
20583-67520	Clear	EA



F CARDINAL® REPORTPRO™ 11"×17" POLY PORTFOLIO

With fasteners; 11"×17" format; holds up to 30 sheets. Acid free, transfer safe – won't lift print or damage photos.

ORDER NUMBER	DESCRIPTION	UNIT
94910	Black	EA



A OXFORD® EARTHWISE RECYCLED TWIN POCKET PORTFOLIOS

Gloss finish portfolios with a slot for a business card. Holds 100 sheets of letter size paper. Paper made with 100% recycled fibre with at least 70% post-consumer fibre. Colours: **G** Grey, **P** Green, **N** Dark Blue, **U** Burgundy, **Z** White.

ORDER NUMBER	DESCRIPTION	UNIT
PPF-DB_/B	Specify colour	25/BX



C OXFORD® EARTHWISE™ RECYCLED TWIN POCKET PORTFOLIOS

Letter size. Die-cut business card holder on inside pocket. Holds 100 sheets of paper. (50 per pocket). Contains 100% post-consumer recycled fibre.

ORDER NUMBER	DESCRIPTION	UNIT
00574	Natural	10/PK



E PENDAFLEX® PREMIUM 3-POCKET FOLDERS

Big projects in a slim folder. Unique foldover pocket design creates a more rip-resistant construction. Additional pocket on back for large scale drawings and other 11"×17" documents. Holds up to 25 pages in each inside pocket, 10 pages in outside pocket. Polypropylene. 12"×9¾"

ORDER NUMBER	DESCRIPTION	UNIT
1 77627	Olympic Blue and Charcoal	EA
2 88610	Assorted colours	12/PK



B OXFORD® TWIN POCKET PORTFOLIOS

Letter size folder with pockets inside front and back covers. Die-cut business card holder on inside pocket. Attractive leatherette embossed paper. Paper made with 10% recycled fibre with at least 10% post-consumer fibre. Acid free.

ORDER NUMBER	DESCRIPTION	UNIT
--------------	-------------	------

BOX COLOURS:

01 Light Blue, **02** Blue, **03** Green, **04** White, **05** Grey, **06** Black, **09** Yellow, **10** Orange, **11** Red, **38** Dark Blue.

1 575_ Specify colour 25/BX

6-PACK COLOURS:

01 Light Blue, **03** Green, **04** White, **06** Black, **09** Yellow, **10** Orange, **11** Red, **20** Blue, **38** Dark Blue, **55** Grey.

2 565_ Specify colour 6/PK



D OXFORD® TRI-FOLD POCKET FOLDERS

Three-panel pocket folder design allows users to deliver custom presentations or manage multiple project components with ease. Folds up to standard size for easy transport. Total capacity of 150 sheets, letter size paper (50 per pocket).

ORDER NUMBER	DESCRIPTION	UNIT
59802	Blue	EA



F OXFORD® SHOWFOLIO™ PORTFOLIOS

Glossy laminated covers bring attention to contents held in double pockets. Wing style pockets are roomy and easy to access. Reinforced sides and top resist tearing. Die cut position to display business cards on left pocket. Designed to hold up to 100 8½"×11" sheets. Colours: **01** Blue, **04** White, **06** Black, **11** Red, **17** Green, **43** Navy.

ORDER NUMBER	DESCRIPTION	UNIT
517_	Specify colour	EA



A OXFORD® TWO POCKET POLY PORTFOLIO

Durable polypropylene construction makes this portfolio tear and moisture resistant. Twin pocket folder holds 100 letter size sheets. Colours: **15** Black, **16** Orange, **17** Green, **18** Red, **19** Blue, **20** Yellow, **21** Purple.

ORDER NUMBER	DESCRIPTION	UNIT
760__	Specify colour	EA



B WINNABLE® DOCUMENT SAVERS

Strong poly cover with clear front pocket. Letter size, black.

ORDER NUMBER	DESCRIPTION	UNIT
1 LM-10-BK	10 pocket	EA
2 LM-20-BK	20 pocket	EA
3 LM-40-BK	40 pocket	EA



C WINNABLE® TWIN POCKET POLY PORTFOLIO

Interior pocket features a business card slot. Holds up to 80 sheets; 7.5 mil poly, 11"×9".

ORDER NUMBER	DESCRIPTION	UNIT
5TSE-310L-CR	Clear	5/PK



D WINNABLE® LEGAL SIZE POLY TWIN POCKET PORTFOLIO

Features business card holder; 16 mil poly. 14½"×8¾".

ORDER NUMBER	DESCRIPTION	UNIT
RP-19L-BK	Black, legal size	EA

E VLB® FILEMODE PROTECTIVE FILE POCKETS

Opens on two sides, keeping presentations and letters tidy. Thumb notch allows easy access. Colours: **1** Blue, **2** Red, **3** Clear, **5** Green, **6** Yellow.

ORDER NUMBER	DESCRIPTION	UNIT
1 20583-6027__	11"×8½, specify colour	10/PK
2 20583-60173	14"×8½, Clear	10/PK



Our Brand, YOUR Savings!



A OP BRAND PAGE PROTECTORS

Strong and durable polypropylene. Top loading. Acid free and archival safe. 2mil. Letter size.

ORDER NUMBER	UNIT
1 27811-20024	10/PK
2 27811-20023	100/BX



B OXFORD® HEAVYWEIGHT CLEAR PAGE PROTECTORS

Heavyweight 3 mils thick to survive rough daily wear. Non-stick and archival safe polypropylene endures your work routine and won't transfer ink and colours from your pages. Top loading so they're easy to insert.

ORDER NUMBER	DESCRIPTION	UNIT
1 33233	Letter size, 3 hole	100/BX
2 33234	Legal size, 3 hole	10/PK
3 33262	Legal size, 7 hole	50/PK
4 33263	11"×17", 7 hole	10/PK

C OXFORD® HEAVYWEIGHT NON-GLARE PAGE PROTECTORS

Heavyweight 3 mils thick to survive rough daily wear. A subtly textured matte finish cuts the glare without sacrificing clarity, making contents easy to read. Non-stick and archival safe polypropylene endures your work routine and won't transfer ink and colours from pages. Top loading so they're easy to insert. 3 Hole punched.



ORDER NUMBER	DESCRIPTION	UNIT
1 33242	Letter size	100/BX
2 33245	Legal size	10/PK

D OXFORD® LIGHTWEIGHT CLEAR PAGE PROTECTORS

Lightweight 2 mils thick for sheer, feather-light protection durable enough for daily tasks. Non-stick and archival safe polypropylene won't transfer ink and colours from your pages. Top loading so they're easy to insert. Reinforced 3 hole punched for durability.



ORDER NUMBER	DESCRIPTION	UNIT
33265	Letter size	100/BX

E OXFORD® LIGHTWEIGHT NON-GLARE PAGE PROTECTORS

Lightweight 2 mils thick for sheer, feather-light protection durable enough for daily tasks. Non-stick and archival safe polypropylene won't transfer ink and colours from your pages. Top loading so they're easy to insert. Reinforced 3 hole punched for durability.

ORDER NUMBER	DESCRIPTION	UNIT
1 33264	Letter size	10/PK
2 33240	Letter size	50/BX
3 33241	Letter size	100/BX



F OXFORD® SUPER HEAVYWEIGHT NON-GLARE PAGE PROTECTORS

Super Heavyweight 4 mils thick for the ultimate in long-term storage. A subtly textured matte finish cuts the glare without sacrificing clarity making contents easy to read. Made of non-stick and archival safe polypropylene for unflinching protection that won't transfer inks or colour from your pages. Top loading and 3 hole punched for convenience with a durable reinforced margin.



ORDER NUMBER	DESCRIPTION	UNIT
1 33231	Letter size	10/PK
2 33243	Letter size	100/BX

G OXFORD® SUPER HEAVYWEIGHT CLEAR PAGE PROTECTORS

Super Heavyweight 4 mils thick for the ultimate in long-term storage. Made of non-stick and archival safe polypropylene for unflinching protection that won't transfer inks or colour from your pages. Top loading and 3 hole punched for convenience with a durable reinforced margin.



ORDER NUMBER	DESCRIPTION	UNIT
1 33261	Letter size, no side margin	50/BX
2 33232	Letter size	100/BX

Oxford FEATURE

✓ FOUR-EDGED PROTECTION
keeps your papers from falling out!



A OXFORD® CLOSED TOP CLEAR PAGE PROTECTORS

These closed top page protectors have a convenient tuck-in flap to hold papers in place. Keeps projects covered, top, bottom and sides. Made of crystal clear non-stick, archival safe polypropylene. 3 Hole punched.

ORDER NUMBER	DESCRIPTION	UNIT
33239	Letter size	25/PK

B OXFORD® RECYCLED NON-GLARE PAGE PROTECTORS

Feature 60% post-consumer content. A subtly textured matte finish cuts the glare without sacrificing clarity making contents easy to read. 3 Hole punched.



ORDER NUMBER	DESCRIPTION	UNIT
33244	Letter size	100/BX

C OXFORD® CLEAR EXPANDING PAGE PROTECTORS

Expands 1" to hold multiple pages with a custom-like fit. A crystal clear finish and expandable sides will display your magazines, catalogues or presentations to their best effect. Made of heavy-duty rip-resistant vinyl. Three hole punched with a reinforced margin. Top loading for quick-and-easy inserts.



ORDER NUMBER	DESCRIPTION	UNIT
33238	Letter size	5/PK

D OXFORD® NON-GLARE SHEET PROTECTORS

Side load sheet protectors open and load on the ring side so sheets don't fall out. No matter which way you carry your binder your pages are always secure. A subtly textured matte finish cuts the glare without sacrificing clarity making contents easy to read. Made of heavy-duty 4 mils thick vinyl. 3 Hole punched.



ORDER NUMBER	DESCRIPTION	UNIT
33249	Letter size	50/BX

E OXFORD® CLEAR SHEET PROTECTORS

Side load sheet protectors open and load on the ring side so sheets don't fall out. No matter which way you carry your binder, your pages are always secure. Made of non-stick, archival safe 2.4 mil polypropylene that won't lift ink or fade colours from your pages. 3 Hole punched.



ORDER NUMBER	DESCRIPTION	UNIT
33247	Letter size	50/BX

F OXFORD® EXTRA LARGE CAPACITY NON-GLARE SHEET PROTECTORS

Store up to 50 pages to maximize your storage. A subtly textured matte finish cuts the glare without sacrificing clarity making contents easy to read. Made of non-stick, archival safe polypropylene. 3 Hole punched.



ORDER NUMBER	DESCRIPTION	UNIT
33237	Letter size	50/BX

G OXFORD® MINI SIZED PAGE PROTECTORS

Non-stick and archival safe polypropylene endures your work routine and won't transfer ink and colours from your pages. Top loading so they're easy to insert. 7 Hole punched.



ORDER NUMBER	DESCRIPTION	UNIT
33236	8½"×5½"	15/PK

Binders and Covers – clipboards and sheet holders



A GEMEX® VINYL POCKETS

Resists rips and tears. Closed on three sides, with handy thumb notch for quick and easy removal of documents. Clear vinyl, 6 mil.



ORDER NUMBER	DESCRIPTION	UNIT
1 235-10	2¼"×3½"	10/PK
2 46-10	4"×6"	10/PK
3 8511-10	8½"×11"	10/PK
4 912-10	9"×12"	10/PK



NEW!

C MERANGUE PADFOLIO

Ribbed textured PVC free material. Snap closure and inside pocket. 9¼"×12½".

ORDER NUMBER	DESCRIPTION	UNIT
1 1020-2100-00-000	Green	EA
2 1020-2110-00-000	Blush	EA
3 1020-2120-00-000	Blue	EA



E WESTCOTT® ANTIMICROBIAL PLASTIC CLIPBOARD

Plastic parts contain an antimicrobial agent to help inhibit growth of bacterial stains and odours. Heavy duty spring clip and hang-up hole for easy storage. Blue.

ORDER NUMBER	DESCRIPTION	UNIT
65956-37920	Letter size	EA



F MERANGUE PLASTIC CLIPBOARD

Rust resistant, nickel-plated, spring action metal clip with convenient hanging hole. Clear.

ORDER NUMBER	DESCRIPTION	UNIT
1020-1591-00-000	6"×9"	EA



B DAVIS GROUP™ QUICKFIT® SHOP TICKET HOLDER

Protect work orders, production schedules, important documents and more. Durable design with double stitched edging. Clear on both sides. Convenient grommet hole for hanging and displaying materials. Top loading. Polypropylene. 9"×12". Black.



ORDER NUMBER	UNIT
1 41300	EA
2 41305	5/PK



D WESTCOTT® ALUMINUM SHEET HOLDERS

ORDER NUMBER	DESCRIPTION	UNIT
1 65956-38212	Letter size, top hinged, outer clip	EA
2 65956-38012	Letter size, side hinged	EA
3 65956-38015	Legal size, side hinged	EA
4 65956-38112	Letter size, bottom hinged	EA



G WINNABLE® POLY CLIPBOARD

Letter size. Grey.

ORDER NUMBER	UNIT
30100	EA

Binders and Covers – clipboards and sheet holders



A WESTCOTT® KLEENEARTH® MASONITE CLIPBOARDS

Smooth on both sides. Made with 70% recycled and 30% post-consumer content.

ORDER NUMBER	DESCRIPTION	UNIT
1 65956-35069	6"×9"	EA
2 65956-35912	9"×12"	EA
3 65956-35915	9"×15"	EA



B WESTCOTT® PLASTIC CLIPBOARDS

6" Wide, strong spring clip. 9"×12".

ORDER NUMBER	DESCRIPTION	UNIT
1 65956-37912	Clear plastic	EA
2 65956-37911	Smoke	EA



C VLB DURAPLY® STAY CLEAN CLIPBOARDS

Polypropylene. Black.

ORDER NUMBER	DESCRIPTION	UNIT
1 20583-98981	8½"×11"	EA
2 20583-98982	8½"×14"	EA
3 20583-98984	11"×17"	EA

FOLDING WITH INSIDE POCKET
Double clip for portrait and landscape format.

4 20583-69845	11"×17"	EA
---------------	---------	----



D DAVIS GROUP ESSENTIAL CLIPBOARD PORTFOLIO

Lever-type clip. Features two inside memo pockets. 12½"×9½". Polypropylene.

ORDER NUMBER	DESCRIPTION	UNIT
1 4511-01	Black	EA
2 4511-72	Navy	EA



E WESTCOTT® ALUMINUM CLIPBOARD

ORDER NUMBER	DESCRIPTION	UNIT
1 65956-38120	Letter size	EA
2 65956-38125	Legal size	EA



F WESTCOTT® KLEENEARTH® ARCH FILE CLIPBOARDS

Made with 70% recycled and 30% post-consumer content.

ORDER NUMBER	DESCRIPTION	UNIT
1 65956-35812	Letter size	EA
2 65956-35815	Legal size	EA



G STOREX® POLY CLIPBOARD

Features a built-in pen holder. Pearlized blue poly; letter size.

ORDER NUMBER	DESCRIPTION	UNIT
41101U12C	9"×12"	EA



H DAVIS GROUP™ CLIP-STYLE PORTFOLIO

Front cover lies flat when closed. With alligator clip and inside pocket. Vinyl.

ORDER NUMBER	DESCRIPTION	UNIT
35471	8½"×11"	EA



Reversaflex®

A tidy drawer is our
happy place.



Documents stay neatly organized and easy to find in **Reversaflex® Hanging Folders**. Plus, they are poly-reinforced along the top and bottom edges for added durability.



A PENDAFLEX® REVERSAFLEX® HANGING FOLDERS

Poly-laminate reinforced. Hard and soft tab compatible Coated rods for smoother gliding. Lighter shaded interior helps prevent misfiling. Paper made with 10% recycled fibre with at least 10% post-consumer fibre. Colours: **BLK** Black, **BLU** Blue, **BUR** Burgundy, **GRN** Green, **GRY** Grey, **NAV** Navy Blue, **ORG** Orange, **PNK** Pink, **RED** Red, **TEA** Teal, **VIO** Violet, **YLW** Yellow.

ORDER NUMBER	DESCRIPTION	UNIT
1 05152-___	Letter, specify colour	25/BX
2 05152	Letter, Standard Green	25/BX
3 05153-___	Legal, specify colour	25/BX
4 05153	Legal, Standard Green	25/BX



C CONTINENTAL COLOURED HANGING FOLDERS

Reinforced steel rods with coated tips allow folders with a heavy load to still slide easily. 11 pt. stock. Assorted colours: red, yellow and blue.



ORDER NUMBER	DESCRIPTION	UNIT
--------------	-------------	------

CONTAINS 100% POST-CONSUMER RECYCLED MATERIAL

1 25377-30225	Letter size	25/BX
2 25377-37225	Legal size	25/BX

CONTAINS A MINIMUM OF 60% POST-CONSUMER MATERIAL

NEW! 3 25377-30915	Letter size	10/PK
NEW! 4 25377-37915	Legal size	10/PK



D PENDAFLEX® GLOW HANGING FOLDERS

Helps files stand out. 11 pt. paper stock. Contains a minimum of 10% post-consumer recycled content. Letter size. Assorted neon colours.

ORDER NUMBER	DESCRIPTION	UNIT
81670	Letter size	12/PK



B OP® BRAND HANGING FOLDERS

Accepts standard flexible tabs. Contains 100% post-consumer recycled material. Durable 11 pt. stock. Acid free.

ORDER NUMBER	DESCRIPTION	UNIT
--------------	-------------	------

LETTER SIZE

1 27811-30012	Standard Green	25/BX
2 27811-30500	Standard Green	50/BX
3 27811-30502	Natural	50/BX
4 27811-30510	Yellow	25/BX
5 27811-30511	Red	25/BX
6 27811-30512	Blue	25/BX
7 27811-30513	Violet	25/BX
8 27811-30514	Light Green	25/BX
9 27811-30515	Black	25/BX
10 27811-30516	Grey	25/BX

LEGAL SIZE

11 27811-30013	Standard Green	25/BX
12 27811-30501	Standard Green	50/BX
13 27811-30504	Natural	50/BX
14 27811-30517	Yellow	25/BX
15 27811-30518	Red	25/BX
16 27811-30519	Blue	25/BX
17 27811-30520	Violet	25/BX
18 27811-30521	Light Green	25/BX
19 27811-30522	Black	25/BX
20 27811-30523	Grey	25/BX

Our Brand, YOUR Savings !



E PENDAFLEX® READY-TAB™ HANGING FOLDERS WITH LIFT TAB™ TECHNOLOGY

Innovative built-in tabs lift up easily, are angled for easy readability, are always available and can't fall out. Simply lift tab, snap into place and label. Includes permanent self-adhesive labels, or simply write directly on the tab. Paper made with 10% recycled fibre with at least 10% post-consumer fibre. Colour assortment: yellow, red, green, orange and blue.

ORDER NUMBER	DESCRIPTION	UNIT
--------------	-------------	------

1 42590	Letter, standard green	25/BX
2 42592	Letter, assorted colours	25/BX
3 42591	Legal, standard green	25/BX
4 42593	Legal, assorted colours	25/BX



A PENDAFLEX® SUREHOOK™ HANGING FILE FOLDERS

Features revolutionary built-in tension springs. Reinforced poly laminated rods and hooks are stronger and sturdier, bending less and allowing folders to slide more easily. Lighter colour interior. Paper made with 10% recycled fibre with at least 10% post-consumer fibre.

ORDER NUMBER	DESCRIPTION	UNIT
1 6152C	Letter, standard green	20/BX
2 6152CAS	Letter, assorted colours	20/BX
3 6153C	Legal, standard green	20/BX
4 6153CAS	Legal, assorted colours	20/BX



B PENDAFLEX® SUREHOOK™ HANGING BOX FILES

Features revolutionary built-in tension springs; rods and hooks are stronger and sturdier, bend less and allow folders to slide more easily. Letter and legal size for large capacity files. Tear-resistant closed sides keep papers from slipping out. Poly-laminate reinforced for ten times greater durability. Paper made with 10% recycled fibre with at least 10% post-consumer fibre. Packaged with flexible tabs. Acid free. Blue.

ORDER NUMBER	DESCRIPTION	UNIT
1 59203	3" Letter	25/BX
2 59303	3" Legal	25/BX

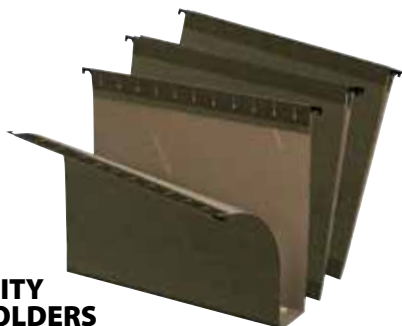

C PENDAFLEX® SUREHOOK™ 2" EXTRA CAPACITY HANGING FILE FOLDERS

Features revolutionary built-in tension springs. Reinforced poly laminated rods and hooks are stronger and sturdier, bending less and allowing folders to slide more easily. Sturdy box bottom for filing bulky items such as journals, reports or catalogues. Lighter colour interior. Acid-free. Paper made with 10% recycled fibre with at least 10% post-consumer fibre.

ORDER NUMBER	DESCRIPTION	UNIT
1 6152X2C	Letter, standard green	20/BX
2 6153X2C	Legal, standard green	20/BX



D CONTINENTAL EXTRA CAPACITY HANGING FOLDERS

Built-in pressboard box bottom designed to hold larger amounts of documents. Reinforced steel rods with coated tips. Contains 100% post-consumer recycled material. 11 pt. stock. Acid free. Standard Green. Box of 25.

ORDER NUMBER	DESCRIPTION	UNIT
1 25377-30282	2" Letter size	25/BX
2 25377-37282	2" Legal size	25/BX
3 25377-37292	3" Legal size	25/BX



E PENDAFLEX® SUREHOOK™ REINFORCED EXTRA CAPACITY HANGING POCKETS

SureHook™ technology with longer plastic hooks and built-in tension springs. Slotted front and back panels to accept tabs (not included); 3 3/4" expansion. Paper made with 10% recycled fibre with at least 10% post-consumer fibre. Standard green.

ORDER NUMBER	DESCRIPTION	UNIT
1 09217	Letter, 12 3/4" x 9 1/4"	4/PK
2 09317	Legal, 15 3/4" x 9 1/4"	4/PK



F PENDAFLEX® READY-TAB™ EXTRA CAPACITY HANGING FOLDERS WITH LIFT TAB™

Built-in tabs are pre-attached and lift up easily into place. Pressboard reinforced, 2" expanding bottom. Contains a minimum of 10% post-consumer recycled material. Includes permanent labels.

ORDER NUMBER	DESCRIPTION	UNIT
1 42700	Letter, assorted colours	20/BX
2 42702	Legal, assorted colours	20/BX



Filing – hanging folder frames and tabs



A OP® BRAND FLEXIBLE TABS
Complete with blank inserts.

ORDER NUMBER	DESCRIPTION	UNIT
1 27811-30650	2", Assorted colours	25/PK
2 27811-30651	2", Clear	25/PK
3 27811-30652	3½", Assorted colours	25/PK
4 27811-30653	3½", Clear	25/PK

Our Brand, YOUR Savings !

B PENDAFLEX® REVERSAFLEX® FLEXIBLE FILE TABS
Clear tabs for hanging folders. Complete with blank inserts.

ORDER NUMBER	DESCRIPTION	UNIT
1 42	2" tab	25/PK
2 43-1/2-TOP	3½" tab	25/PK



C PENDAFLEX® REVERSAFLEX® HANGING FOLDER FRAME
Adjustable to accommodate letter or legal size hanging file folders. Easy to assemble. Made of premium grade rust-proof steel with coated rods.

ORDER NUMBER	DESCRIPTION	UNIT
450	Letter/Legal	EA



D PENDAFLEX® REVERSAFLEX® MOULDED TABS
Easy to use tabs lock into position and allow for top-loading of inserts. Clear, hard molded plastic tabs in 2" or 3½" widths. Blank and printed inserts included.

ORDER NUMBER	DESCRIPTION	UNIT
1 32-CLR	2"	25/BX
2 33-1/2-CLR	3½"	25/BX



E PENDAFLEX® HANGING FOLDER FRAME
Fits both letter and legal size folders. Adjusts from 18" to 27". Heavy-duty steel wire and corner post construction. Easy to assemble.

ORDER NUMBER	DESCRIPTION	UNIT
D602	Letter/Legal	EA



F FELLOWES® DESKTOPPER™ FILE ORGANIZERS
Keep current files organized and ready at hand on your desktop. Plastic support rack includes hanging file folders. Made from 100% recycled material.

ORDER NUMBER	DESCRIPTION	UNIT
1 77511-00534	Letter, Black	EA
2 77511-00544	Legal, Black	EA



G PENDAFLEX® HANGING FOLDER FRAME
Create an all-in-one organization system you can place right on your desk or wherever you work. Non-skid feet keep this hanging file folder frame in place. Lightweight and easy to assemble.

ORDER NUMBER	DESCRIPTION	UNIT
44126	Letter, 12½" W×16" D×9¾" H	EA



H WINNABLE® DESKTOP HANGING FILES
Organizes desktop files and folders. Black mesh complements desk accessories, trays and organizers.

ORDER NUMBER	DESCRIPTION	UNIT
1 14522	Letter, 9⅝"×5¼"×12½"	EA
2 14523	Legal, 9⅝"×5¼"×15¼"	EA

G PENDAFLEX® HANGING FOLDER FRAME
Create an all-in-one organization system you can place right on your desk or wherever you work. Non-skid feet keep this hanging file folder frame in place. Lightweight and easy to assemble.

ORDER NUMBER	DESCRIPTION	UNIT
44126	Letter, 12½" W×16" D×9¾" H	EA

Check online for the most current price.

Filing – file folders



A PENDAFLEX® REVERSIBLE TAB FILE FOLDERS

Manila and Ivory: paper made with 10% recycled fibre with at least 10% post-consumer fibre. Natural Sand: paper made with 100% recycled fibre with at least 60% post-consumer fibre.

ORDER NUMBER	DESCRIPTION	UNIT
LETTER SIZE		
1 R409	Manila 9.5pt.	100/BX
2 R411	Ivory 9.5pt.	100/BX
3 R412	Natural Sand 10.5pt.	100/BX
4 R413	Ivory 10.5pt.	100/BX
LEGAL SIZE		
5 R609	Manila 9.5pt.	100/BX
6 R611	Ivory 9.5pt.	100/BX
7 R612	Natural Sand 10.5pt.	100/BX
8 R613	Ivory 10.5pt.	100/BX

NEW!

C CONTINENTAL REVERSIBLE FILE FOLDERS

Designed with a two-sided tab allowing for double-line filing. Contains 100% post-consumer recycled material. ½ cut tab. 10½ pt. Manila.



ORDER NUMBER	DESCRIPTION	UNIT
1 25377-41910	Letter size	10/PK
2 25377-46910	Legal size	10/PK



E PENDAFLEX® REVERSIBLE TAB COLOURED FILE FOLDERS

Paper made with 10% recycled fibre with at least 10% post-consumer fibre. ½ cut tabs. 10 ½ pt.

Colours: **BLK** Black, **BLU** Blue, **BUR** Burgundy, **GRN** Green, **GRY** Grey, **NAV** Navy, **ORG** Orange, **PNK** Pink, **RED** Red, **TEA** Teal, **VIO** Violet, **YLW** Yellow.

ORDER NUMBER	DESCRIPTION	UNIT
1 R415-__	Letter size, specify colour	100/BX
2 R615-__	Legal size, specify colour	100/BX
3 R415-25 AST	Letter size, assorted colours	25/PK
4 R615-25 AST	Legal size, assorted colours	25/PK

Our Brand, YOUR Savings!



B OP BRAND REVERSIBLE FILE FOLDERS

Manila contains 100% post-consumer recycled material, while Kraft and Ivory contain 10%. ½ cut tab. 10 ½ pt.



ORDER NUMBER	DESCRIPTION	UNIT
LETTER SIZE		
1 27811-30010	Manila	100/BX
2 27811-30100	Kraft	100/BX
3 27811-30101	Ivory	100/BX
LEGAL SIZE		
4 27811-30011	Manila	100/BX
5 27811-30102	Kraft	100/BX
6 27811-30103	Ivory	100/BX



D OP BRAND COLOURED REVERSIBLE FILE FOLDERS

Contains 10% post-consumer recycled material. ½ cut tab. 10½ pt. stock.



ORDER NUMBER	DESCRIPTION	UNIT
LETTER SIZE		
1 27811-30121	Burgundy	100/BX
2 27811-30122	Yellow	100/BX
3 27811-30123	Teal	100/BX
4 27811-30124	Red	100/BX
5 27811-30125	Dark Blue	100/BX
6 27811-30126	Orange	100/BX
7 27811-30127	Violet	100/BX
8 27811-30128	Pink	100/BX
9 27811-30129	Green	100/BX
10 27811-30130	Black	100/BX
11 27811-30131	Blue	100/BX
12 27811-30132	Grey	100/BX
LEGAL SIZE		
13 27811-30133	Burgundy	100/BX
14 27811-30134	Yellow	100/BX
15 27811-30135	Teal	100/BX
16 27811-30136	Red	100/BX
17 27811-30137	Dark Blue	100/BX
18 27811-30138	Orange	100/BX
19 27811-30139	Violet	100/BX
20 27811-30140	Pink	100/BX
21 27811-30141	Green	100/BX
22 27811-30142	Black	100/BX
23 27811-30143	Blue	100/BX
24 27811-30144	Grey	100/BX



A PENDAFLEX® DOUBLE TOP-REINFORCED TAB FOLDERS

Folders have double the thickness across the tab and top edge where strength is needed. Contains a minimum of 10% post-consumer recycled material. ½ cut tab. 9½ pt. Ivory.

ORDER NUMBER	DESCRIPTION	UNIT
1 IDT411 RT	Letter	100/BX
2 IDT611 RT	Legal	100/BX



C HILROY® ENVIRO PLUS™ RECYCLED FILE FOLDERS

Made from 100% recycled, 60% post-consumer content. Printed using non-toxic water-based inks. Assorted packs contain 10 each of Red, Green, Blue and Yellow. Boxes of 100 are solid colour Sand.

ORDER NUMBER	DESCRIPTION	UNIT
1 65800-55070	Letter, assorted colours	40/PK
2 65800-65000	Legal, assorted colours	40/PK
3 65800-55074	Letter, Sand	100/BX
4 65800-65002	Legal, Sand	100/BX

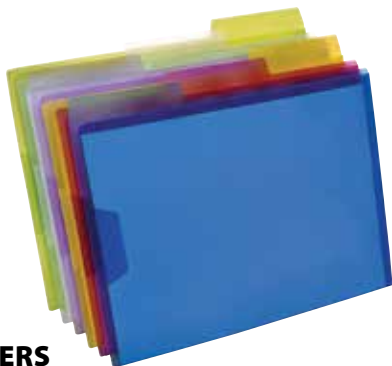

E PENDAFLEX® POLY VIEW FOLDERS

Translucent folders allow you to see contents at a glance. Flap secures papers inside. Polypropylene is wear, tear and moisture resistant. Six assorted colours per package.

ORDER NUMBER	DESCRIPTION	UNIT
52565	Letter size	6/PK

Pendaflex® FEATURE



B PENDAFLEX® GLOW FILE FOLDERS

A brilliant way to colour-code files for better than boring organization. Contains a minimum of 10% post-consumer recycled material. ½ cut tab. Letter size. Assorted neon colours.

ORDER NUMBER	DESCRIPTION	UNIT
1 57100	Letter, Glow	24/PK
2 67100	Letter, Twisted Glow	24/PK



D PENDAFLEX® CUTLESS® WATERSHED® REVERSIBLE FILE FOLDERS

WaterShed®/CutLess® paper makes these folders resistant to spills and helps to reduce the risk of paper cuts. Contains a minimum of 30% post-consumer recycled material. ½ cut tab. 12 pt. Manila.

ORDER NUMBER	DESCRIPTION	UNIT
1 48430C	Letter	100/BX
2 48431C	Legal	100/BX



F PENDAFLEX® DOUBLE STUFF® FILE FOLDERS

Double Stuff® File folders pack twice the capacity of standard folders. Contains a minimum of 10% post-consumer recycled material. ½ cut tabs in assorted positions. Spines expand to 1½" to hold over 400 sheets. Manila.

ORDER NUMBER	DESCRIPTION	UNIT
77000	Letter	24/PK

Filing – end tab (shelf)

A PENDAFLEX® SHELF FOLDERS WITH SINGLE-PLY END TAB

Paper made with 10% recycled fibre with at least 10% post-consumer fibre. Ivory 10½ pt stock. Full tab. Acid free.



ORDER NUMBER	DESCRIPTION	UNIT
1 413EF	Letter size: 9½"×12¼"	100/BX
2 613EF	Legal size: 9½"×15¼"	100/BX



C PENDAFLEX® EXTRA HEAVY RED FIBRE SHELF FILE POCKETS

Extra durability for files that are referenced on a daily basis. Scored on sides. Drop front. Paper made with 10% recycled fibre with at least 10% post-consumer fibre. SFI Certified Sourcing.

ORDER NUMBER	DESCRIPTION	UNIT
1 95343	Letter, 3½" expansion	EA
2 95545	Legal, 3½" expansion	EA
3 95565	Legal, 5¼" expansion	EA

E PENDAFLEX® SHELF FILE FOLDERS WITH REINFORCED TABS

Extra-strong reinforced tab provides superior durability for busy filing systems. Contains a minimum of 10% post-consumer recycled material. Full end-tab, two-ply.



ORDER NUMBER	DESCRIPTION	UNIT
1 97260	10½ pt., letter size	100/BX
2 98260	13½ pt., letter size	100/BX
3 97360	10½ pt., legal size	100/BX
4 98360	13½ pt., legal size	100/BX

F PENDAFLEX® SHELF FOLDERS WITH REINFORCED TAB

Double ply straight tabs. Superior durability for busy filing systems. Manila 11 pt. stock. Paper made with 10% recycled fibre with at least 10% post-consumer fibre.



ORDER NUMBER	DESCRIPTION	UNIT
1 H110D	Letter size: 9½"×12¼"	100/BX
2 H210D	Legal size: 9½"×15¼"	100/BX



B PENDAFLEX® COLOURED END TAB FILE FOLDERS

Ideal for colour-coding numerical and alphabetical systems. Reinforced tab. Paper made with 10% recycled fibre with at least 10% post-consumer fibre. Colours: **BL** Blue, **GR** Green, **OR** Orange, **P** Pink, **R** Red, **TQ** Turquoise, **Y** Yellow. Specify colour.

ORDER NUMBER	DESCRIPTION	UNIT
1 H110D_	Letter size: 9½"×12¼", 11 pt. stock	100/BX
2 H210D_	Legal size: 9½"×15¼", 13.5 pt. stock	50/BX



D PENDAFLEX® MANILA SHELF FOLDERS WITH FASTENERS

Reinforced double tabs; 2" capacity fasteners. Fastener positions #1 and #3; 11 pt. stock. Paper made with 10% recycled fibre with at least 10% post-consumer fibre.

ORDER NUMBER	DESCRIPTION	UNIT
1 H10U13	Letter	50/BX
2 H20U13	Legal	50/BX



G PENDAFLEX® PRESSBOARD FOLDERS

Heavy weight, rigid stock provides exceptional durability. Reinforced tape gusset bottom for 1" expansion. Contains a minimum of 30% post-consumer recycled material. Straight cut. 25 pt. Green.



ORDER NUMBER	DESCRIPTION	UNIT
1 P421 S5	Letter size	5/PK
2 P621 S5	Legal size	5/PK



A PENDAFLEX® DIVIDE IT UP™ FILE FOLDERS

One folder with three interior staggered pockets for subdividing projects or managing large documents. Half-cut label tabs, smaller tabs on interior pockets. Sealed on two sides; total capacity 175 sheets. Available in manila and assorted pack. Acid free. Paper made with 10% recycled fibre with at least 10% post-consumer fibre. Letter size.

ORDER NUMBER	DESCRIPTION	UNIT
1 10770	Manila, 9½ pt	24/PK
2 10772	Assorted colours, 11pt	24/PK

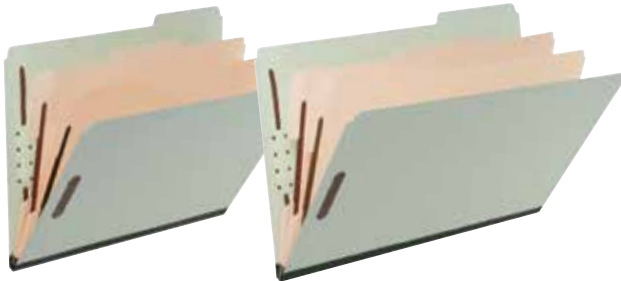

C PENDAFLEX® CLASSIFICATION FOLDERS

Durable 25 pt. green pressboard folder with two built-in ivory dividers. Equipped with six fasteners. Three inch expandable reinforced tape gusset. Acid free. Covers made with 60% recycled fibre with at least 30% post-consumer fibre; dividers made with 10% recycled fibre with at least 10% post-consumer fibre.

ORDER NUMBER	DESCRIPTION	UNIT
1 36488	Letter size (P43-6)	3/PK
2 P43-6	Letter size	10/BX
3 36489	Legal size (P63-6)	3/PK
4 P63-6	Legal size	10/BX



E PENDAFLEX® SLIMTRIM® FASTENER FOLDERS

Fastener has a 2" capacity and holds paper securely in folder. Fastener position #1; ½ cut right tab. Paper made with 10% recycled fibre with at least 10% post-consumer fibre.

ORDER NUMBER	DESCRIPTION	UNIT
1 STR413RT-10-10	Letter size	10/PK
2 STR613RT-10-10	Legal size	10/PK



B PENDAFLEX® LAMINATED FOLDERS WITH FASTENERS

Poly laminate reinforced bottom score. 2" capacity fasteners. Contains a minimum 10% post-consumer recycled material. Straight cut, reinforced tabs. 11 pt. Manila.

ORDER NUMBER	DESCRIPTION	UNIT
FASTENER POSITION #1		
1 13140	Letter size	50/BX
2 13210	Legal size	50/BX
FASTENER POSITION #1 AND 3		
3 13160	Letter size	50/BX
4 13220	Legal size	50/BX



D PENDAFLEX® COLOURED CLASSIFICATION FOLDERS

Inner divider helps subdivide your documents within the folders. Includes 2 dividers and 6 total fasteners. Made with 25 pt. Pressboard covers and 17 pt. Kraft dividers. Covers made from 60% recycled fiber with 30% post-consumer fibre. Dividers made from 10% post-consumer fibre.

ORDER NUMBER	DESCRIPTION	UNIT
1 24132P	Letter size, Blue	EA
2 24133P	Letter size, Green	EA
3 24131P	Letter size, Red	EA
4 29035P	Legal size, Blue	EA
5 29033P	Legal size, Green	EA
6 29031P	Legal size, Red	EA



F PENDAFLEX® PRESSBOARD SHELF CLASSIFICATION FOLDERS

Six built-in fasteners. Contains a minimum of 30% post-consumer recycled material. Straight cut cover tab, ⅓ cut interior dividers. 2" expandable reinforced tape gusset. 25 pt. thickness on outer shell and 17 pt. on interior dividers. Pale Green.

ORDER NUMBER	DESCRIPTION	UNIT
1 23224	Letter size	EA
2 23324	Legal size	EA

A PENDAFLEX® DATAFILE® COMPATIBLE ALPHABETIC SHELF FILING LABELS STARTER KIT

Includes 3840 A-Z labels, 1¼" W×1⅝" H, A-Z file guides and file box.



ORDER NUMBER	UNIT
06600	PK

C PENDAFLEX® DATAFILE® COMPATIBLE ALPHABETIC SHELF FILING LABELS

A-Z labels, 1¼" W×1⅝" H.



ORDER NUMBER	DESCRIPTION	UNIT
1	06601 Letter A, Pink	240/PK
2	06602 Letter B, Red	240/PK
3	06603 Letter C, Light orange	240/PK
4	06604 Letter D, Dark orange	240/PK
5	06605 Letter E, Yellow	240/PK
6	06606 Letter F, Light green	240/PK
7	06607 Letter G, Dark green	240/PK
8	06608 Letter H, Light blue	240/PK
9	06609 Letter I, Purple	240/PK
10	06610 Letter J, Lilac	240/PK
11	06611 Letter K, Brown	240/PK
12	06612 Letter L, Light brown	240/PK
13	06613 Letter M, Pink	240/PK
14	06614 Letter Mc, Pink	240/PK
15	06615 Letter N, Red	240/PK
16	06616 Letter O, Light orange	240/PK
17	06617 Letter P, Dark orange	240/PK
18	06618 Letter Q, Yellow	240/PK
19	06619 Letter R, Light green	240/PK
20	06620 Letter S, Dark green	240/PK
21	06621 Letter T, Light blue	240/PK
22	06622 Letter U, Purple	240/PK
23	06623 Letter V, Lilac	240/PK
24	06624 Letter W, Brown	240/PK
25	06625 Letter X, Light brown	240/PK
26	06626 Letter Y, White-grey	240/PK
27	06627 Letter Z, Grey-white	240/PK

E PENDAFLEX® DATAFILE® COMPATIBLE YEAR SHELF FILING LABELS

1¼" W×1⅝" H.



ORDER NUMBER	DESCRIPTION	UNIT
1	06722 2022, Light Orange	500/BX
2	06723 2023, Orange	500/BX
3	NEW! 06724 2024, Light Green	500/BX

B PENDAFLEX® DATAFILE® COMPATIBLE NUMERIC SHELF FILING LABELS STARTER KIT

Includes 500 labels each of 0-9 (1¼" W×1⅝" H).



ORDER NUMBER	UNIT
06640	PK



D PENDAFLEX® DATAFILE® COMPATIBLE NUMERIC SHELF FILING LABELS

Numeric labels in rolls.

ORDER NUMBER	DESCRIPTION	UNIT
1	06630 Number 0, Pink	500/BX
2	06631 Number 1, Red	500/BX
3	06632 Number 2, Light orange	500/BX
4	06633 Number 3, Dark orange	500/BX
5	06634 Number 4, Light green	500/BX
6	06635 Number 5, Dark green	500/BX
7	06636 Number 6, Blue	500/BX
8	06637 Number 7, Purple	500/BX
9	06638 Number 8, Lilac	500/BX
10	06639 Number 9, Brown	500/BX

E POST-IT® FILING TABS

Easy to write on and reposition. Assorted colours.



ORDER NUMBER	DESCRIPTION	UNIT
FLAT FILING TAB		
1	686F-1 2"×1½"	24/PK
ANGLED HANGING FOLDER TAB		
2	686A-1B 2"×1½"	24/PK

F PENDAFLEX® A-Z FILE GUIDES

Legal or letter size; 25-pt green pressboard. Paper made with 65% recycled fibre with at least 30% post-consumer fibre



ORDER NUMBER	DESCRIPTION	UNIT
1	P425U Letter size	ST
2	P625U Legal size	ST

**A AVERY®
REMOVABLE FILE
FOLDER LABELS**

Labels stick, stay and remove cleanly to make changes and revisions. Adheres to smooth surfaces including paper, cardboard, plastic, wood, glass and metal. Label size: 3 7/16" x 2 2/3". Laser and ink jet compatible.



ORDER NUMBER	DESCRIPTION	UNIT
67933-06505	White	300/PK



**C AVERY®
REMOVABLE COLOUR CODING LABELS**

Round coloured labels help keep files organized.

ORDER NUMBER	DESCRIPTION	UNIT
3/4" ROUND		
1 67933-02343	Red	240/PK
2 67933-02344	Green	240/PK
3 67933-02345	Blue	240/PK
4 67933-02346	Yellow	240/PK
5 67933-02348	Assorted	240/PK
1/2" ROUND		
6 67933-02397	Red	420/PK
7 67933-02398	Green	420/PK
8 67933-02399	Yellow	420/PK
1/4" ROUND		
9 67933-02395	Blue	768/PK
10 67933-02396	Yellow	768/PK
11 67933-02394	Green	768/PK
12 67933-02335	Red	768/PK
13 67933-02339	Assorted colours	768/PK



E PENDAFLEX® SORTER

With 31 flexible leaves for sorting envelopes, brochures and letters. Sorts alphabetically, numerically, monthly, by day of the month and day of the week.

ORDER NUMBER	UNIT
40652	EA



B AVERY® FILE FOLDER LABELS

Permanent bright white labels with TrueBlock™ technology, guaranteed to cover everything underneath. Laser and ink jet compatible.

ORDER NUMBER	DESCRIPTION	UNIT
3 7/16" x 2 2/3"		
1 67933-05066	Red	600/PK
2 67933-05366	White	600/PK
3 67933-05566	White	1500/BX
4 67933-05766	Blue	600/PK
5 67933-05866	Green	600/PK
6 67933-05966	Yellow	600/PK
7 67933-05266	Assorted colours	600/PK
3 7/16" x 1 5/8"		
8 67933-35027	White extra large	360/PK

**D AVERY®
FILE FOLDER
LABELS**

Permanent labels in sheets; for laser or ink jet printer or write on.



ORDER NUMBER	DESCRIPTION	UNIT
1 67933-02327	3 1/2" x 1 1/8", White	70/PK
2 67933-02326	3 1/2" x 1 1/8", Red	70/PK
3 67933-02328	3 1/2" x 1 1/8", Green	70/PK
4 67933-02325	3 1/2" x 1 1/8", Dark blue	70/PK
5 67933-02329	3 1/2" x 1 1/8", Assorted	70/PK

**F WESTCOTT®
FINGER STALLS**

Non-ventilated.



ORDER NUMBER	DESCRIPTION	UNIT
1 65956-00710	Extra small	12/BX
2 65956-00711	Small	12/BX
3 65956-00712	Medium	12/BX
4 65956-00713	Large	12/BX
5 65956-00714	Extra large	12/BX
6 65956-00715	Assorted	12/BX

Filing – expanding files



A PENDAFLEX® EXPANDING FILE JACKETS

Heavy weight file folder stock. Straight cut pocket expands to 1½" or 2" capacity. Closed on three sides to keep documents securely inside; thumb cut front for quick access. Paper made with 10% recycled fibre with at least 10% post-consumer fibre.

ORDER NUMBER	DESCRIPTION	UNIT
1" EXPANSION - SINGLE PLY TAB		
1 12100	Letter size	EA
1½" EXPANSION - SINGLE PLY TAB		
2 13125EE	Legal size	5/PK
2" EXPANSION - REINFORCED TAB		
3 22205EE	Letter size	5/PK
4 23205EE	Legal size	5/PK



C WINNABLE POLY FILE JACKETS

Durable translucent poly, moisture and tear resistant; 1" expansion. Five assorted colours: Blue, red, purple, yellow and green.

ORDER NUMBER	DESCRIPTION	UNIT
1 FJ-01-AD	Letter size	5/PK
2 FJ-02-AD	Legal size	5/PK



E PENDAFLEX® CLEAR FRONT POLY SNAP ENVELOPES

Clear front panel for easy viewing. Poly envelope with snap closure keeps contents secure. Top loading. Letter size.

ORDER NUMBER	DESCRIPTION	UNIT
95195	Assorted patterns	3/PK



B WINNABLE® POLY EXPANDING POCKETS

Strong, long-lasting poly file pockets are moisture- and stain-resistant. Clear front and gusset. 3½" expansion. Blue.

ORDER NUMBER	DESCRIPTION	UNIT
1 FP-31-DB	Letter size	EA
2 FPL-31-DB	Legal size	EA



D PENDAFLEX® FILE JACKETS

Full height sides with closed bottom. Thumb cut front for easy access. Contains a minimum of 10% post-consumer recycled material. Letter size.

ORDER NUMBER	DESCRIPTION	UNIT
49501	Assorted neon colours	10/PK



F MEAD® EXPANDING BRITE WALLETS®

Tint-a-Web construction with Velcro® closure; expandable to 2". Assorted fluorescent colours.

ORDER NUMBER	DESCRIPTION	UNIT
1 43100-35362	Letter size	EA
2 43100-35364	Legal size	EA



A PENDAFLEX® FILE POCKETS

For use with larger files. Red fibre material with rollover reinforced gussets. Paper made with 30% recycled fibre with at least 30% post-consumer fibre.

ORDER NUMBER	DESCRIPTION	UNIT
1 1514C-OX	Letter, 1¾"	EA
2 E51524E	Letter, 3½"	5/PK
3 1534G5	Letter, 5¼"	5/PK
4 1516C-OX	Legal, 1¾"	EA
5 E51526E	Legal, 3½"	5/PK
6 1536G5	Legal, 5¼"	5/PK

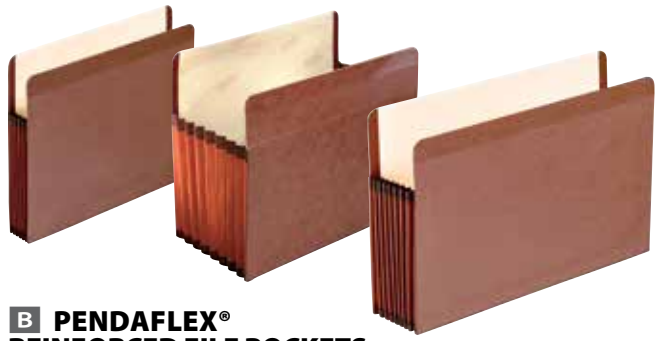

B PENDAFLEX® REINFORCED FILE POCKETS

Fully lined gussets with extra reinforcements at tops and bottoms for added strength. Reinforcement strips at critical wear points to prevent bursting or tearing. Specially coated red fibre is moisture resistant to protect against spills and dampness. Paper made with 10% recycled fibre with at least 10% post-consumer fibre.

ORDER NUMBER	DESCRIPTION	UNIT
1 085545	Letter, 5¼"	EA
2 085565	Legal, 5¼"	EA
3 45302	Letter, 7"	EA
4 45303	Legal, 7"	EA



C PENDAFLEX® FULL CABINET FILE POCKETS

Accordion style expands for maximum filing. Extra tall gusset, no interference when removing from filing cabinet. Contains a minimum of 30% post-consumer recycled material. Straight cut tab.

ORDER NUMBER	DESCRIPTION	UNIT
1 1534GFC	Letter size, 5¼" expansion	EA
2 1536GFC	Legal size, 5¼" expansion	EA



D PENDAFLEX® COLOURED FILE POCKETS

Perfect for colour coding files. Colour matched gusset is nylon reinforced. Double-thick front and back; moisture resistant coating; 3½" expansion. Paper made with 10% recycled fibre with at least 10% post-consumer fibre.

ORDER NUMBER	DESCRIPTION	UNIT
1 1524ER-OX	Letter size, Red	EA
2 1524EB-OX	Letter size, Blue	EA
3 1526ER-OX	Legal size, Red	EA
4 1526EB-OX	Legal size, Blue	EA



E WINNABLE® EXPANDING DESKTOP FILES

Expanding 13-pocket files with index tabs and inserts. Stitched cloth reinforced edges, elastic closure. Black.

ORDER NUMBER	DESCRIPTION	UNIT
1 201D-13BK	Letter	EA
2 202D-13BK	Legal	EA
3 203D-13BK	Cheque/voucher	EA



F PENDAFLEX® 12"×18" WALLET

Extra large wallet is sized to hold 11"×17" paper. Durable 19pt. front and back covers. Expanding sides feature additional reinforcement at top edges. Paper made with 10% recycled fibre with at least 10% post-consumer fibre.

ORDER NUMBER	DESCRIPTION	UNIT
B1060E	12"×18", 3.5" expansion	EA

Filing – expanding files



A PENDAFLEX® RED FIBRE EXPANDING FILES

Exceptionally durable leather-like red fibre is resistant to spills and moisture. Suitable for portable active files. Reinforced gussets, open top style for easy access. Letter size (12"×10") or legal size (15"×10"). In three styles: alphabetical (A-Z), 21 pockets, monthly (Jan-Dec), 12 pockets, or daily (numbered 1-31) 31 pockets. Paper made with 30% recycled fibre with at least 30% post-consumer fibre.

ORDER NUMBER	DESCRIPTION	UNIT
1	R-17A-0X Letter A-Z	EA
2	R-17D-0X Letter 1-31	EA
3	R-17M-0X Letter Jan/Dec.	EA
4	R-19A-0X Legal A-Z	EA
5	R-19D-0X Legal 1-31	EA
6	R-19M-0X Legal Jan./Dec.	EA



B PENDAFLEX® ESSENTIALS™ KRAFT EXPANDING FILES

Kraft material with reinforced expansion gussets and flap closure. Imprinted partition tabs. Letter size (12"×10") or legal size (15"×10"). Alphabetical (A-Z) – 21 pockets. Daily (1-31) – 31 pockets. Paper made with 10% recycled fibre with at least 10% post-consumer fibre.

ORDER NUMBER	DESCRIPTION	UNIT
1	K-17A-0X Letter, Alphabetical	EA
2	K-17D-0X Letter, Daily	EA
3	K-19A-0X Legal, Alphabetical	EA
4	K-19D-0X Legal, Daily	EA



C PENDAFLEX® EXPANDING WALLETS

Durable red fibre material with protective flap closed with elastic tie, protects files and can be used as a portable file. Rollover reinforced gussets. Available in letter size (11¾"×9½") or legal size (15¼"×10") with choice of expansion. Paper made with 30% recycled fibre with at least 30% post-consumer fibre.

ORDER NUMBER	DESCRIPTION	UNIT
1	E19-4-B Letter 3½" expansion	EA
2	E19-6-B Letter 5¼" expansion	EA
3	E22-2-B Legal 1¾" expansion	EA
4	E22-4-B Legal 3½" expansion	EA
5	E22-6-B Legal 5¼" expansion	EA



D PENDAFLEX® PARTITION WALLETS

Red fibre wallet with elastic cord closure and inner partitions to divide contents. Paper made with 30% recycled fibre with at least 30% post-consumer fibre. Letter size (11¾"×9½") or legal size (15¼"×10").

ORDER NUMBER	DESCRIPTION	UNIT
1	E19-6P-B Letter, 6 pockets, 5¼" cap.	EA
2	E22-4P-B Legal, 4 pockets, 3½" cap.	EA
3	E22-6P-B Legal, 6 pockets, 5¼" cap.	EA



E WINNABLE EXPANDING PORTFOLIO

Front flap and elastic tie to hold documents securely. Features index pocket. 5¼" expansion. Legal size. 15"×10". Black.

ORDER NUMBER	DESCRIPTION	UNIT
328-BK	Legal size	EA



F PENDAFLEX® LEGAL EXPANDING WALLET WITH RUBBER GUSSET

Durable water-resistant poly with black rubber gusset for added sturdiness. Black elastic tie closure keeps contents securely inside. Five-inch expansion.

ORDER NUMBER	DESCRIPTION	UNIT
52536	Legal size	EA

Filing – expanding files



A WINNABLE EXPANDING FASHION DOCUMENT FOLDERS

Business card holder on interior flap. Elastic tie and button closure. 1½" expansion. Leatherine polypropylene. Letter size.

ORDER NUMBER	DESCRIPTION	UNIT
1 20171-BK	Black	EA
2 20172-TN	Tan	EA
3 20173-RD	Burgundy Red	EA



B WINNABLE EXPANDING FASHION FILE

Elastic tie and button closure. Includes index tabs. 13 pockets. Poly. 13"W×12"D×9½"H.

ORDER NUMBER	DESCRIPTION	UNIT
1 20181-BK	Black	EA
2 20182-LV	Lavender	EA

C WINNABLE® EXPANDING FILES

Poly file with 13 pockets, index tabs and inserts. Elastic flap closure. Black.

ORDER NUMBER	DESCRIPTION	UNIT
1 200-12BK	5"×10"	EA
2 201-12BK	10"×12"	EA
3 202-12BK	10"×15"	EA



D PENDAFLEX® 13 POCKET FILE

Help divide and organize contents. Insertable tabs are customizable. Secure elastic closure. Black.

ORDER NUMBER	DESCRIPTION	UNIT
39624BLA	Letter size	EA



E WINNABLE® WINDOWFILE™ PORTABLE EXPANDING FILES

Durable poly with 13 pockets. Includes index tabs. Elastic tie and button closure. Black with blue accents.

ORDER NUMBER	DESCRIPTION	UNIT
1 201WF-12	Letter size	EA
2 202WF-12	Legal size	EA



F CAMBRIDGE® POLY DOCUMENT WALLET

Organize and separate documents. Each tab is attached to a removable poly folder. 6 Tabs. Black.

ORDER NUMBER	DESCRIPTION	UNIT
65800-35198	Letter size, 12¼"×10⅞"	EA



G PENDAFLEX® OPEN TOP FILE

Open top for easy access to contents. Seven pockets help divide content. Snap closure. Blue.

ORDER NUMBER	DESCRIPTION	UNIT
89551BLU	Letter size	EA



H PENDAFLEX® DESK FREE™ HANGING ORGANIZER WITH CASE

Vertical filing system lets you see all important documents. Removable file pockets with index tab for each level. Can be removed from the carry case and stored in a filing cabinet. Ideal for partition or panel hanging.

ORDER NO.	DESCRIPTION	UNIT
52891	Letter size, 9½"×11¾"×½"D	EA



Check online for the most current price.

NEW!



A U BRANDS® FASHION EXPANDING FILE

Open top for easy access to contents. Features tear proof poly shell and secure closure. Holds letter size documents. 5 pockets. 13"W×9³/₁₀"D×1"H. Navy Dots.

ORDER NUMBER	UNIT
3307F06-24	EA

NEW!



B U BRANDS® CASCADING WALL ORGANIZER

Provides organization for all home, office or classroom filing needs. Individual removable files. 6-Tier. 34"×14". Letter size. Polypropylene. Assorted Primary Colours.

ORDER NUMBER	UNIT
4366F04-24	EA



C WINNABLE EXPANDING ENVELOPES

Designed with an elastic tie to secure documents. 1¹/₂" expansion.

ORDER NUMBER	DESCRIPTION	UNIT
1 321-BE	Letter, Blue	EA
2 321-CR	Letter, Clear	EA
3 322-BE	Legal, Blue	EA
4 322-CR	Legal, Clear	EA



D PENDAFLEX® FELT POCKETS

A modern take on a heritage style. Felt pocket revives a timeless design. Can hold a variety of items such as files, tablets or odds and ends. Charcoal and black.

ORDER NUMBER	DESCRIPTION	UNIT
1 99860	11 ¹ / ₈ "×14"×1" expansion, Snap closure	EA
2 99882	10 ¹ / ₄ "×11 ¹ / ₂ " 1 ¹ / ₂ " expansion, Button & String closure	EA
3 99877	8"×9 ¹ / ₈ "×1" Zipper closure	EA



E WINNABLE® COIL BOUND EXPANDING FILE

Flexible flap opening with coil hinge. Accepts letter size documents; 13 pockets with tab dividers.

ORDER NUMBER	DESCRIPTION	UNIT
20122	Letter, 13"×10 ¹ / ₂ "×1 ¹ / ₂ ", Grey	EA



F PENDAFLEX® POLY PROFESSIONAL DOCUMENT FILE

Metallic pewter with black stitched cloth trim. Full flap with elastic closure, 13 pockets with index tabs and inserts, letter size.

ORDER NUMBER	DESCRIPTION	UNIT
52474C	13.12"×9.63"×1.5"	EA

G U BRANDS® PERFORMANCE EXPANDING FILE

Protect your documents from the outdoors. Never worry about losing your important documents thanks to the secure elastic and button closure. 12 pockets. Polypropylene. 13"W×2"D×9¹/₂"H. Olive.

ORDER NUMBER	UNIT
4358F04-24	EA

NEW!





A WINNABLE® PORTABLE FILE

Letter/legal size; with index tabs and inserts. Sewn cloth binding and pop-up handle.

ORDER NUMBER	DESCRIPTION	UNIT
150-12BK	Black, 13 pockets	EA



B PENDAFLEX® PORTAFILE™

19 filing pockets hold letter or legal size documents. Home and A-Z pre-printed tabs easily organize home, school or office papers. Paper made with 10% recycled fibre with at least 10% post-consumer fibre. 10³/₈"H×15¹/₈"W×5¹/₄"D.

ORDER NUMBER	DESCRIPTION	UNIT
1 01156	Black	EA
2 01159	Green	EA
3 01157	Purple	EA
4 01160	Turquoise	EA



C STOREX® COLLAPSIBLE CRATE

Lid snaps on crate even when collapsed. Completely stackable with or without lid. Holds letter & legal size hanging files. 14¹/₄"W×17¹/₄"D×10¹/₂"H. Black.

ORDER NUMBER	UNIT
61809U04C	EA



D STOREX® PORTABLE FILE BOX WITH TOP ORGANIZER

Lightweight and portable; accommodates files and hanging folders. Large compartment in lid holds pens, paper clips and other supplies. Made with 50% post-consumer recycled material. Can be stacked. Black.

ORDER NUMBER	DESCRIPTION	UNIT
1 61504B03C	Letter, 13 ¹ / ₂ "W×11"D×12 ¹ / ₂ "H	EA
2 61510B04C	Legal/Letter, 17"W×9"D×11 ¹ / ₂ "H	EA

E MERANGUE® COLLAPSIBLE BIN STORAGE

Strong, durable construction. Collapsible storage bin holds letter size hanging folders or can store just about anything, then fold nicely away when not in use. Ideal for portability and storage. Black.



ORDER NUMBER	UNIT
1025-3181-20-000	EA

F STOREX® PREMIUM CRATE WITH HANDLES

Rugged dependability with solid bottom, easy grip handles, and improved drop test performance. Holds letter or legal hanging files and folders. Modular design allows for custom stacked storage solutions. Stackable in any direction. PVC & BPA free. 14¹/₄"W×17¹/₄"D×10¹/₂"H. Black/White.



ORDER NUMBER	UNIT
61788U03C	EA

Filing – portable files



A BANKERS BOX® HEAVY DUTY PLASTIC BIN

Organize and secure storage for transport. Reinforced corners for added strength and stackability. Built-in hanging rails keeps files organized and accessible. Comfortable handles on either side offers easy lifting with locking lid. 29 L. Letter or Legal size. 14 $\frac{1}{8}$ "W×17 $\frac{3}{8}$ "D×10 $\frac{1}{8}$ "H. Clear.

ORDER NUMBER	UNIT
0086207	EA



C BANKERS BOX® STORAGE BOXES

Keep your contents dust and moisture free, clip-lock clamps securely lock the lid in place. Double reinforced sides and base. Clear.

ORDER NUMBER	DESCRIPTION	UNIT
1 7730103	1.7L capacity, 7 $\frac{9}{16}$ "W×5"D×4 $\frac{1}{8}$ "H	EA
2 7730203	2.6L capacity, 9 $\frac{2}{5}$ "W×5"D×5 $\frac{1}{2}$ "H	EA
3 7730302	5.5L capacity, 16"W×10 $\frac{5}{8}$ "D×4 $\frac{1}{2}$ "H	EA
4 7730405	10L capacity, 15 $\frac{5}{8}$ "W×10"D×6"H	EA



B BANKERS BOX® HEAVY DUTY PORTABLE FILE BOX

Provides organized and secure storage and transport of documents. Lid features a handy organizer compartment. Built-in hanging rails. Latching lid. 14 L. Letter size. 14 $\frac{1}{4}$ "W×8 $\frac{5}{8}$ "D×11 $\frac{1}{8}$ "H. Plastic. Clear/Blue.

ORDER NUMBER	UNIT
0086302	EA



D CEP FOLDING CRATES

Strong and light folding crate. Can be easily folded and unfolded, saving space during storage and transport. Folds down to 1 $\frac{3}{4}$ " high for easy storage. Black and Grey.

ORDER NUMBER	DESCRIPTION	UNIT
1 31015	32L capacity, 13 $\frac{4}{5}$ "W×18 $\frac{7}{10}$ "D×9 $\frac{2}{5}$ "H	EA
2 31165	45L capacity, 14 $\frac{5}{8}$ "W×20 $\frac{9}{10}$ "D×10 $\frac{3}{5}$ "H	EA

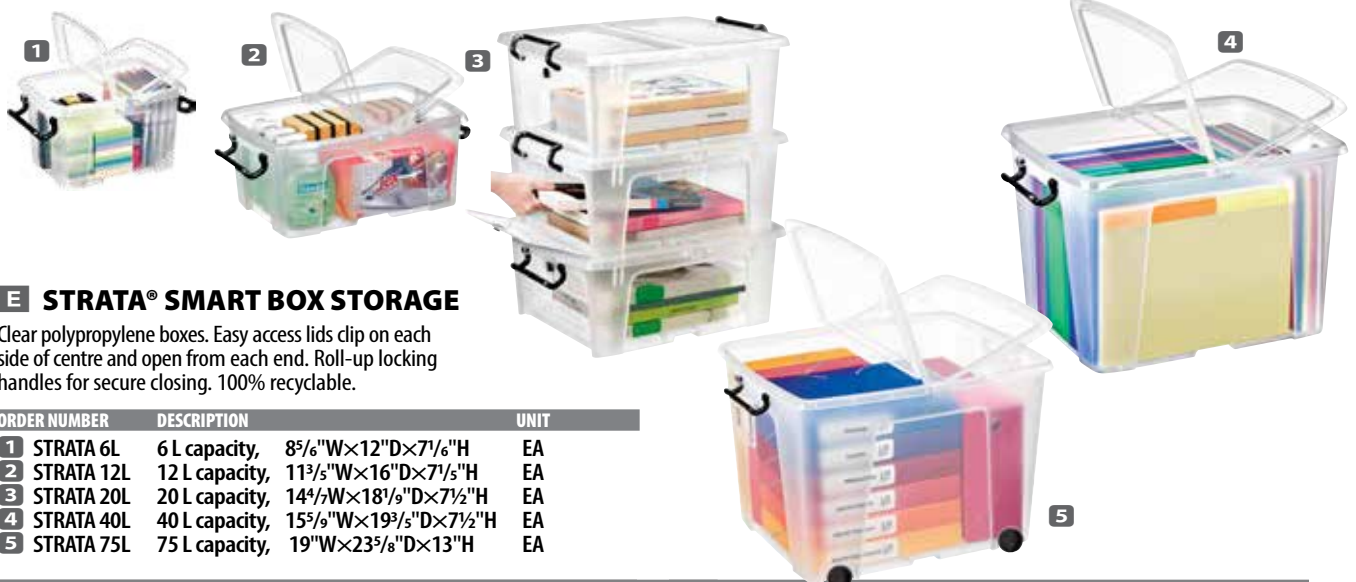

E STRATA® SMART BOX STORAGE

Clear polypropylene boxes. Easy access lids clip on each side of centre and open from each end. Roll-up locking handles for secure closing. 100% recyclable.

ORDER NUMBER	DESCRIPTION	UNIT
1 STRATA 6L	6 L capacity, 8 $\frac{5}{16}$ "W×12"D×7 $\frac{1}{8}$ "H	EA
2 STRATA 12L	12 L capacity, 11 $\frac{3}{5}$ "W×16"D×7 $\frac{1}{5}$ "H	EA
3 STRATA 20L	20 L capacity, 14 $\frac{4}{7}$ "W×18 $\frac{1}{9}$ "D×7 $\frac{1}{2}$ "H	EA
4 STRATA 40L	40 L capacity, 15 $\frac{5}{9}$ "W×19 $\frac{3}{5}$ "D×7 $\frac{1}{2}$ "H	EA
5 STRATA 75L	75 L capacity, 19"W×23 $\frac{5}{8}$ "D×13"H	EA



A STOREX® LETTER/LEGAL FILE TOTE

Holds letter or legal hanging folders. Clear cover. Made with 25% post-consumer material. 14½"W×19½"D×11½"H.

ORDER NUMBER	DESCRIPTION	UNIT
61542B04C	Blue	EA



B STOREX® FLIP TOP STORAGE TOTE

Swing-top, inter-connecting lid is always attached to the base. Units can be stacked when lid is closed. Contains 100% post-consumer recycled material. 45 L. For letter or legal size hanging folders or files. 20"W×15"D×12"H. Clear with Black top

ORDER NUMBER	DESCRIPTION	UNIT
00903U04C	Clear	EA



C STOREX® LOCKING HANDLE LETTER/LEGAL FILE UTILITY TOTE

Moisture resistant to protect your files from damage. Stacks up to 6 high. Built-in handles and a snap-on lid. Contains a minimum of 25% post-consumer recycled material. Built-in rails for letter or legal hanging folders. 14"W×18¼"D×10½"H.

ORDER NUMBER	DESCRIPTION	UNIT
61563B04C	Black	EA



D STOREX® LETTER/LEGAL GRIP AND GO FILE TOTE

Built-in locking handles in lid. Made with 25% post-consumer material. 20"W×12"D×14"H.

ORDER NUMBER	DESCRIPTION	UNIT
1 61530B04C	Clear	EA
2 61543B04C	Black	EA



E STOREX® PORTABLE LETTER/LEGAL FILE TOTE

Built-in rails for hanging folders. Contains a minimum of 25% post-consumer recycled material. Built-in comfort grip handles. 13.9"W×18.34"D×10.56"H.

ORDER NUMBER	DESCRIPTION	UNIT
61528B04C	Black	EA



F STOREX® LETTER/LEGAL FILE TOTE

Comfort grip handles make this box ideal for travel. Heavy duty plastic construction. For letter or legal size files. Stacks up to 6 high. 18"W×14"D×11½"H.

ORDER NUMBER	DESCRIPTION	UNIT
61508B04C	Clear	EA

Filing – mobile cabinets and file carts



A STOREX® DELUXE CABINET WITH ROLL-TOP COMPARTMENT

Durable metal on plastic cabinet incorporates a supply organizer with a handy rollaway supply cover. Features locking drawers for added security. Includes four casters (2 locking). For letter size files; 15"W×19"D×23"H.



ORDER NUMBER	UNIT
61352B01C	EA



B STOREX® FILING CABINET

Heavy-duty plastic construction. Two drawers, key lock with built-in rails for hanging files. Accommodates letter and legal size files. Roller drawers for easy sliding. Includes casters. 15"W×18"D×26"H.



ORDER NUMBER	DESCRIPTION	UNIT
1 61301B01C	Grey	EA
2 61309B01C	Black	EA



C SAFCO® ROLLING FILE CARTS

Both carts feature sturdy steel construction with a scratch resistant black powder coat finish, four swivel casters (2 locking) and easy assembly. One-tier file cart (#5277) tucks under most work surfaces and accommodates 50 letter or 40 legal size folders (not included). Bottom shelf provides additional storage. Two-tier cart (#5278) allows letter size folders to be placed in two rows side by side or one lengthwise row on each frame. Bottom shelf can also be used for storage. Greenguard certified.

ORDER NUMBER	DESCRIPTION	UNIT
1 5277BL	1-tier, 15½" W×14" D×19¾" H	EA
2 5278BL	2-tier, 25¾" W×14" D×29¾" H	EA



D SAFCO® MOBILE FILE

Functional, versatile, file cart designed to accommodate letter or legal size file folders. Additional end pockets for active files. Oversize swivel casters for easy mobility. Carts slide under worksurface when not in use. Greenguard certified.

ORDER NUMBER	DESCRIPTION	UNIT
5373BL	Scout™, 28" W×14¾" D×26" H	EA

E SAFCO® ONYX™ MESH MOBILE FILE

Tubular steel frame cart with letter size file cube and two storage drawers to hold all your office essentials. Fits under desk or worksurface. Top shelf provides additional space for files or office supplies. Greenguard certified. Dimensions: 15¾" W×17" D×27" H.



ORDER NUMBER	UNIT
5213BL	EA

F GLOBE™ UTILITY CART

Ideal for an office, restaurant, healthcare facility or hotel. Strong sturdy handles and 4" rubber casters. Accommodates up to 200 lbs. 17"W×33"D×37"H. Black.



ORDER NUMBER	UNIT
5001GCP	EA

Our Brand, YOUR Savings!



A OP BRAND STORAGE BOX

With 50% post-consumer content. Accommodates both letter and legal size folders; lift-off lid. Maximum stacking weight: 400 lbs. White.



B OP BRAND RECYCLED HEAVY DUTY STORAGE BOX

With lift-off lid. Contains 50% recycled post-consumer material; 850 lbs stacking strength. For letter or legal size files.

ORDER NUMBER	DESCRIPTION	UNIT
27811-30014	12" W×15" D×10" H	6/PK

ORDER NUMBER	DESCRIPTION	UNIT
1 27811-30016	12" W×15" D×10" H	12/CT
2 27811-30017	12" W×15" D×10" H	4/PK



C BANKERS BOX® STOR/FILE™

Economical construction with white finish, lift-off lid and built-in handles. Printed label area for use with letter or legal size file folders. Contains 60% recycled/50% post-consumer material; SFI certified. Shipped flat. Stacking weight: 450 lbs. Easily assembled.

ORDER NUMBER	DESCRIPTION	UNIT
1 77511-00772	12" W×15" D×10" H	25/CT
2 77511-07727	12" W×15" D×10" H	6/PK



D BANKERS BOX® FASTFOLD™ R-KIVE® SERIES

Holds letter and legal size folders. Great to colour code files. Contains 60% recycled/50% post-consumer material; SFI certified. Stacking weight: 850 lbs. Twelve per carton, 10"×12"×15".

ORDER NUMBER	DESCRIPTION	UNIT
1 77511-00724	White/black	EA
2 77511-07241	White/green	EA
3 77511-07242	White/red	EA
4 77511-07243	White/blue	EA
5 77511-00725	Woodgrain	12/CT



E BANKERS BOX® BINDERBOX™ STORAGE BOX

Double bottom, triple end, double side construction. Sized to top-load eight full 2" binders. FastFold™ easy one-step assembly, reinforced hand holes and a locking lift-off lid. Contains 60% recycled/50% post-consumer material; SFI certified. Stacking weight: 850 lbs.

ORDER NUMBER	DESCRIPTION	UNIT
0073301	12¼" W×12" H×18½" D	12/CT



F BANKERS BOX® STOR/FILE™ BOX FILES

Economical, recycled, corrugated files with lift-off lid and built-in carrying handles for semi-active or dead files. Contains 60% recycled/50% post-consumer material; SFI certified. Stacking weight: 650 lbs. (00701) and 700 lbs (00702). Shipped ready to assemble.

ORDER NUMBER	DESCRIPTION	UNIT
1 77511-00701	12"×10"×24" D, letter	EA
2 77511-00702	15"×10"×24" D, legal	EA

Our Brand, YOUR Savings!



A OP BRAND 100% RECYCLED LETTER/LEGAL STORAGE BOX

With 100% recycled post-consumer content. Accommodates both letter and legal size folders; lift-off lid. Maximum stacking weight: 400 lbs.; strong base to hold many files.

ORDER NUMBER	DESCRIPTION	UNIT
27811-30019	12" W×15" D×10" H	6/PK



B OP BRAND RECYCLED STORAGE BOX WITH ATTACHED LID

Flip-top lid. Contains a minimum of 100% recycled material; 350 lbs stacking strength. Strong base to hold many files. For letter or legal size files. FSC™ certified.

ORDER NUMBER	DESCRIPTION	UNIT
27811-30015	12" W×15" D×10" H	25/PK

OFFICE SUPPLIES



C BANKERS BOX® EARTH SERIES™ STOR/FILE™ STORAGE BOXES

100% recycled material. Locking lid. Kraft/green. Stacking strength: letter 650 lbs.; legal 700 lbs. SFI-certified.

ORDER NUMBER	DESCRIPTION	UNIT
1 1270101	Letter, 12" W×24" D×10" H	EA
2 1270201	Legal, 15" W×24" D×10" H	EA



D BANKERS BOX® ENVIRO STOR™ FILE BOX

With attached hinged lid. Shipped ready to assemble. Contains 100% recycled material.



ORDER NUMBER	DESCRIPTION	UNIT
77511-00872	Letter/Legal size, 12" W×15" D×10" H	EA



E BANKERS BOX® ROLL-STOR® STAND

Safe, convenient storage for rolled documents. Durable floor unit in corrugated material with woodgrain appearance and plastic trim; 20 compartments. Shipped ready to assemble. Contains 60% recycled/50% post-consumer material; SFI certified. Dimensions: 15¼" W×12¼" D×21¾" H.



ORDER NUMBER	UNIT
77511-20220	EA



F BANKERS BOX® EASYLIFT™ STOR/FILE™

Storage boxes are 20% lighter when full than a standard letter/legal box to eliminate heavy lifting. 400 lb. stacking strength. Double bottom, double end, single side construction. Contains 60% recycled/50% post-consumer material.



ORDER NUMBER	DESCRIPTION	UNIT
0006301	12" W×12" D×10" H	EA

DID YOU KNOW...

COLOUR BAR IDENTIFIES THE STRENGTH OF BOX.



HEAVY



MEDIUM



LIGHT



**A SPICERS
READYPACK™ STORAGE BOXES**

Easy to assemble boxes with an 80% smaller footprint than a standard box and with cut out handles. Flip-top lid. Letter or legal size. 12"W×15"D×10"H. 12 boxes/pkg.

Kraft contains a minimum of 70% post-consumer recycled material. 400 lb. stacking strength.

White contains a minimum of 80% post-consumer recycled material. 650 lb. stacking strength.

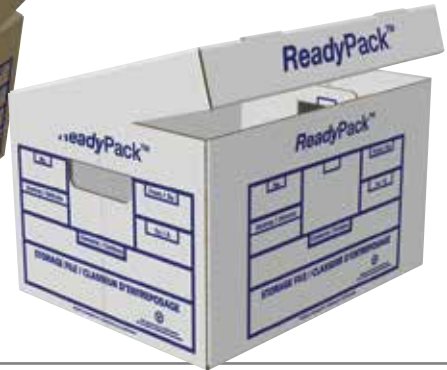

ORDER NUMBER	DESCRIPTION	UNIT
1 SHIC0715K	Kraft	12/PK
2 SHIC0716W	White	12/PK



**B BANKERS BOX®
STAX-ON-STEEL®
STORAGE DRAWERS**

Space-saving stackability with the accessibility of a filing cabinet. Stacks up to 10 units high. Interlocking vertical and horizontal steel framework. Reinforced front and back drawer panels; easy assembly; SFI certified. Includes drawer handle/index card holder and index cards. Metal bases protect your files by raising them 2" above floor level and help prevent damage from kicks, cleaning equipment and moisture. Drawers contain 60% recycled/50% post-consumer material. SFI-certified.



**C BANKERS BOX®
EARTH SERIES™ STOR/DRAWER® STEEL PLUS™
TRANSFER FILES**

Features steel reinforced inner shell. 100% post-consumer recycled materials. Stackable up to 5 high. SFI-certified.

ORDER NUMBER	DESCRIPTION	UNIT
1 77511-00511	Letter, 11.13" H×14" W×25.5" D	EA
2 77511-00512	Legal, 11.13" H×17" W×25.5" D	EA

ORDER NUMBER	DESCRIPTION	UNIT
1 1231101	Letter size, 11½" H×14" W×25½" D	EA
2 1231201	Legal size, 11½" H×16¾" W×25½" D	EA



**D BANKERS BOX®
EARTH SERIES™
STOR/DRAWER®
TRANSFER FILES**

Convenient storage for cheque, letter or legal files. 24" deep. Durable construction from 100% recycled/100% post-consumer material. Designed for use on shelves. Shipped flat. Easy to assemble. SFI-certified.



ORDER NUMBER	DESCRIPTION	UNIT
1 77511-00202	Cheque, 5¼" H×10½" W×25¼" D	EA
2 77511-00211	Letter, 11½" H×14" W×25½" D	EA
3 77511-00212	Legal, 11½" H×16¾" W×25½" D	EA



**E STOREX®
STORAGE FILE
DRAWER SYSTEM**

Solid plastic construction with plastic rollers on drawers for smooth operation. Stackable up to 10 units high with secure interlocking system. Accommodates hanging files with built-in rails. Grey/Black. Letter size: 15" W×24¼" D×11½" H. Legal size: 17⅞" W×24⅞" D×11¼" H.



ORDER NUMBER	DESCRIPTION	UNIT
1 61106B01C	Letter Size	EA
2 61402B01C	Legal Size	EA



Our Brand, YOUR Savings !



A OP BRAND RECYCLED BINDING CASES

Tough fibreboard outer case and inner jacket. Sturdy 2¾" centre arch wires, reinforced finger pull. Contains 100% recycled, 20% post-consumer material. Shipped flat.



ORDER NUMBER	DESCRIPTION	UNIT
1 27811-20025	Letter, 2¾" W×10" D×8½" H	6/PK
2 27811-20026	Legal, 2¾" W×14" D×8½" H	6/PK



C ACCO® BINDING CASES

These durable recycled fibreboard cases feature heavy duty arch wires, reinforced finger pull and large label area. Stores up to 3½" capacity. 2¾", two-hole punched paper. Contains 100% recycled, 85% post-consumer material.



ORDER NUMBER	DESCRIPTION	UNIT
1 50505-14054	Invoice, 10¼"×9"	6/PK
2 50505-14064	Letter, 12½"×9"	6/PK
3 50505-14074	Legal, 15½"×9¼"	6/PK
4 50505-14084	Note, 12½"×7½"	6/PK
5 50505-14094	Prescription, 8¾"×5½"	6/PK

F GLOBE-WEIS® PRESTONIA® TRANSFER CASES

A solid and durable side-opening file to give easy access to file folders. Large end label for identification. File capacity: 4½". Two sizes; shipped assembled.



ORDER NUMBER	DESCRIPTION	UNIT
492 WA	Legal size	EA

B SAFCO® MOBILE STAND

Self-contained storage system for drawings and plans. Steel construction, 3" ball bearing swivel casters. Up to 12 hanging clamps (available separately) pivot freely from side to side on pivot brackets (included). Adjustable height (43½" to 61½") and base (27½" to 37½"); 27" wide. Quick and easy assembly. Colour: Tropic Sand. Greenguard certified.



ORDER NUMBER	UNIT
5026	EA

D SAFCO® DROP LIFT WALL RACK

Lift out/drop in convenience. Compact design – extends out less than 12" yet holds up to 12 hanging clamps (sold separately). Holds up to 1200 sheets. Includes mounting hardware. Recommended installation on wall studs or solid-back wall surfaces. Colour: Tropic Sand. Greenguard certified.



ORDER NUMBER	DESCRIPTION	UNIT
5030	1¼"W×11¾"D ×7⅞"H	EA



E SAFCO® HANGING CLAMPS

Extruded aluminum clamps each hold up to 100 sheets or 20 lbs. Lifetime guarantee on clamps, plastic hangers and wing knobs. Greenguard certified.

ORDER NUMBER	DESCRIPTION	UNIT
1 50026	24"×36"	EA
2 50036	30"×42"	EA
3 50046	36"×48"	EA

G STAEDTLER® EXPANDABLE STORAGE TUBE

Telescopic tube, adjustable from 72-124 cm (app. 29"-50"). Screw-on cap and adjustable shoulder strap. Locks at 10 different lengths, 8 cm diameter, black.



ORDER NUMBER	DESCRIPTION	UNIT
948 72 124 NA	Expandable tube	EA

Filing – book, magazine and literature organizers

A WINNABLE® STEEL BOOKENDS

Durable steel construction with scratch and chip resistant finish. Reinforced rib design adds side strength and stability. Foam pad on base prevents sliding and scratching. Black.



ORDER NUMBER	DESCRIPTION	UNIT
1 12333	9" H × 6" W	PR
2 12332	5" H × 4¾" W	PR



B STOREX® MAGAZINE FILE

Made from 100% post consumer material.



ORDER NUMBER	DESCRIPTION	UNIT
70168U06C	4" W × 9½" D × 11½" H	2/PK



C STOREX® BOOK BINS

Book Bin will hold large books, magazines, file folders, etc. Sides of bins connect together for safe storage and have front and rear handles for easy gripping. 14" L × 5¼" W × 7¼" H.

ORDER NUMBER	DESCRIPTION	UNIT
1 70105U06C	Assorted colours	5/PK
2 70109B06C	Black	EA



D BANKER'S BOX® 4" MAGAZINE FILE HOLDERS

Stores and organizes letter size materials – holds magazines, catalogues, file folders, project binders and text books. Perfect for shared classroom storage or teacher's desktop storage. Dimensions: 12¾" H × 4" W × 11" D. Contains 60% recycled material.



ORDER NUMBER	DESCRIPTION	UNIT
3381701	Red, Blue and Yellow	3/PK

E RUBBERMAID® MAGAZINE HOLDER

Perfect for organizing and storing magazines, catalogues, manuals and hobby books. Fits all standard 3-ring binders. No holes to punch.



ORDER NUMBER	UNIT
T02802	12/CD

F BANKERS BOX® MAGAZINE FILES

Corrugated with wood grain finish for magazines, periodicals or telephone directories.



ORDER NUMBER	DESCRIPTION	UNIT
1 77511-07223	4" W × 11½" H × 9" D	EA
2 77511-07224	4" W × 12¼" H × 11" D	EA

G STOREX® TWELVE-COMPARTMENT LITERATURE ORGANIZER

Plastic construction; stackable up to six units high. Removable clear tab covers allow each compartment to be labelled. 31¾" W × 14¾" D × 10¾" H.

ORDER NUMBER	DESCRIPTION	UNIT
61602B01R	Black	EA

H BANKERS BOX® DECORATIVE LITERATURE SORTER

For organizing mail, forms, catalogue sheets and other letter size documents. Includes plastic channels and labels for indexing. Compartment dimensions: 2¾" H × 9" W × 12" D; overall dimensions: 10¼" H × 19½" W × 12¾" D.

ORDER NUMBER	DESCRIPTION	UNIT
6170301	Pinstripe	EA



A WINNABLE® DESK ACCESSORIES

Durable black mesh for a contemporary look.

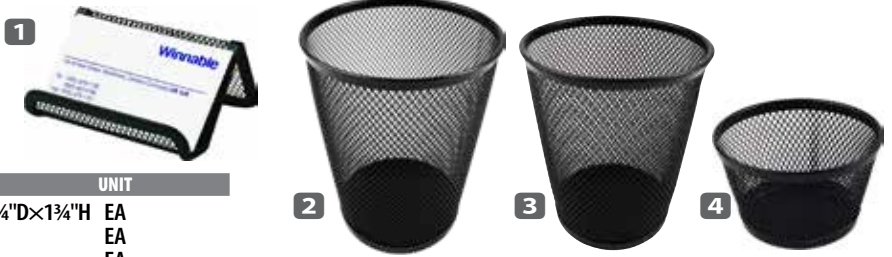

ORDER NUMBER	DESCRIPTION	UNIT
1 12251	Business card holder, 3¾"W×2¾"D×1¼"H	EA
2 12301*	Pencil cup, 4¼"×4¼"×5½"	EA
3 12221*	Pencil cup, 4"×4"×4½"	EA
4 12241*	Paper clip holder, 3½"×3½"×2"	EA

* Nestable design

B WINNABLE® FILING CONTAINERS

Black mesh complements desk accessories, trays and organizers.



ORDER NUMBER	DESCRIPTION	UNIT
1 11951	Wall file, 14"W×8½"H×3⅜"D	3/PK
2 12261	Magazine file, 2¾"W×12⅜"H×9¾"D	EA
3 12262	Jumbo magazine file, 6"W×12½"H×9½"D	EA
4 12271	Three-tier organizer, 12⅝"W×3½"D×11½"H	EA

C WINNABLE® MAGNETIC MESH FILE HOLDERS

With strong magnets on back to hold file securely to metal surfaces. Letter size; Black.

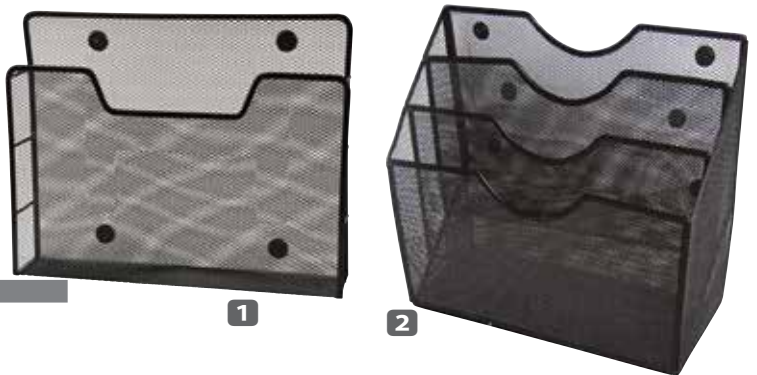

ORDER NUMBER	DESCRIPTION	UNIT
1 14530	Single, 12"×2½"×9¼"H	EA
2 14531	Triple, 12"×4"×11½"H	EA

D WINNABLE® DESKTOP TRAYS

Black mesh document trays in 4 different configurations. Stackable, except 3-tier.

ORDER NUMBER	DESCRIPTION	UNIT
1 12211	11"W×13¼"D×2⅝"H, front loading	EA
2 12321	14½"W×10¼"D×2⅝"H, side loading	EA
3 12326	15½"W×10⅝"D×2½"H, side loading	EA
4 12341	12½"W×9¾"D×12½"H, 3-tier	EA

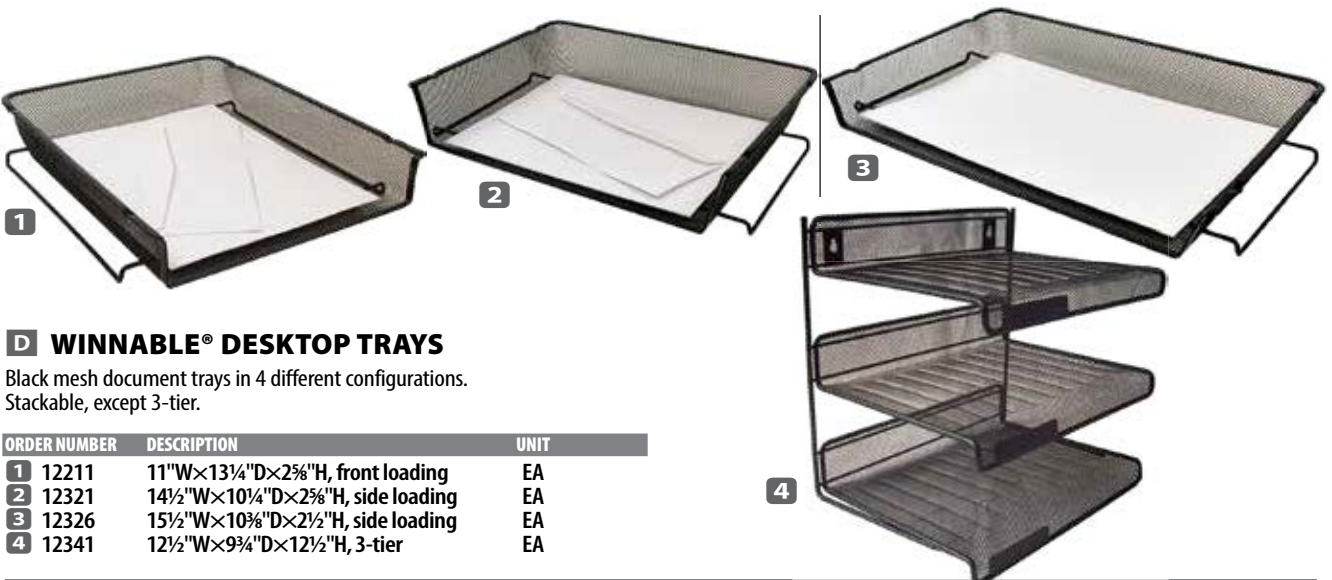

Workspace Organization – desk accessories



A WINNABLE® DESKTOP ORGANIZERS

A large selection of space-saving organizers for all your desktop needs. Black mesh.

ORDER NUMBER	DESCRIPTION	UNIT
1	Desk organizer, 5¾" W×5" D×5" H	EA
2	Desk organizer, 11" W×5¼" D×5" H	EA
3	Desk organizer, 10" W×5¼" D×1½" H	EA
4	Step sorter, 7" W×8½" D×7" H	EA
5	Desk tray with sorter, 16½" W×9" D×6½" H	EA
6	Mini sorter, 6⅞" W×3¼" D×5⅞" H	EA
7	Five-section sorter, 14¾" W×8" D×7½" H	EA
8	Mesh file and tray sorter 11½" W×12½" D×9½" H	EA
9	Step file organizer, 10½" W×8¼" D×12" H	EA
10	Phone stand, 11½" W×10" D×5" H	EA
11	Monitor/printer stand, 20" W×11¾" D×5¾" H	EA



OFFICE
SUPPLIES



B WINNABLE® MESH WASTEBASKETS

Two styles to complement any office decor. Black.

ORDER NUMBER	DESCRIPTION	UNIT
1	Round, 11⅞" D×13¾" H	EA
2	Square, 10½" W×10½" D×14" H	EA

BOSTITCH® FEATURE

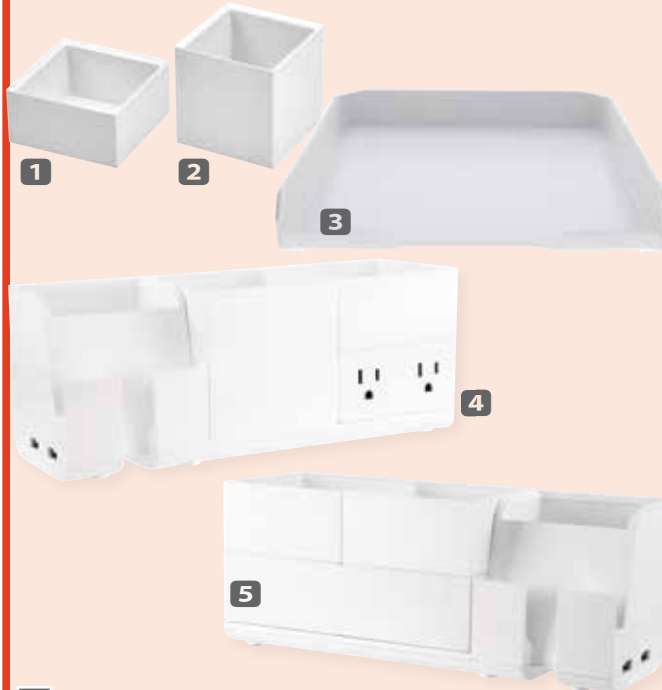

A BOSTITCH® KONNECT™ DESK ORGANIZER AND POWER SYSTEMS

ORDER NUMBER	DESCRIPTION	UNIT
1	KT2-SMCUP-WHT Storage Tray, 3½"W×3½"D×2"H	EA
2	KT2-TLCUP-WHT Pencil Cup, 3½"W×3½"D×3⅝"H	EA
3	KT-TRAY-WHITE Letter Tray, 10¼"W×12¼"D×1⅝"H	EA
4	KT2-BASEKIT1-WHT Desk Organizer with Power, 10½"W×4⅜"D×4⅜"H	EA
5	KT2-BASEKIT2-WHT Desk Organizer, 10½"W×4⅜"D×4⅜"H	EA



B ELLYPSE OWA BY CEP RECYCLED DESK ACCESSORIES

Accessories manufactured from 100% recycled and 100% recyclable material. Made from used printer cartridges and production scrap material. 100% recyclable. Shock-resistant polystyrene. Black.

ORDER NUMBER	DESCRIPTION	UNIT
1	CEP300 EO Letter Tray 10.8"W×15"D×3.2"H	EA
2	CEP340 EO Pencil Cup 3.5"W×4.6"D×3.9"H	EA
3	CEP350 EO Step Sorter 8.9"W×5.1"D×5"H	EA
4	CEP370 EO Magazine Rack 3.3"W×11"D×12.8"HEA	EA



C MERANGUE BAMBOO DESK ACCESSORIES

Sleek and stylish. Bamboo.

ORDER NUMBER	DESCRIPTION	UNIT
1	1025-0450-00-000 Tray, 14¼"W×4"W×1¼"H	EA
2	1025-0460-00-000 Holder with drawer, 7¾"W×4"W×3¾"H	EA
3	1025-0420-00-000 Pencil holder, 3½"W×4"W×4¼"H	EA



D ELLYPSE BY CEP DESK ACCESSORIES

Accessories with clean lines that are both solid and practical. 100% recyclable. Shock-resistant polystyrene. Crystal Clear.

ORDER NUMBER	DESCRIPTION	UNIT
1	CEP300 Letter Tray 10.8"W×15"D×3.2"H	EA
2	CEP340 Pencil Cup 3.5"W×4.6"D×3.9"H	EA
3	CEP350 Step Sorter 8.9"W×5.1"D×5"H	EA
4	CEP370 Magazine Rack 3.3"W×11"D×12.8"H	EA

A SAFCO® ONYX™ MESH TELEPHONE STAND

Features angled platform and storage drawer with adjustable, removable divider. Additional storage for notebooks, paper, etc. underneath. Greenguard certified.



ORDER NUMBER	DESCRIPTION	UNIT
2160BL	11¾" W×9¼" D×7" H	EA

NEW!

B VICTOR® WIRELESS PHONE CHARGER WITH PENCIL CUP

Angled ledge to rest your phone on while wirelessly charging and a large pencil cup for storing your writing utensils. Non-slip rubber feet reduce movement and protect your surface. Includes 59" USB cable. Black MDF wood.



ORDER NUMBER	DESCRIPTION	UNIT
CS100	37/10" W x 52/5" D x 45/8" H	EA

C DEFLECTO® SILHOUETTES® ALL-IN-ONE CADDY

Combines function of multiple desk accessory items into a single unit. Built-in tape dispenser (tape not included). Dedicated compartment for cell phones/MP3 player cord to run underneath product while devices are charging. Black.



ORDER NUMBER	DESCRIPTION	UNIT
35172	8½" W×9½" D×5¾" H	EA

D ACCO® MAGNETIC PAPER CLIP DISPENSER

Plastic with removable magnetic top. Clear and Black. 1¾" W×1¾" D×2¾" H.



ORDER NUMBER	UNIT
50505-72351	EA

E STOREX® DESK ORGANIZER

Durable and economical. Contains 100% post-consumer recycled content. Plastic. Black.



ORDER NUMBER	DESCRIPTION	UNIT
70163U06C	6¼" D×6¼" D×4" H	EA

F WESTCOTT® REVOLVING ORGANIZER

Plastic multi-compartment space-saving unit. Black.



ORDER NUMBER	DESCRIPTION	UNIT
65956-81010	7¾" diam. × 8¼" H	EA



G RUBBERMAID® REGENERATION™ NINE SECTION DRAWER ORGANIZER

Uniquely shaped sections hold everything from long scissors to odds and ends. Contains a minimum of 70% post-consumer recycled material. Black.



ORDER NUMBER	DESCRIPTION	UNIT
45706	14" W×9¾" D×1½" H	EA

H RUBBERMAID® DRAWER ORGANIZER

Features extra-capacity 2¼" deep bins so you can organize everything. Black.



ORDER NUMBER	DESCRIPTION	UNIT
11906R05	15" W×11½" D×2½" H	EA

Workspace Organization – desktop organizers

A SAFCO® ONYX™ MESH DESK ORGANIZER

Stay on top of the desk top clutter and keep hard-to-organize folders and binders handy. Two horizontal letter size file trays and six vertical 2" wide file sections. Greenguard certified. Black.

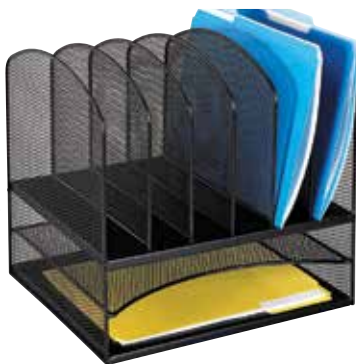

ORDER NUMBER	DESCRIPTION	UNIT
3255BL	13¼"W×11½"D×13"H	EA

B SAFCO® ONYX™ MESH DESK ORGANIZER

Features 3 horizontal letter-sized trays and three 2" wide, upright file sections on the left. The durable steel mesh design aids in office supply organization and file storage. Greenguard certified. Black



ORDER NUMBER	DESCRIPTION	UNIT
3254BL	19½"W×11½"D×8¼"H	EA

C SAFCO® ONYX™ MESH ORGANIZER

Three drawers for small items like pencils, scissors and rulers; side compartments hold pads and envelopes. Sturdy mesh construction with black powder coat finish. Greenguard certified.



ORDER NUMBER	DESCRIPTION	UNIT
3252BL	16"W×11½"D×8¼"H	EA

D SAFCO® ONYX™ MESH DESK ORGANIZER

3 vertical sections for file folders or binders. Store small items in 2 slide-out baskets for easy access. Side shelves for small electronics or miscellaneous accessories. Black.



ORDER NUMBER	DESCRIPTION	UNIT
3263BL	17"W×6¾"D×7¾"H	EA

E MERANGUE® MESH DOCUMENT TRAY

Trays slide in and out for easy access to documents. 3-Tiered. Black.



ORDER NUMBER	DESCRIPTION	UNIT
1025-4252-20-000	14 ¹¹ / ₆₄ "W×2 ¹⁵ / ₆₄ "D×11 ¹³ / ₁₆ "H	EA

F MERANGUE® METAL HORIZONTAL / VERTICAL SORTER

Three horizontal letter size sections and three vertical sections. Scratch and chip-resistant. Non-skid, no-scuff feet to protect surfaces. Black.



ORDER NUMBER	DESCRIPTION	UNIT
1025-0482-00-000	15"W×11"D×8 ¹ / ₁₆ "H	EA

G SAFCO® STEEL DESK TRAY SORTER

Greenguard certified. Features 6 tiered, slanted shelves, notched for convenient access to contents. Black powder coat finish. Greenguard certified.



ORDER NUMBER	DESCRIPTION	UNIT
3128BL	12"W×9½"D×13¼"H	EA



H MERANGUE® 3-TIER SORTER

Can be used on the desk or easily mounted to a wall. Scratch and chip resistant. Label holders on each shelf. Black.

ORDER NUMBER	DESCRIPTION	UNIT
1 1025-0502-00-000	Letter, 12"W×8¾"D×6⅞"H	EA
2 1025-0492-00-000	Legal, 15"W×8¾"D×6⅞"H	EA



**A MERANGUE®
METAL 6-SECTION VERTICAL SORTER**

Scratch and chip-resistant finish. Non-skid, no-scuff feet to protect surfaces. Black.

ORDER NUMBER	DESCRIPTION	UNIT
1025-0532-00-000	11¼"W×10⅞"D×7⅞"H	EA

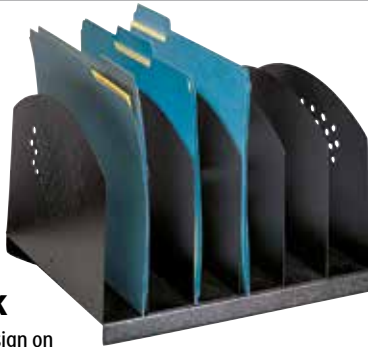

**C SAFCO®
STEEL DESK RACK**

Decorative contemporary design on front and end panels. All-steel construction with durable black powder coat finish. Rubber feet included. Six vertical sections. Greenguard certified.

ORDER NUMBER	DESCRIPTION	UNIT
3155BL	12¼"W×11¼"D×8"H	EA



**E VICTOR KORR®
EXPAND-A-FILE**

Six sections to help you organize files. Made from 75% recycled material. Greenguard certified.

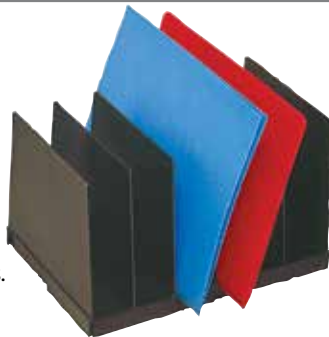

ORDER NUMBER	DESCRIPTION	UNIT
69773-60002	Black, 12"W×8½"L×8½"H	EA



**G MERANGUE®
STACKING TRAYS**

Stack multiple trays together to keep your desktop organized. Side-loading. Letter size. Black.

ORDER NUMBER	DESCRIPTION	UNIT
1025-8351-00-000	13¼"W×8¾"L×2¾"H	2/PK



**B VICTOR KORR®
SIDE LOADING STACKING TRAYS**

Stacks easily and securely. Contains a minimum of 75% recycled material.

ORDER NUMBER	DESCRIPTION	UNIT
LETTER SIZE, 13½"W×8⅞"L×2¾"H		
1 69773-16202	Black	2/PK
LEGAL SIZE, 16¼"W×9"L×2¾"H		
2 69773-27202	Black	2/PK

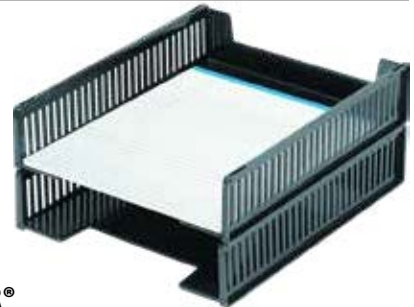

**D VICTOR KORR®
FRONT LOADING STACKING TRAYS**

Stacks easily and securely. Contains a minimum of 75% recycled material. Letter size, 10½"W×12½"L×2⅝"H.

ORDER NUMBER	DESCRIPTION	UNIT
69773-19022	Black	2/PK



**F VICTOR KORR®
DESK ACCESSORIES**

Functional design for all offices. Tray is 10.4"W×14.9"L×2.4"H. Contains a minimum of 75% post-consumer recycled material. Designed to link 2 trays together. Plastic. Black.

ORDER NUMBER	DESCRIPTION	UNIT
1 69773-12502	Front Loading Tray, Legal size	EA
2 69773-14000	Desk Tray Supports	4/ST

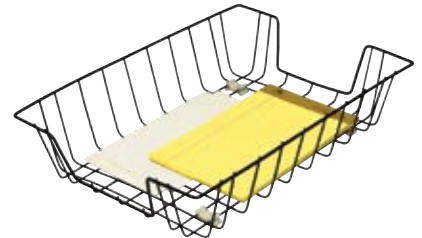

**H WESTCOTT®
WIRE DESK TRAY**

Front-loading wire desk tray has an indentation in the centre of both ends for easier access. Black.

ORDER NUMBER	DESCRIPTION	UNIT
1 65956-42012	Letter, 10"W×14"D×3"H	EA
2 65956-42015	Legal, 11"W×17"D×4"H	EA

Workspace Organization – sorters and bookends



A MERANGUE ANGLE STEP SORTER

Keep your files organized and off your desk. Angled design allows you to see all documents at once. Features five compartments. Black.

ORDER NUMBER	DESCRIPTION	UNIT
1025-8361-00-000	13¾"W×9¼"D×9¼"H.	EA



B STOREX® INCLINE SORTER

Graduated steps keep files visible and easy to reach. Six divisions hold forms, folders, mail and more. Contains 50% recycled material. Black.

ORDER NUMBER	DESCRIPTION	UNIT
70164U06C	10"W×6½"L×6¾"H	EA



C WESTCOTT® WIRE SORTER

Sleek, open-wire design for a clear view of all your work. 11 sections. Black.

ORDER NUMBER	DESCRIPTION	UNIT
65956-42016	7¼"W×11"D×7¼"H.	EA

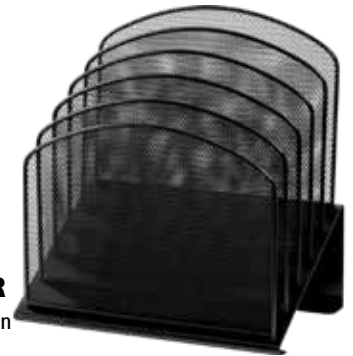

D MERANGUE® MESH LETTER HOLDER

Step sorter design makes sure you can see all the contents. 5-Slots. Black.

ORDER NUMBER	DESCRIPTION	UNIT
MIL50672-CA	17½"W×713⁄64"D×125⁄64"H	EA



E DEFLECTO® STANDING DESK ACCESSORIES

Conveniently holds your items steady and out of the way. Easily and securely clamps to side of desk, no tools needed. Adjusts to fit 3/4" to 2" flat rails. Protective cushioned pads are safe for desktop surfaces. Grey ABS.

ORDER NUMBER	DESCRIPTION	UNIT
1 400000	Cup Holder with Tray, 4"W×7"D×3½"H	EA
2 400001	Small Organizer, 3"W×3¾"D×3½"H	EA
3 400002	Large Organizer, 9"W×6¾"D×3½"H	EA
4 400003	File Organizer, 12"W×10"D×7¾"H	EA



F SAFCO® ONYX™ HANGING DESK ACCESSORIES

Wire mesh hanging organizers attach to desktop and hang to provide underdesk storage. Design performs well in sit-stand applications and other mobile work environments. Scratch-resistant powder coat finish and rolled edges. Black. Attaches to surfaces up to 1¾" thick.

ORDER NUMBER	DESCRIPTION	UNIT
4 horizontal underdesk trays.		
1 3242BL	10¼"W×12¾"D×12"H	EA
3 vertical underdesk file sections.		
2 3243BL	9½"W×12"D×1¼"H	EA



A SAFCO® STEEL WALL POCKETS

Contemporary design; for letter or legal size charts and files. Durable, mar-resistant powder coated black finish. With mounting hardware. Greenguard certified.

ORDER NUMBER	DESCRIPTION	UNIT
1 3170BL	Letter size, 12"×3"×9"	EA
2 3171BL	Legal size, 15"×3"×9"	EA
3 3172BL	Letter size, triple, 12"×3¼"×17¼"	EA

B SAFCO® 7-POCKET WALL RACK

Modern design with open sides. Durable powder coat finish. Includes wall-mounting hardware. Greenguard certified. Letter/legal size. 9½"×2"D×21¾"H.

ORDER NUMBER	UNIT
3185BL	EA



C MERANGUE® 3-TIERED MESH WALL FILE

One piece construction easily mounts to walls. Includes mounting hardware. 18½"L×13"W×3½"H. Black.

ORDER NUMBER	UNIT
MIL11990-CA	EA



D STOREX® UNBREAKABLE WALL FILES

Shatterproof polycarbonate. Contains 100% post-consumer material. Includes mounting hardware. Letter: 13"W×7"H×4"D. Legal: 16¼"×7"H×4"D



ORDER NUMBER	DESCRIPTION	UNIT
LETTER SIZE, 13"W×4"D×7"H		
1 70362U06C	Black	EA
2 70353U06C	Black	NEW! 3/PK
3 70322U06C	Clear	EA
4 70313U06C	Clear	NEW! 3/PK
LEGAL SIZE, 16¼"W×4"D×7"H		
5 70361U06C	Black	EA
6 70354B06C	Black	NEW! 3/PK
7 70321U06C	Clear	EA
8 70357U06C	Clear	NEW! 3/PK



E STOREX® WALL FILES

Contains 100% post-consumer material. Letter: 13"W×7"H×4"D. Legal: 16¼"W×7"H×4"D

ORDER NUMBER	DESCRIPTION	UNIT
1 70209B06C	Letter, Black	2/PK
2 70210B06C	Legal, Black	2/PK
3 70223B06C	Letter, Clear	2/PK
4 70224B06C	Legal, Clear	2/PK



F STOREX® MAGNETIC WALL FILE

Extra strong magnets support up to 5 lbs. of weight so there's no need for drilling or adhesives. The back wall ensures that no paper, big or small, will slip between the cracks. 16"W×4"D×7"H.

ORDER NUMBER	DESCRIPTION	UNIT
70226B06C	Legal, Black	EA



G DEFLECTO® DOCUPOCKET® VERTICAL WALL FILE

Designed to hold literature in an upright position. Letter or legal size. Includes linking pins to enable additional pockets to be added, and mounting hardware. 10¼"W×4"D×10"H. Smoke

ORDER NUMBER	DESCRIPTION	UNIT
63002	Letter / Legal	EA



A FELLOWES® PARTITION ADDITIONS™ CUBICLE ACCESSORIES

Organization products for partition walls. Clears desktop clutter and maximizes shrinking cubicle and desk space. Patented ViperPin™ technology allows Partition Additions to adhere to any tackable surface. Made from 100% post-industrial recycled plastic material; Black.

ORDER NUMBER	DESCRIPTION	UNIT
1 75270	Clip, 1¼" W×17⁄8" H×5⁄8" D	4/CD
2 75275	File pocket, 14" W×7¾" H×2½" D	EA



C WESTCOTT® PARTITION/WALL SYSTEMS

High quality wire trays or file organizers strong enough to withstand constant use. Universal bracket provides easy mounting on partitions 1½" to 3" wide. Three pockets keep files organized and within reach. Black.

ORDER NUMBER	DESCRIPTION	UNIT
1 65956-42028	Triple file organizer, letter size, 12¾" W×45⁄8" D×22¹⁄₁₆" H	EA
2 65956-42023	Triple tray, letter size, 13¼" W×10" D×18" H	EA



G SAFCO® METAL DOOR AND PANEL HOOKS

Save space and reduce clutter by using doors and privacy panels. Satin aluminum base with ball-tipped double steel chromed hooks that prevent damage to garments. Designed to slip over doors up to 1¾" thick or panels 1½" to 3¾" thick. Greenguard certified.

ORDER NUMBER	DESCRIPTION	UNIT
1 4166	Door hook, 1½" W×4¼" D×8½" H	EA
2 4167	Panel hook, 1½" W×4¼" D×8½" H	EA



B STOREX® PARTITION HANGING WALL LEGAL FILES



Partition hanger adjusts from 1½" to 3½". 100% post-consumer recycled material. Includes 3 pockets, 2 partition brackets, linking pins and mounting hardware. 16¼" W×4" D×14" to 19" H.

ORDER NUMBER	DESCRIPTION	UNIT
70316B06C	Legal, Black	3/PK

D DEFLECTO® TOP-LOADING CUBICLE SIGN HOLDER

Transparent sign holder made of durable, clear plastic is sealed on three sides. Inserts slide in from the top. Hangs on partition walls with cubicle clips, magnets, or adheres with hook and loop tape, included.



ORDER NUMBER	DESCRIPTION	UNIT
588601	8½"×11"	EA

E DEFLECTO® INTERIOR IMAGE NAMEPLATE HOLDER

Distinctive with silver and black accents. Adapts for tabletop, wall and cubicle mount applications. Anti-glare, protective sheet and mounting hardware included.



ORDER NUMBER	DESCRIPTION	UNIT
89105	8½" W×2" H	EA

F DEFLECTO® CUBICLE NAMEPLATE HOLDER

Top-loading insert; sealed on three sides to prevent literature from sliding out. Includes mounting clips, magnets and hook and loop tape.



ORDER NUMBER	DESCRIPTION	UNIT
587501	8½" W×2" H	EA

H WESTCOTT® PARTITION COAT HOOK

High quality wire construction, strong enough to withstand constant use. Universal bracket provides easy mounting on partitions and doors 1½" to 3" wide. Two hooks hold coats, umbrellas or bags. Black. 4¼" W×6¼" H×2" D.



ORDER NUMBER	DESCRIPTION	UNIT
65956-42021	Partition coat hook	EA



A DESKTEX® GLACIERMAT DESK PADS

A glass desk pad that offers an added touch of class to desk production. Crystal clear reinforced glass provides the ultimate in elegance and style. Clear.

ORDER NUMBER	DESCRIPTION	UNIT
1 FCDE1924G	19"×24"	EA
2 FCDE2036G	20"×36"	EA



C BLUELINE® DESK PAD



Perpetual calendar with one page per month. 50% post-consumer recycled paper. FSC® certified. Reinforced chipboard backer and corners.

ORDER NUMBER	DESCRIPTION	UNIT
A181722B	22"×17", Bilingual	EA



E BLUELINE® & BROWNLINE® DESK PADS/WALL CALENDARS

One month per sheet, one block per day with yearly reference calendar at bottom. Tear-off sheets, bound at top and perforated. Notes section on the side. Reinforced chipboard backer and corners. C181700 contains 50% post-consumer recycled paper. FSC® certified.

ORDER NUMBER	DESCRIPTION	UNIT
1 C181700	17¾"×10⅞", English	EA
2 C181731	21¼"×16", English	EA
3 C181731B	21¼"×16", Bilingual	EA



B DESKTEX® CLEAR DESK PADS

Features a clear finish that will not scratch or stain. Non-slip base and anti-glare. Resists copy lifting and is Phthalate free.

ORDER NUMBER	DESCRIPTION	UNIT
1 FPDE1924CV	19"×24"	EA
2 FBDE2036CV	20"×36"	EA



D DESKTEX® DESK PADS

Features a matte black finish that will not scratch or stain. Non-slip base and anti-glare. Resists copy lifting and is Phthalate free.

ORDER NUMBER	DESCRIPTION	UNIT
1 FPDE1924BV	19"×24"	EA
2 FBDE2036BV	20"×36"	EA



F CEP SILVA DESK PAD

Stylish design for a soft and elegant environment. Anti-glare transparent cover to keep a photo, a calendar or other useful notes in view. Washable on both sides. Made from phthalate-free PVC. Anti-slip soft foam base. Natural Beech.

ORDER NUMBER	DESCRIPTION	UNIT
CEP800	23"×15½"	EA

Our Brand, YOUR Savings!



A OP BRAND PAPER CLIPS

Silver colour corrugated metal. No. 1 (1¼"), 100 per box.

ORDER NUMBER	UNIT
27811-10010	BX



B ACCO® PAPER CLIPS

Choice of plain finish or corrugated anti-slip surface. Three sizes: No. 1 (1½") or No. 4 Giant (1⅞"). 100 per box.

ORDER NUMBER	DESCRIPTION	UNIT
1 50505-72380	#1 Plain	BX
2 50505-72385	#1 Corrugated	BX
3 50505-72580	#4 Plain	BX
4 50505-72585	#4 Corrugated	BX



C WESTCOTT® VINYL COATED PAPER CLIPS

Metal paper clips with a colourful vinyl coating to provide strength. Assorted colours.

ORDER NUMBER	DESCRIPTION	UNIT
1 65956-11139	1½" (28 mm)	100/BX
2 65956-90826	1¾" (33 mm)	500/PK
3 65956-11140	2" (50 mm)	100/BX
4 65956-90827	2" (50 mm)	200/PK

PAPER CLIP CHART

Use this guide to help you select the correct size paper clip. Sample paper clips shown are actual size.

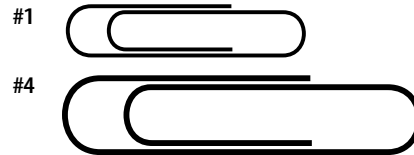

E ACCO® RECYCLED PAPER CLIPS

Contains 100% recycled material, 50% post-consumer. Available in #1 standard and #4 jumbo sizes. 100 clips per box.

ORDER NUMBER	DESCRIPTION	UNIT
1 50505-72365	Standard plain	BX
2 50505-72525	Jumbo plain	BX

D ACCO® MAGNETIC PAPER CLIP DISPENSER

Plastic with removable magnetic top. Clear and Black. 1¾"W×1¼"D×2¾"H.



ORDER NUMBER	UNIT
50505-72351	EA

F WINNABLE® MESH PAPER CLIP HOLDER

Add a clean, distinctive look to any office. Mesh enamelled wire. 3¾"W×2"H. Black.



ORDER NUMBER	UNIT
12241	EA

Our Brand, YOUR Savings!



A OP BRAND FOLDBACK CLIPS

Black or colour metal clips in convenient plastic tubs.

ORDER NUMBER	DESCRIPTION	UNIT
--------------	-------------	------

BLACK

1	27811-10013	5/16" W	100/PK
2	27811-10015	1" W	60/PK
3	27811-10014	1 1/4" W (10), and 3/4" W (50)	PK

ASSORTED COLOURS

4	27811-10016	1 1/4" W (10), and 3/4" W (50)	PK
5	27811-10018	1 1/4" W (6), 3/4" W (12), and 1/2" W (12)	PK

PASTEL COLOURS

6	27811-10017	1 1/4" W (6), 3/4" W (12), and 1/2" W (12)	PK
---	-------------	--	----



E WESTCOTT® LOOSELEAF RINGS

ORDER NUMBER	DESCRIPTION	UNIT
--------------	-------------	------

1	65956-75075	3/4"	100/BX
2	65956-75101	1"	100/BX
3	65956-75150	1"	18/PK
4	65956-75315	1 1/2"	100/BX
5	65956-75402	2"	50/BX
6	65956-75440	2"	4/PK
7	65956-75603	3"	10/BX
8	65956-75915	Asst.	15/PK



B WESTCOTT® FOLDBACK CLIPS

Strong clips for thick files, with the ability to remove the clip handles for a neat file. Flexible black metal. First dimension is the width of the clip; second is the maximum capacity; 12 per box.

ORDER NUMBER	DESCRIPTION	UNIT
--------------	-------------	------

1	65956-11210	5/16" W, capacity 1/4"	BX
2	65956-11211	3/4" W, capacity 3/8"	BX
3	65956-11212	1 1/4" W, capacity 3/8"	BX
4	65956-11213	1 3/8" W, capacity 3/8"	BX
5	65956-11214	2" W, capacity 1"	BX
6	65956-11215	1" W, capacity 1/2"	BX

CAPACITY CHART

Foldback clips

5/16"	50 sheets
3/4"	80 sheets
1"	120 sheets
1 1/4"	160 sheets
1 3/8"	200 sheets
2"	250 sheets



F WESTCOTT® MAGNETIC BULLDOG CLIPS

Shiny metallic finish bulldog style clip with a convenient magnet to attach files to metal surfaces.

ORDER NUMBER	DESCRIPTION	UNIT
--------------	-------------	------

1	65956-00060	1 1/4"	2/CD
2	65956-00061	1 1/2"	2/CD
3	65956-00064	2"	2/CD



NEW!



C OFFICEMATE® SMILING FACE BINDER CLIPS

Brighten up your desk with these colourful fun clips. 3/4". Metal. Assorted colours.

ORDER NUMBER	UNIT
--------------	------

31090	42/PK
-------	-------



D WESTCOTT® BULLDOG CLIPS

Strong metal spring clips for extra security on files. 12 per box.

ORDER NUMBER	DESCRIPTION	UNIT
--------------	-------------	------

1	65956-15107	2 3/4" W, capacity 3/4"	BX
2	65956-15125	2" W, capacity 1/4"	BX



G ACCO® IDEAL PAPER CLAMPS

No. 1, 1 3/4" x 2 3/8" or No. 2, 1 1/8" x 1 3/8". Smooth silver-colour metallic finish.

ORDER NUMBER	DESCRIPTION	UNIT
--------------	-------------	------

1	50505-72610	#1 Ideal, large	12/BX
2	50505-72620	#2 Ideal, small	50/BX



A **BLUELINE®**
DOCUMENT CORNERS

Light blue paper corners; 2"×2".

ORDER NUMBER	DESCRIPTION	UNIT
A100	Corners	100/PK



C **BRASS AND**
BRASS PLATED PAPER FASTENERS

Durable brass finish protects against corrosion. Smooth edged shank.

ORDER NUMBER	DESCRIPTION	UNIT
--------------	-------------	------

BRASS PLATED

1	50505-71709 Fasteners, ½"	100/BX
2	50505-71703 Fasteners, ¾"	100/BX
3	50505-71710 Fasteners, 1"	100/BX
4	50505-71711 Fasteners, 1¼"	100/BX
5	50505-71712 Fasteners, 1½"	100/BX
6	50505-71713 Fasteners, 2"	100/BX

ALL BRASS

7	50505-71506 Fasteners, 1½"	100/BX
8	50505-71507 Fasteners, 2"	100/BX

E **PENDAFLEX®** **FASTENERS**

Self adhesive bonded fasteners mounted on board stock with pressure sensitive backing. Board remains on fastener when placed, allowing for proper centering and alignment.



ORDER NUMBER	DESCRIPTION	UNIT
99372	2"	48/PK

F **ACCO®** **FASTENERS**

Complete fasteners, compressor and base. For use with 2-hole punched paper files.



ORDER NUMBER	DESCRIPTION	UNIT
1	50505-70012 1" capacity, 2¾" centres	50/BX
2	50505-70022 2" capacity, 2¾" centres	50/BX
3	50505-70723 3" capacity, 8½" centres	50/BX

H **ACCO®** **FASTENERS,**
BASES AND COMPRESSORS

Two-part fasteners, 2¾" centre-to-centre.



ORDER NUMBER	DESCRIPTION	UNIT
1	50505-70013 Bases, 1" capacity	100/BX
2	50505-70014 Compressors	100/BX
3	50505-70023 Bases, 2" capacity	100/BX
4	50505-70021 2" self-adhesive fasteners (use with 70014)	100/BX

Our Brand, YOUR Savings!



B **OP BRAND**
LATEX FREE
RUBBER BANDS

Natural rubber colour; 113 g (4 oz.) box.



ORDER NUMBER	DESCRIPTION	UNIT
1	27811-10029 #14, 1/16"×2"	BX
2	27811-10030 #16, 1/16"×2½"	BX
3	27811-10031 #18, 1/16"×3"	BX
4	27811-10032 #19, 1/16"×3½"	BX
5	27811-10033 #24, 1/16"×6"	BX
6	27811-10034 #32, 1/8"×3"	BX
7	27811-10035 #33, 1/8"×3½"	BX
8	27811-10036 #64, 1/4"×3½"	BX

D **MERANGUE®**
LATEX-FREE
RUBBER BANDS

Radial bands in natural rubber colour.



ORDER NUMBER	DESCRIPTION	UNIT
1	1036-0162-00-000 #10, 1/16"×1¼"	¼ LB. BX
2	1036-0182-00-000 #12, 1/16"×1¾"	¼ LB. BX
3	1036-0172-00-000 #31, 1/8"×2½"	¼ LB. BX
4	1036-0192-00-000 #107, 5/8"×7"	¼ LB. BX
5	1036-0151-00-000 #16, 1/16"×2½"	5 LB. BG
6	1036-0101-00-000 #19, 1/16"×3½"	5 LB. BG
7	1036-0111-00-000 #24, 1/16"×6"	5 LB. BG
8	1036-0121-00-000 #32, 1/8"×3"	5 LB. BG
9	1036-0131-00-000 #33, 1/8"×3½"	5 LB. BG
10	1036-0141-00-000 #64, 1/4"×3½"	5 LB. BG

G **ALLIANCE**
ANTIMICROBIAL
NON-LATEX RUBBER BANDS

Contains an antimicrobial agent that inhibits the growth of bacteria that can cause the product to deteriorate. Synthetic rubber. Cyan blue. ¼ lb. box.

ORDER NUMBER	DESCRIPTION	UNIT
1	42199 #19, 1/16"×3½"	BX
2	42249 #24, 1/16"×6"	BX
3	42339 #33, 1/8"×3½"	BX
4	42649 #64, 1/4"×3½"	BX

NEW!



I **ALLIANCE ADVANTAGE RUBBER BANDS**

Secure files, printouts, catalogues, small can liners and more. They can handle jobs ordinary rubber bands cannot. Red.

ORDER NUMBER	DESCRIPTION	UNIT
00712	#117B, 1/8"×7"	12/PK

Our Brand, YOUR Savings!



A OP BRAND INVISIBLE TAPE

For all mending applications. Becomes invisible on matte surfaces and is writable; 19 mm×32.9 m.

ORDER NUMBER	DESCRIPTION	UNIT
1 27811-10009	19.0 mm×32.9 m, Dispenser	RL
2 27811-10008	19.0 mm×32.9 m, Refill	RL



B SCOTCH® 810 MAGIC™ TAPE RECYCLED TOWER

Cheaper and uses less packaging material than individual boxed tape. Bulk package is made from 100% recycled paper.



ORDER NUMBER	DESCRIPTION	UNIT
810R-1833	19 mm×33 m	14/PK



C SCOTCH® 810 MAGIC™ TAPE

The transparent tape that becomes "invisible" when applied to paper. With a permanent adhesive that can be written on or typed over. It cannot be seen when photocopied.

ORDER NUMBER	DESCRIPTION	UNIT
--------------	-------------	------

DISPENSER PACK

- 1 810-18PP 19.0 mm×32.9 m RL
- 2 M850-6MP-ESF 19.0 mm×21.5 m 6/PK

REFILL

- 3 810-12BXD 12.7 mm×32.9 m RL
- 4 810-18BXD 19 mm×32.9 m RL
- 5 810-4PK-C 19 mm×25.4 m 4/PK
- 6 810-8PK-BXD 19 mm×25.4 m 8/PK



D SCOTCH® 600 TRANSPARENT TAPE

Clear, nearly invisible tape strong enough to be used to repair or to seal packages and envelopes, yet economical for general office use. Clear plastic dispenser with a sharp cutting edge.

ORDER NUMBER	DESCRIPTION	UNIT
--------------	-------------	------

DISPENSER PACK

- 1 600-18PP 19.0 mm×32.9 m RL
- 2 600-18PP-2PK 19.0 mm×32.9 m 2/PK

REFILL

- 3 600-12BXD 12.7 mm×32.9 m RL
- 4 600-18BXD-2PK 19 mm×32.9 m 2/PK



E SCOTCH® MAGIC™ TAPE WITH PLANT BASED ADHESIVE

The same quality as original Scotch® Magic™ matte finish markable invisible tape. Made from renewable resources, including 65% plant based adhesive. 19 mm.

ORDER NUMBER	DESCRIPTION	UNIT
1 123DM-2-EF	13.97 m dispenser	2/PK
2 812-2P-C	22.8 m, boxed	2/PK

NEW!



F HIGHLAND™ 6200 PERMANENT MENDING TAPE

Invisible, economical tape with a permanent adhesive.

ORDER NUMBER	DESCRIPTION	UNIT
6200-18BXD	19 mm×32.9 m	RL



G SCOTCH® WALL-SAFE TAPE

Tape sticks securely but removes cleanly from walls and other home and office surfaces. 19 mm.

ORDER NUMBER	DESCRIPTION	UNIT
1 183-ESF	16.5 m dispenser	RL
2 813S2	20.3 m boxed	2/PK



H SCOTCH® SUPER-HOLD TAPE

Strong and durable with 50% more adhesive so your items will hold securely. 19 mm in dispenser.

ORDER NUMBER	DESCRIPTION	UNIT
1 198-ESF	16.5 m	RL
2 198DM-2-ESF	15.5 m	2/PK

Check online for the most current price.



A SCOTCH® 845 TRANSPARENT BOOK TAPE

Polypropylene transparent tape for repairing, reinforcing or protecting book covers. Also for hinging and laminating. Will not dry out or crack. May be marked on with most permanent solvent based markers.

ORDER NUMBER	DESCRIPTION	UNIT
1 845-150	38.1 mm×13.7 m	RL
2 845-200	50.8 mm×13.7 m	RL
3 845-300	76.2 mm×13.7 m	RL
4 845-400	101.6 mm×13.7 m	RL



B SCOTCH® DOUBLE SIDED TAPE

Convenient tape with double stick feature.

ORDER NUMBER	DESCRIPTION	UNIT
136NA	12.7 mm×6.3 m	RL



C SCOTCH® REMOVABLE POSTER TAPE

Sticky on both sides. Securely mounts posters and light objects. Removes easily with no mess or damage.

ORDER NUMBER	DESCRIPTION	UNIT
109S-ESF	19 mm×3.81 m	RL



D WESTCOTT® DESKTOP TAPE DISPENSER

Plastic body with weighted base to hold dispenser on desk while using with one hand. Accepts tapes up to 18 mm×33 m.

ORDER NUMBER	DESCRIPTION	UNIT
65956-80015	Black	EA



E WESTCOTT® SLANT LINE TAPE DISPENSER

Moulded, chip-proof, high-impact plastic with a metal cutting edge. Dispenser accommodates tapes up to 19 mm×33 m.

ORDER NUMBER	DESCRIPTION	UNIT
65956-80038	Black	EA



F WESTCOTT® REFILLABLE TAPE DISPENSER

Metal cutting blade. 1" (24 mm) core. Maximum refill size is 19 mm×33 m. Refill not included.

ORDER NUMBER	DESCRIPTION	UNIT
65956-80127	Smoke	EA



G SCOTCH® C-20 WAVE DESKTOP TAPE DISPENSERS

Personalize your desk with style. This sleek and modern dispenser fits with today's home décor. Weighted for easy tape dispensing and can handle rolls up to 38.1 m.

ORDER NUMBER	DESCRIPTION	UNIT
1 C20-WAVE-MB	Metallic Bronze	EA
2 C20-WAVE-MI	Molten Ink	EA



H SCOTCH® C-60 TAPE DISPENSER

Attached spindle to hold tape firmly in place.

ORDER NUMBER	DESCRIPTION	UNIT
1 C60-BK	Black	EA
2 C60-ST	Silver/Black	EA



I SCOTCH® C47 HEDGEHOG DESKTOP TAPE DISPENSER

The weighted base allows for one-handed dispensing. Holds rolls up to 19 mm×38.1 m. Includes one roll of Scotch® Magic™ tape. White and gold.

ORDER NUMBER	UNIT
C47-HEDGEHOG-G	EA

Adhesives – mounting supplies



A COMMAND™ ADHESIVE GENERAL PURPOSE HOOKS

Holds firmly and removes cleanly with no surface damage to paint or walls.

ORDER NUMBER	DESCRIPTION	HOLD (lbs)	UNIT
1	17004C Jumbo hook, White	7.5	1/PK
2	17003C Large hook, White	5	1/PK
3	17003C-VP Large hook value pack, White	5	3/PK
4	17019-EF Clothes hanger, White	7.5	1/PK
5	17001C Medium hooks, White	3	2/PK
6	17001EF-VP Medium hooks value pack, White	3	6/PK
7	17001-MPEF Medium hooks mega pack, White	3	20/PK

ORDER NUMBER	DESCRIPTION	HOLD (lbs)	UNIT
8	17091CLR-VP Medium hooks value pack, Clear	2	6/PK
9	17068C Medium wire hooks, White	3	2/PK
10	17067CLR-C Small wire hooks, Clear	0.5	3/PK
11	17067-MPEF Small wire hooks mega pack, White	0.5	28/PK
12	17006CLR-C Mini hooks, Clear	0.5	6/PK
13	17200C Replacement strips 8 small, 4 medium, 4 large		16/PK



B COMMAND™ ADHESIVE DECORATIVE HOOKS

Holds firmly and removes cleanly with no surface damage to paint or walls.

ORDER NUMBER	DESCRIPTION	HOLD (lbs)	UNIT
1	17053BN-C Large faux metal hook, Brushed Nickel	5	1/PK
2	17063BN-C Large timeless hook, Brushed Nickel	5	1/PK
3	17036MB-EF Large double hook, Matte Black	5	1/PK
4	17051BNC-VP Medium faux metal hooks value pack, Brushed Nickel	3	3/PK
5	17026CLR-C Decorating hook, Clear	0.5	20/PK

C COMMAND™ ADHESIVE DESIGNER HOOKS

Holds firmly and removes cleanly with no surface damage to paint or walls. White.

ORDER NUMBER	DESCRIPTION	HOLD (lbs)	UNIT
1	17083-EF Large hook	5	1/PK
2	17081-EF Medium hooks	3	2/PK
3	17082-EF Small hooks	1	2/PK

Adhesives – mounting supplies



A COMMAND™ PICTURE HANGING KIT

No more nail holes, cracked plaster or sticky residue. Includes 3 sawtooth hangers, 2 wire-backed hangers, 5 large strips, 4 large, 8 small picture hanging strips and 16 poster strips.



ORDER NUMBER	DESCRIPTION	UNIT
17213-EF	White	PK



B COMMAND™ ADHESIVE PICTURE HANGING STRIPS

ORDER NUMBER	DESCRIPTION	HOLD (lbs)	UNIT
1	17206BLK-C Large picture hanging strips, Black	4	4/PK
2	17206BLK-12EF Large picture hanging strips, Black	4	12/PK
3	17206-12EF Large picture hanging strips, White	4	12/PK
4	17201C Medium picture hanging strips, White	3	3/PK
5	17204-12EF Medium picture hanging strips value pack, White	3	12/PK
6	17201BLK-C Medium picture hanging strips, Black	3	4/PK
7	172024C Poster strips	1	12/PK

C 3M CLAW™ DRYWALL PICTURE HANGERS

Engineered hardened steel claws lock into drywall anywhere. No tools required, just push in with your thumb. Includes a spot marker to mark exactly the right spot on your wall.



ORDER NO.	DESCRIPTION	UNIT
3PH15M-5EF	Holds up to 15 lbs, 5 sets/pkg	PK
3PH25M-4EF	Holds up to 25 lbs, 4 sets/pkg	PK
3PH45M-3EF	Holds up to 45 lbs, 3 sets/pkg	PK

D SCOTCH™ INDOOR FASTENERS

Convenient way to mount objects in home, office, or car. Ideal for mounting remotes, keeping floor rugs from slipping and seat cushions in place. Lasts for thousands of closures. Fastens to painted, varnished drywall, wood, metal, glass, plastic or brick surfaces.



ORDER NUMBER	DESCRIPTION	UNIT
1	RF4711 ¾"×18", Black	PK
2	RF4740 ¾"×5", White	PK

E VELCRO® FASTENERS

Self-adhesive white hook and loop fasteners.



ORDER NUMBER	DESCRIPTION	UNIT
1	90070 ¾" circles, 15 sets per pack	PK
2	90073 7/8" squares, 12 sets per pack	PK
3	90076 ¾"×3½" strips, 4 sets per pack	PK
4	90082 ¾"×15' tape	EA

F SCOTCH™ EXTREME FASTENERS

Functional indoors and outdoors for holding down tarps, hanging metal signs, mounting tools or solar lights, hanging chalkboards and framed art. Lasts for 1000 closures.



ORDER NUMBER	DESCRIPTION	UNIT
1	RF6731 1"×3", Black	PK
2	RF6740 1"×4", Clear	PK

G VELCRO® INDUSTRIAL STRIPS AND STRAPS

Reusable Velcro Brand® hook and loop cable ties. Keep workstations tidy and safely store extra cabling. Contains a minimum of 40% post-consumer recycled material. Black.

ORDER NUMBER	DESCRIPTION	UNIT
1	VEL-30189-CAN Precut strips, 3"×1¾"	2/PK
2	VEL-30187-CAN Straps, 10"×1"	6/PK



A LEPAGE® NO MORE NAILS MOUNTING TAPE

Super strong, holds up to 50 kg per roll. Translucent, double-sided; mounts to many surfaces including wood, metal, glass, concrete and certain plastics.

ORDER NUMBER	UNIT
61083-63897	EA



B SCOTCH-MOUNT® DOUBLE SIDED MOUNTING TAPE

Easy-to-apply design with no mess or tools. Features 3M™ Industrial Strength Adhesive. Choose the right tape for the job.



ORDER NUMBER	DESCRIPTION	UNIT
1 110H-DC-EF	Indoor for Painted Surfaces, 15 lb. ½"×80"	EA
2 410H-DC-EF	Clear for Invisible Hold, 15 lb. 1"×60"	EA
3 414H-DC-EF	Indoor/Outdoor Extreme Hold, 30 lb. 1"×60"	EA

C SCOTCH® RESTICKABLE MOUNTING TABS

Clear tabs are invisible on windows, mirrors and thin paper. Reusable – mount your favourite projects, photos and more over and over again with the same strip.

ORDER NO.	DESCRIPTION	UNIT
R1005-ES	1"×1"	18/PK



D LEPAGE® FUNTAK®

Adhesive putty that won't dry out; non-toxic, non-flammable and repositionable. Mount posters or photographs without using pins. 56g.

ORDER NUMBER	DESCRIPTION	UNIT
61083-05401	56 g	CD



E 3M™ SUPER 77 SPRAY ADHESIVE

Permanently bonds almost any material. Aerosol spray.

ORDER NUMBER	DESCRIPTION	UNIT
77-240Z	467 g.	EA



NEW!

F ELMER'S® TAC 'N STIK® ADHESIVE PUTTY

Removable adhesive putty that replaces tapes and tacks. Ideal for holding posters, messages, displaying decorations on windows and more. Reusable and won't dry out. Non-toxic and acid-free. 84 g.

ORDER NUMBER	UNIT
61550-06531	PK



G 3M™ HANG TABS

Sticks instantly to shrink-wrapped packages, cartons and product surfaces. Clear tape lets packaging copy show through.

ORDER NUMBER	DESCRIPTION	UNIT
1 1075-2X2	Delta Hole	10/PK
2 1076-2X2	Round Hole	10/PK



H SCOTCH® REPOSITIONABLE GLUE STICK

Allows you to adjust and move bonded items after application. Soap and water clean up. Dries clear and wrinkle-free. Non-toxic and acid free.

ORDER NUMBER	UNIT
6307C	EA



NEW!



A UHU® GLUE ROLLER

Innovative glue tape with Smart Dot technology for a fast, clean and precise application. Permanent. Non-refillable. 6.5 mm×9.5 m.

ORDER NUMBER	UNIT
9U50465	EA



D LEPAGE® PRITT™ ADHESIVE ROLLER

Dispenser makes application quick, precise and clean. Applies evenly without smearing. Permanent. 8.4 mm×10 m.

ORDER NUMBER	UNIT
61083-63990	EA



G STANLEY® GLUE GUNS

Trigger feed glue gun uses hot melt or dual-temperature glue sticks. Heats up quickly and bonds within 60 seconds.

ORDER NUMBER	DESCRIPTION	UNIT
MINI GLUESHOT™		
1 GR10	Glue gun	EA
2 GS10DT	4 Glue sticks	24/PK
HEAVY DUTY		
3 GR20	Glue gun	EA
4 GS20DT	4 Glue sticks	24/PK

B ELMER'S® GLUE-ALL®

For all-purpose materials including paper, cloth and wood. White.

ORDER NUMBER	DESCRIPTION	UNIT
1 60355W8	120 ml	EA
2 60359Q	225 ml	EA



E ELMER'S® WASHABLE SCHOOL GLUE

All-purpose glue for paper and other material. Non-toxic; dries clear.

ORDER NUMBER	DESCRIPTION	UNIT
1 60308Q	White, 120 ml	EA
2 60310Q	White, 225 ml	EA
3 61550-60341	White, 3.8 L	EA
4 60305Q	Clear, 147 ml	EA
5 2048351	Clear, 3.78L	EA

H GOO GONE® ORIGINAL CLEANER

Can be used on hard surfaces, carpeting, upholstery, clothing and more. Easily removes grease, gum, stickers, crayon, tape and more without harming precious surfaces. Fast-acting. No sticky residue. 236 mL.

ORDER NUMBER	UNIT
WM77112	EA



NEW!

C UHU® GLUE PEN

Convenient applicator for an easy, smooth application. Glues fast, clean and without wrinkling paper. Washable, non-toxic and solvent free. 50 mL.

ORDER NUMBER	UNIT
9U50148	EA



F TOMBOW GLUE

The Aqua is a clear liquid with a pen tip and a broad tip. The Mono also has two tips and is permanent when applied wet yet removable by letting the glue dry before positioning. Acid free and photo safe.

ORDER NUMBER	DESCRIPTION	UNIT
1 62181	Aqua Liquid Glue	EA
2 62191	Mono Multi Glue	EA

I ELMER'S® RUBBER CEMENT

Acid-free, low tack, no-wrinkle rubber cement. With a brush applicator built into the lid; 120 ml bottle.

ORDER NUMBER	UNIT
60818	EA



A LEPAGE® SUPER GLUE

Ultimate speed and strength, sets in 5 seconds. Heat and water resistant. Permanent.

ORDER NUMBER	DESCRIPTION	UNIT
2600201	20 ml	EA



NEW!

C ELMER'S® GLUE STICKS

All-purpose and photo safe. Non-toxic, acid-free. Permanent.

ORDER NUMBER	DESCRIPTION	UNIT
61550-60556	8 g	30/BX



E UHU® STIC

Acid-free, non-toxic, washable glue in a stick. Glides smoothly, lasts a long time.

ORDER NUMBER	DESCRIPTION	UNIT
1 9U99648	8.2 g	EA
2 9U99649	21 g Jumbo	EA
3 9U99655	40 g Giant	EA



F LEPAGE® ULTRA GEL LEPAGE® GLUE STICK

Non-toxic. Quick bonding, acid-free and safe for photos. Features airtight snap-lock cap.

ORDER NUMBER	DESCRIPTION	UNIT
1 61083-00533	10 g	EA
2 61083-00534	20 g	EA
3 61083-00535	40 g	EA



NEW!

H UHU® STIC COLOUR GLUE STICK

Colour goes on blue but dries clear. Makes it easier to see exactly where the glue is being placed.

ORDER NUMBER	DESCRIPTION	UNIT
1 9U99602	21g	EA
2 9U99653	40 g	EA



OP Our Savings Brand!

B OP BRAND GLUE STICKS

Positive seal cap prevents dry-out; harder formulation spreads evenly. For paper, cardboard, fabric, photos, etc.

ORDER NUMBER	DESCRIPTION	UNIT
1 27811-10004	20 g	EA
2 27811-10005	40 g	EA

D INSTANT KRAZY® GLUE

Ideal for every-day household repairs of wood, glass, metal, plastic and ceramic.

ORDER NUMBER	DESCRIPTION	UNIT
1 61550-10100	1.9ml Tube	EA
2 61550-10582	Single use tubes	4/CD



G KRAZY® GLUE ADVANCED PRECISION PEN

Push-n-glue precision applicator. Ideal for plastics, ceramics, and rubber.

ORDER NUMBER	DESCRIPTION	UNIT
10340Q	4 ml	EA



I LEPAGE® SUPER MINI TRIO GLUE

For consumers accustomed to using tubed super glue. Great for wood, rubber, leather, ceramic, paper and plastic. Permanent.

ORDER NUMBER	UNIT
1837608	3/PK





Bringing colour together.

Colours and ideas are brighter together. This year, we worked with the Pantone Color Institute to refresh the Post-it® Notes you love. And now, with even more colours to choose from, your ideas can be brighter than ever.

Notes and Flags – self-adhesive notes



A POST-IT® SUPER STICKY CANARY YELLOW NOTES

Extra-strong adhesive makes sure your notes stick to those vertical surfaces!

ORDER NUMBER	DESCRIPTION	SHEETS/PAD	UNIT
1 622-10SSCY	2"×2"	90	10/PK
2 654-12SSCY	3"×3"	90	12/PK
3 655-SSCY-C	3"×5"	90	EA
4 675-3SSCY-C	4"×4", lined	90	3/PK
5 660-3SSCY	4"×6", lined	90	3/PK

NEW!



B POST-IT® SUPER STICKY NOTES

Perfect mix of energizing and soothing colours to complement today's work-anywhere environment.



ORDER NUMBER	DESCRIPTION	SHEETS/PAD	UNIT
1 654-5SSJOY	3"×3"	90	5/PK
2 654-12SSJOY	3"×3"	90	12/PK
3 660-3SSJOY	4"×6", lined	90	5/PK



C POST-IT® SUPER STICKY NOTES

Revolutionary adhesive technology ensures notes stick securely to more surfaces. Energy Boost colours.



ORDER NUMBER	DESCRIPTION	SHEETS/PAD	UNIT
1 622-8SSAU	2"×2"	90	8/PK
2 654-5SSUC	3"×3"	90	5/PK
3 675-3SSUC-C	4"×4", lined	90	3/PK
4 660-3SSUC	4"×6", lined	90	3/PK
5 660-24SSAU-CP	4"×6", lined	90	24/PK

NEW!



D POST-IT® SUPER STICKY NOTES MINI BOX

Comes in convenient storage box with reclosable lid that can also tear-off for easy access. 3"×3". 45 sheets per pad. Assorted Bright colours.

ORDER NUMBER	DESCRIPTION	SHEETS/PAD	UNIT
654-15SSCP	3"×3"	45	15/PK

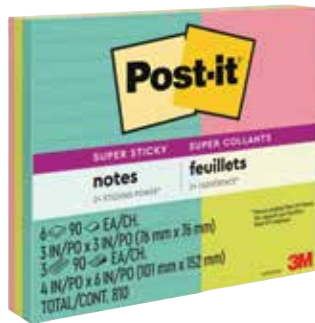

E POST-IT® SUPER STICKY NOTES COMBO PACKS

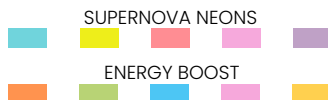

ORDER NUMBER	DESCRIPTION	SHEETS/PAD	UNIT
EACH PACK INCLUDES ONE 3"×2", ONE 3"×3", & ONE 3"×4" PAD			
1 3432-SSMIA	Supernova colours	45	3/PK
2 3432-SSAU	Energy Boost colours	45	3/PK
EACH PACK INCLUDES THREE 4"×6" LINED, & SIX 3"×3" PADS			
3 4633-9SSMIA	Supernova colours	90	9/PK
4 4633-9SSAU	Energy Boost colours	90	9/PK



F POST-IT® SUPER STICKY FULL STICK NOTES

Full adhesion across the entire back of each note ensures the whole pad stays together when stuck to a surface. Notes hold securely to the inside of planners, ring binders, calendars and journals. 25 sheets per pad. Energy Boost colours.

ORDER NUMBER	DESCRIPTION	UNIT
1 F220-8SSAU-C	2"×2"	8/PK
2 F330-4SSAU	3"×3"	4/PK
3 F330-12SSAU-C	3"×3"	12/PK

Check online for the most current price.

Notes and Flags – self-adhesive notes



A POST-IT® RECYCLED SUPER STICKY NOTES

Brightly coloured Super Sticky Notes. Contains a minimum of 30% post-consumer recycled material. Assorted colours. Oasis colours.



ORDER NUMBER	DESCRIPTION	SHEETS/PAD	UNIT
1 654-5SST	3"×3"	90	5/PK
2 675-3SST-C	4"×4", lined	90	3/PK
3 660-3SST	4"×6", lined	90	3/PK



C POST-IT® SUPER STICKY NOTES

Fun and vibrant colours help to draw attention. Assorted Supernova Neon colours.



ORDER NUMBER	DESCRIPTION	SHEETS/PAD	UNIT
1 3321-SSMIA	3"×3"	45	3/PK
2 622-8SSMIA	2"×2"	90	8/PK
3 654-5SSMIA	3"×3"	90	5/PK
4 654-24SSMIA-CP	3"×3"	70	24/PK
5 675-3SSMIA	4"×4", lined	90	3/PK
6 660-3SSMIA	4"×6", lined	90	3/PK
7 660-24SSMIA-CP	4"×6", lined	90	24/PK

NEW!



E POST-IT® SUPER STICKY BIG NOTES

These notes encourage you to think & dream big.

ORDER NUMBER	DESCRIPTION	SHEETS/PAD	UNIT
BN11	11"×11", Bright Yellow	30	EA



B POST-IT® SUPER STICKY MEETING NOTES

Large sheets in bright colours keep meeting creativity flowing. Assorted colours. Energy Boost colours.



ORDER NUMBER	DESCRIPTION	UNIT
1 6445-SSP	6"×4"	8/PK
2 5845-SS	5"×8", lined	2/PK
3 6845-SSPL	8"×6", lined	4/PK



D POST-IT® 100% RECYCLED SUPER STICKY NOTES

Contains 100% post-consumer recycled material.



ORDER NUMBER	DESCRIPTION	SHEETS/PAD	UNIT
1 654R-5SSNRP	3"×3", Wonderlust	70	5/PK
2 675R-3SSNRP	4"×4", Lined, Wonderlust	70	3/PK
3 4621R-4SSNRP	4"×6", Lined, Wonderlust	70	4/PK
4 654R-5SST	3"×3", Oasis	70	5/PK
5 675R-3SST	4"×4", Lined, Oasis	70	3/PK
6 4621R-4SST	4"×6", Lined, Oasis	70	4/PK
7 654R-12SSCY	3"×3", Canary Yellow	70	12/PK



F POST-IT® SUPER STICKY NOTES CUBE

Multiple bright colours makes sure your messages stand out. Made with plant-based adhesive. Assorted Bright colours.

ORDER NUMBER	DESCRIPTION	SHEETS/PAD	UNIT
1 2027-SSGFA	3"×3"	360	EA
2 2027-SSAFG-EF	3"×3"	360	EA

Notes and Flags – self-adhesive notes



A POST-IT® NOTES

Colours that light up any message; 100 sheets /pad. Assorted Poptimistic colours.

POPTIMISTIC

ORDER NUMBER	DESCRIPTION	UNIT
1 653AN	1½"×2"	12/PK
2 654-5PK	3"×3"	5/PK
3 655-5PK	3"×5"	5/PK
4 675-5LAN	4"×4"	5/PK
5 630-6AN	3"×3", lined	6/PK
6 635-5AN	3"×5", lined	5/PK
7 660-3AN	4"×6", lined	3/PK



B POST-IT® NOTES

A mix of colours in every package. Plain paper or lined. Assorted Floral Fantasy colours

FLORAL FANTASY

ORDER NUMBER	DESCRIPTION	SHEETS/PAD	UNIT
1 653-AU	1½"×2"	100	12/PK
2 654-5UC	3"×3"	100	5/PK
3 654-14AU	3"×3"	100	14/PK
4 655-5UC	3"×5"	100	5/PK
5 635-5AU	3"×5", lined	100	5/PK
6 660-3AU	4"×6", lined	100	3/PK
7 675-3AUL	4"×4", lined	200	3/PK



C POST-IT® GREENER NOTES

Made from 100% recycled paper with 30% post-consumer content. Plant based renewable adhesive.

SWEET SPRINKLES

ORDER NUMBER	DESCRIPTION	UNIT
1 653-RP	1½"×1½", Yellow	12/PK
2 653-RP-A	1½"×1½", Sweet Sprinkles	12/PK
3 654-RP	3"×3", Yellow	12/PK
4 654-RP-A	3"×3", Sweet Sprinkles	12/PK
5 655-RP	3"×5", Yellow	12/PK
6 655-RP-A	3"×5", Sweet Sprinkles	5/PK
7 660-RP-A	4"×6" lined, Sweet Sprinkles	5/PK
8 654R-24CP-CY	3"×3" cabinet pack, Yellow	24/PK
9 654R-24CP-AP	3"×3" cabinet pack, Sweet Sprinkles	24/PK



D POST-IT® DIE CUT NOTES

Colourful shapes that get noticed.

ORDER NUMBER	DESCRIPTION	SHEETS/PAD	UNIT
1 7350-APL	Apple	75	2/PK
2 7350-HRT	Heart	75	2/PK
3 7350-STR	Star	75	2/PK
4 7350-BLB	Thought bubble	75	2/PK



E POST-IT® SUPER STICKY NOTES

Designed to facilitate project management. Great for collaboration sessions. 90* sheets/pad. Colours: *SC Black, RR Candy Red, Y Electric Yellow, BE Electric Blue, LE Limeade, W White, NP Neon Pink, NO Neon Orange. *SC Black has only 70 sheets per pad.

ORDER NUMBER	DESCRIPTION	UNIT
654-5SS__	3"×3", Specify colour	5/PK



F POST-IT® NOTE CUBES

Rich, coloured Post-it® notes in a convenient cube.

ORDER NUMBER	DESCRIPTION	SHEETS/CUBE	UNIT
1 2051-PAS	Pastel, 2"×2"	400	EA
2 2051-BRT	Bright, 2"×2"	400	EA
3 2051-3PK	Assorted Bright, 2"×2"	400	3/PK
4 2027-PAS	Pastel, 3"×3"	490	EA

OFFICE SUPPLIES

Check online for the most current price.

Notes and Flags – self-adhesive notes



A POST-IT® RECYCLED NOTES

Notes and packaging box are made from 100% recycled post-consumer material. Yellow or assorted pastel rainbow colours. 100 sheets per pad.

ORDER NUMBER	DESCRIPTION	UNIT
1 655-1T	Yellow, 3"×5"	16/PK
2 655-1RPT	Pastels, 3"×5"	16/PK



C POST-IT® NOTES IN CANARY YELLOW

The original yellow repositionable note.

**BUY MORE
SAVE MORE**

ORDER NUMBER	DESCRIPTION	SHEETS/PAD	UNIT	1-11	12
PLAIN POST-IT® NOTES					
1 653	1½"×2"	100	12/PK		
2 654	3"×3"	100	EA		
3 655YEL	3"×5"	100	12/PK		
4 659	4"×6"	100	EA		
LINED POST-IT® NOTES					
5 630-6PK	3"×3"	100	6/PK		
6 635	3"×5"	100	12/PK		
7 675YL	4"×4"	300	EA		
8 660	4"×6"	100	EA		



B HIGHLAND™ NOTES

100 sheets per pad, yellow or assorted colours.

ORDER NUMBER	DESCRIPTION	UNIT
1 6539-36	Yellow, 1½"×2"	12/PK
2 6549Y	Yellow, 3"×3"	12/PK
3 6559	Yellow, 3"×5"	12/PK
4 6609	Yellow, 4"×6", Lined	12/PK



D POST-IT® CABINET PACKS

Value pack of 24 Post-it® note pads in a convenient storage box.

ORDER NUMBER	DESCRIPTION	SHEETS/PAD	UNIT
1 653-24APVAD	Beachside, 1½"×1½"	90	24/PK
2 654-24CP	Yellow, 3"×3"	100	24/PK
3 654R-24CP-CY	Yellow Greener Notes, 3"×3"	100	24/PK
4 660-24SSMIA-CP	Supernova Neon Super Sticky, 4"×6"	90	24/PK
5 660-24SSAU-CP	Energy Boost Super Sticky, 4"×6"	90	24/PK

NEW!
NEW!
NEW!
NEW!

Notes and Flags – pop-up notes and dispensers



A POST-IT® SUPER STICKY POP-UP NOTES

For use in pop-up dispensers. 90 sheets/pad.

ORDER NUMBER	DESCRIPTION	UNIT
--------------	-------------	------

3"×3"

1	R330-6SSMIA Supernova colours	6/PK
2	R330-6SSUC Energy Boost colours	6/PK
3	R330-6SSCY-C Canary Yellow™	6/PK
4	R330-10SSNRP Wanderlust Pastel colours	10/PK
5	R330-18SSMIACP Supernova colours cabinet pk	18/PK
6	R330-18SSAN-CP Playful Primaries NEW!	18/PK
7	R330-18SSCY-CP Canary Yellow™ NEW!	18/PK

4"×4" LINED

8	R440-WASS Aqua Wave	5/PK
9	R440-NPSS Neon Pink	5/PK



B POST-IT® POP-UP NOTES

3"×3" size notes. 100 sheets/pad.

ORDER NUMBER	DESCRIPTION	UNIT
1	R330-6AU-12-C Floral Fantasy colours	6/PK
2	R330-AN Poptimistic colours	6/PK
3	R330-6YL-C Canary Yellow™, lined	6/PK
4	R330-6YW-CA Canary Yellow™	6/PK
5	R330-24VAD-C Canary Yellow™	24/PK



C POST-IT® POP-UP WAVE NOTE DISPENSER

Contemporary textured sides and on trend colour. Weighted dispenser stays put for convenient, one-handed note dispensing. Includes 1 pad of 3"×3" Super Sticky notes. Molten Ink.

ORDER NUMBER	UNIT
WAVE-330-MI	EA



E POST-IT® NOTE STEEL TOP DISPENSERS

Keep Post-it® notes within reach. Convenient one-handed dispensing puts your notes at your fingertips. Holds 3"×3" notes.

ORDER NUMBER	DESCRIPTION	UNIT
1	STL-330-B Black	EA
2	STL-330-W White	EA



D POST-IT® 100% RECYCLED PAPER SUPER STICKY DISPENSER NOTES

100% recycled paperboard packaging. Contains a minimum of 100% post-consumer recycled material. 3"×3" 70 sheets/pad.

ORDER NUMBER	DESCRIPTION	UNIT
1	R330R-6SSCY Canary Yellow™	6/PK
2	R330R-6SST Assorted Oasis colours	6/PK
3	R330R-6SSNRP Assorted Wanderlust Pastel colour	6/PK

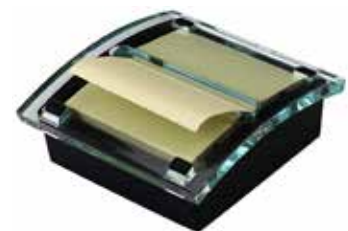

F POST-IT® POP-UP NOTE DISPENSERS

Holds 4"×4" notes.

ORDER NUMBER	DESCRIPTION	UNIT
1	DS440 Dispenser	EA
2	DS440-SSVP-EF Value Pack Includes 3×50 sheet, pop-up note pads	PK

Check online for the most current price.

Notes and Flags – flags, tabs and page markers



A POST-IT® SOLID COLOURS FLAGS

Fifty coloured repositionable 1"×1.7" flags in a dispenser. Colours: **BB** Bright Blue, **BE** Blue, **BG** Bright Green, **BP** Bright Pink, **GN** Green, **OE** Orange, **PU** Purple, **RD** Red, **WE** White, **YW** Yellow.

ORDER NUMBER	DESCRIPTION	UNIT
680-__2	Specify colour	2/PK



B POST-IT® FLAG VALUE PACKS

Assorted colours.

ORDER NUMBER	DESCRIPTION	UNIT
1 683-VAD1	280, 1/2" Flags + Bonus 48, 1/2" Arrows	PK
2 680-RYBGVA-B	200, 1" Flags + Bonus 50	PK



C POST-IT® DESK GRIP FLAG DISPENSER

Dispenser magically "sticks" to your desk without adhesive. Contains 200, 1" flags.

ORDER NUMBER	DESCRIPTION	UNIT
1 680-HVBE	Blue	EA
2 680-HVRD	Red	EA
3 680-HVYW	Yellow	EA



D POST-IT® FLAGS

Mark or highlight a page; easy to remove or reposition. Clear portable dispenser; 1" flags, 20 per pad, 3 pads per pack, assorted colours.

ORDER NUMBER	DESCRIPTION	UNIT
1 680-PBG-B	Purple, Bright blue, Bright green	PK
2 680-OLP	Orange, Lime, Pink	PK
3 680-EG-ALT-C	Electric Glow	PK



E POST-IT® MESSAGE FLAGS

Fifty repositionable 1"×1.7" flags in a practical dispenser.

ORDER NUMBER	DESCRIPTION	UNIT
1 680-31	"Sign Here", Symbol	EA
2 680-9	"Sign Here", Text	EA
3 680-IH2	"Initial Here"	2/PK
4 680-SD2	"Sign & Date"	2/PK



F POST-IT® FLAGS "SIGN HERE" VALUE PACK

Value pack comes with 2 bonus arrow flag dispensers, 48 arrow flags. 1"×1.7". 50 flags per dispenser. Assorted Colours. 4 dispensers/pk.

ORDER NUMBER	DESCRIPTION	UNIT
680-SH4VA	Value pack	PK

Notes and Flags – flags, tabs and page markers



A POST-IT® MINI FLAGS

½" wide flags in a dispenser.

ORDER NUMBER	DESCRIPTION	UNIT
1 683-4	Regular colours, 4×35 flags	PK
2 683-4AB	Bright colours, 4×35 flags	PK
3 684-ARR3	Regular colours arrows, 4×24 flags	PK
4 684-ARR4	Bright colours arrows, 4×24 flags	PK



C POST-IT® ARROW FLAGS

Five different colours, 20 flags each per package. Easily removed when required.

ORDER NUMBER	DESCRIPTION	UNIT
1 684-ARR1	Regular colours, ½"	PK
2 684-ARR2	Bright colours, ½"	PK

B POST-IT® "SIGN HERE" MINI FLAGS

½" wide flags in a dispenser.

ORDER NUMBER	DESCRIPTION	UNIT
1 684-RDSH	Red Arrows, 4×20 flags	PK
2 684-SH	Assorted Arrows, 4×30 flags	PK



D POST-IT® NOTES AND PAGE MARKERS COMBO PACK

Mark pages in books and reference materials. Removable adhesive will not damage your documents. Includes one 3"×4" pad, three 1"×3" page markers and five ½"×2" page markers. 50 sheets/pad. Assorted colours.

ORDER NUMBER	UNIT
670-COMBO	PK



E POST-IT® DURABLE INDEX TABS

Durable tabs make it easy to quickly organize binders, notebooks, planners and more! Easy to write on and simple to remove and reposition.

ORDER NUMBER	DESCRIPTION	UNIT
1 676-AYPV	5/8" Aqua, Yellow, Pink, Violet	40/PK
2 686-RYB	1" Red, Yellow, Blue	66/PK
3 686-PGO	1" Pink, Green, Orange	66/PK
4 686-FLOPBT	1" Bright Foil	36/PK
5 686-COMB01-EF	Combo Pack of ½" Flags & 1" Tabs	PK



F POST-IT® PAGE MARKERS

One pad of each of five colours. ½"×2".

ORDER NUMBER	DESCRIPTION	UNIT
1 670-5AU	Ultra colours	500/PK
2 670-5AF	Fluorescent colours	250/PK

G POST-IT® FLAGS VALUE PACKS

Writable flags to jot down a note without writing on document. Slim low profile dispenser keeps flags in reach wherever you go. Stick securely and remove cleanly with no residue.

ORDER NUMBER	DESCRIPTION	UNIT
1 683-XL1	200 - ½" & 120 - 1" Flags	PK
2 683-L1	100 - ½" Flags, 100 - ½" Arrow Flags & 60 - 1" Flags	PK



H POST-IT® FLAGS

Dispense from a handy portable pack to easily highlight important information wherever you are.

ORDER NUMBER	DESCRIPTION	UNIT
1 683-5CF	½" Regular colours	100/PK
2 684-METAL	½" Metallic colours	100/PK
PASTEL GRADIENT COLOURS		
3 684-GRDNT	½"	100/PK
4 682-GRDNT	1"	60/PK

Check online for the most current price.

Reception – telephone message supplies



A BLUELINE® CARBONLESS TELEPHONE MESSAGE BOOK

Spiral bound message book with flexible cover; 4 messages per page, 400 per book using NCR paper. 11"×5¹/₁₆". Two-part.

ORDER NUMBER	DESCRIPTION	UNIT
1 A1630T	English	EA
2 A1630FT	French	EA



B HILROY® VOICEMAIL LOG BOOK

Coil bound at top. 6¹/₄"×8³/₈". White. 5 messages per page. 100 sheets/book, 11"×8¹/₂".

ORDER NUMBER	DESCRIPTION	UNIT
65800-46215	Bilingual	EA



C HILROY® TELEPHONE MESSAGE PADS

Complete with pre-printed messages to choose from. 50 sheets per pad. 3¹/₂"×5".

ORDER NUMBER	DESCRIPTION	UNIT
1 65800-46554	English	10/PK
2 65800-46574	French	10/PK



D BLUELINE® CARBONLESS TELEPHONE MESSAGE BOOK

Spiral bound message book with flexible cover, 2-part NCR paper. 400 messages per book. 11"×5¹/₁₆".

ORDER NUMBER	DESCRIPTION	UNIT
D50977	English	2/PK



E MERANGUE® MEMO SPIKE

Suitable for messages and notes, complete with safety cap.

ORDER NUMBER	DESCRIPTION	UNIT
MIL10480-CA	Black	EA



F WINNABLE® INTERNET PASSWORD LOG BOOK

Spiral bound allowing pages to lie flat. Tabbed alphabetical pages and elastic band closure. Black. Bilingual.

ORDER NUMBER	DESCRIPTION	UNIT
WPW-36-BK	5 ³ / ₄ "×4 ¹ / ₄ "	EA

G QUARTET® GREY IN/OUT BOARD

Comprehensive 11"×14" personnel board tracks in/out status and notes for up to 18 employees on ultra-durable, ultra-smooth DuraMax® magnetic porcelain surface that will not scratch, dent, stain or ghost; easy-to-clean writing surface; contemporary black aluminum frame. Includes markers and magnets.

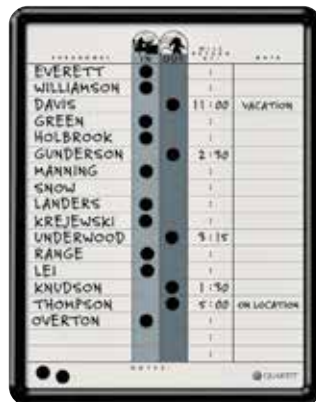

ORDER NUMBER	DESCRIPTION	UNIT
750	11"×14"	EA

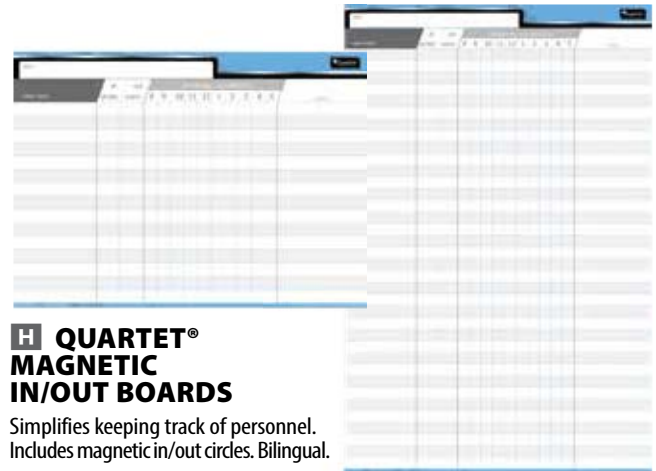

H QUARTET® MAGNETIC IN/OUT BOARDS

Simplifies keeping track of personnel. Includes magnetic in/out circles. Bilingual.

ORDER NUMBER	DESCRIPTION	UNIT
1 34138-15550	24"×36" – for up to 36 employees	EA
2 34138-15551	24"×18" – for up to 15 employees	EA

Reception – telephone / address and guest books



A BLUELINE® NOTEPRO™ TELEPHONE ADDRESS BOOK

Twin wire binding; black lizard-like hard cover; 100 indexed pages with leather-like tabs. Paper contains 50% post-consumer recycled material; FSC® certified. Trilingual. Spaces to record name, address, telephone numbers and e-mail address.

ORDER NUMBER	DESCRIPTION	UNIT
A1608C-81B	8"×5"	EA



B WINNABLE® ADDRESS BOOKS

Section sewn bound, cream coloured pages, with textured leather-like cover.

ORDER NUMBER	DESCRIPTION	UNIT
1 WA-73	6¾"×3¼", 84 pages	EA
2 WA-85	8"×5" 104 pages	EA



C AT-A-GLANCE® FASHION TELEPHONE/ADDRESS BOOKS

Concealed wire binding in an attractive hard cover. Double-letter tabs, quick reference list, ruled notes section; assorted cover designs; Bilingual.

ORDER NUMBER	DESCRIPTION	UNIT
TL771F-10	5½"×6¼"	EA



D WINNABLE® GUEST BOOK

Textured leather-like cover. Section sewn bound. Cream coloured paper, 100 pages; 7"×10".

ORDER NUMBER	DESCRIPTION	UNIT
1 WGB-03QBK	Black	EA
2 WGB-05Q-WE	White	EA



E MERANGUE® STAY PUT CLASSIC SECURITY PEN AND HOLDER

Rectangular adhesive holder fastens to any clean, flat surface; Metal chain reaches up to 24". Refillable with Merangue refill (sold separately).

ORDER NUMBER	DESCRIPTION	UNIT
1 SP628BX	Pen	EA
2 SP617BL	Pen	EA
3 38C5-4031-00-000	Pen	EA
4 3872-4121-20-000	Refill, medium Black	2/PK



F WESTCOTT® DESK BELL

Useful for service counters or reception areas. Brushed nickel finish.

ORDER NUMBER	UNIT
65956-55008	EA

Reception – business card holders



A DEFLECTO® WALL MOUNT BUSINESS CARD HOLDER

Transparent holders have pockets to display and allow clients to take cards easily.

ORDER NUMBER	DESCRIPTION	UNIT
1 79916-70601	6 pockets 8½" W×9¾" H×1⅛" D	EA



C AVERY® BUSINESS CARD HOLDERS

Protect and organize your business cards in looseleaf binders. Heavyweight construction for durability. Archival safe, won't lift ink.

ORDER NUMBER	DESCRIPTION	UNIT
77711-75353	Untabbed	5/PK



E WINNABLE® BUSINESS CARD HOLDER

Durable black mesh for a contemporary look.

ORDER NUMBER	DESCRIPTION	UNIT
12251	3¾" W×2¾" D×1¾" H	EA



B DEFLECTO® COUNTER TOP BUSINESS CARD HOLDERS

Transparent holders have pockets to display and allow clients to take cards easily.

ORDER NUMBER	DESCRIPTION	UNIT
1 79916-70801	8 pockets 7" W×5⅞" H×3½" D	EA
2 79916-70841	4 pockets, 3⅞" W×3⅞" H×4⅞" D	EA
3 79916-79999	Single, 3¾" W×1⅞" H×1⅞" D	EA

D WESTCOTT® BUSINESS CARD HOLDER

Desktop display of business cards. Size: 4" W×1¼" D×2½" H. Smoke.



ORDER NUMBER	UNIT
65956-86000	EA



F DEFLECTO® SUSTAINABLE OFFICE® BUSINESS CARD HOLDER

Contains a minimum of 60% post-consumer recycled material. 50-card capacity. 3¾" W×1⅞" D×1⅞" H. Black.



ORDER NUMBER	UNIT
79916-02506	EA

Reception – business card holders and magnifiers



A WINNABLE® BUSINESS CARD HOLDER

Black leather grain vinyl cover with stitched edging. Two inside pockets. Size: 9¾"×4½"; holds 96 cards.

ORDER NUMBER	DESCRIPTION	UNIT
NC-96	Black	EA



B WINNABLE® LOOSELEAF BUSINESS CARD FILE

Refillable 6-ring binder; transparent pockets hold three business cards per side; 120 card capacity. Index included. Black vinyl. 7½"×5½"×1¼"

ORDER NUMBER	DESCRIPTION	UNIT
1 BCH-120R	Binder	EA
2 BCH-1212	Refill	12/ST



C WINNABLE® LEATHER BUSINESS CARD HOLDER

Keeps a supply of cards ready to offer to clients. Pocket size. 20 card capacity.

ORDER NUMBER	DESCRIPTION	UNIT
BCH-100L	Black leather	EA



D GREENSIDE BUSINESS CARD POCKET

The side loading pocket is great to add to the front of a business proposal.

ORDER NUMBER	DESCRIPTION	UNIT
20106G	Side Load	10/PK



E MERANGUE® MAGNIFIERS

Classic round magnifier with 3X magnification or lighted magnifier with a bifocal, 2X and 4X, lens. Requires 2 "AA" batteries, not included.

ORDER NUMBER	DESCRIPTION	UNIT
1 LG-G75BL	Classic magnifier	EA
2 LG816BL	Lighted bifocal magnifier	EA



F MERANGUE® MAGNIFIERS

Ideal for reading small print. Heavyweight 2 mm, durable construction.

ORDER NUMBER	DESCRIPTION	UNIT
1 LG1612PG	8½"×11"	EA
2 LG828PG	7"×10"	EA
3 LG838PG	3¼"×2"	EA

Check online for the most current price.

Reception – business cards



A AVERY® INKJET AND LASER BUSINESS CARDS

Ultra-fine perforations allow easy and clean separation of cards. High-quality, heavyweight matte coated card stock. Sure Feed™ allows precision printing; prevents skewing and misfeeds of label sheets for accurate print alignment. 3½"×2".

ORDER NUMBER	DESCRIPTION	UNIT
INKJET BUSINESS CARDS		
1 67933-08371	White, 85 lbs.	250/PK
2 67933-08376	Ivory, 80 lbs.	250/PK
LASER BUSINESS CARDS		
3 67933-05371	White, 80 lbs.	250/PK
4 67933-05376	Ivory, 80 lbs.	250/PK
5 67933-05911	White, 80 lbs.	2500/BX

B AVERY® TWO-SIDED PRINTABLE CLEAN EDGE BUSINESS CARDS

Create custom business cards with no perforations. Patented design eliminates perforated edges. Cards break apart quickly and easily. Both sides coated for sharper text and vibrant colour. 3½"×2". Visit www.avery.ca for formatting templates.

ORDER NUMBER	DESCRIPTION	UNIT
FOR INKJET PRINTERS		
1 67933-38871	White, 94 lbs.	200/PK
FOR LASER PRINTERS		
2 67933-55871	White, 81 lbs.	200/PK

OFFICE SUPPLIES

C VLB® PEEL AND STICK BUSINESS CARD MAGNETS

Create lasting custom magnetic promotional cards by simply adding your preprinted cards to the magnetic base. For home or office use; 3½"×2".



ORDER NUMBER	UNIT
20583-61225	25/PK

D ROLODEX® CARD REFILLS

Add to your contacts with 2¼"×4" refill cards.

ORDER NUMBER	DESCRIPTION	UNIT
1 67558	Plain	100/PK
2 67553	Telephone/Address cards	100/PK



E WESTCOTT® BUSINESS CARD BOX

Open business card file comes with A-Z dividers. Ends fold out for ease of use.

ORDER NUMBER	DESCRIPTION	UNIT
1 65956-86400	Capacity – 400	EA
2 65956-86600	Capacity – 600	EA

F ROLODEX® ROTARY BUSINESS CARD FILE

Classic rotary file with 200 clear card sleeves (2¾"×4") to hold business cards. Includes 24 A-Z index dividers.

ORDER NUMBER	DESCRIPTION	UNIT
67236	Capacity - 400	EA





A OXFORD® WHITE INDEX CARDS

White premium quality index cards in three sizes. Blank and ruled formats.

ORDER NUMBER	DESCRIPTION	UNIT
1 30	3"×5", plain	100/PK
2 31	3"×5", ruled	100/PK
3 40	4"×6", plain	100/PK
4 41	4"×6", ruled	100/PK
5 50	5"×8", plain	100/PK
6 51	5"×8", ruled	100/PK



C OXFORD® COLOURED INDEX CARDS

Oxford® ruled index cards offer superior durability and performance. Pack of assorted colours: blue, violet, canary, green and cherry.

ORDER NUMBER	DESCRIPTION	UNIT
1 90113	3"×5"	100/PK
2 90114	4"×6"	100/PK
3 90115	5"×8"	100/PK



NEW!

E MEAD® INDEX CARDS

Sturdy and dependable. Ideal for students and professionals. Ruled.

ORDER NUMBER	DESCRIPTION	UNIT
1 43100-63350	3"×5"	100/PK
2 43100-63662	4"×6"	100/PK



B OXFORD® CARD GUIDES

Durable manila stock in three sizes and two styles: alphabetical (A-Z, 25 divisions, 1/2 cut) or blank (1/2 cut). Acid free.

ORDER NUMBER	DESCRIPTION	UNIT
1 B5325	3"×5", A-Z	ST
2 B643	4"×6", blank	100/PK
3 B8525	5"×8", A-Z	ST
4 B853	5"×8", blank	100/PK



D GREENSIDE SELF-ADHESIVE INDEX CARD FILING POCKETS

Perfect for holding recipe cards, study aids, and adding notes or labels to presentation boards. Adheres to most surfaces, repositionable on smooth, clean surfaces. Top-load. Polypropylene. Clear.

ORDER NUMBER	DESCRIPTION	UNIT
1 50150	3"×5"	50/PK
2 60150	4"×6"	50/PK
3 70150	5"×8"	50/PK



F MERANGUE INDEX CARD BOXES

Lid folds down flat to display cards. Built-in notches hold cards in position for easier access. Black.

ORDER NUMBER	DESCRIPTION	UNIT
1 1025-0610-20-000	3"×5", 250 card capacity	EA
2 1025-0600-20-000	4"×6", 300 card capacity	EA

Swingline®

747® BUSINESS STAPLERS

THE STAPLERS YOU'VE ALWAYS LOVED,
NOW WITH A NEW DESIGN AND EVEN MORE POWER

What You Have Always Loved

- Same heavy-duty metal construction
- Always deliver Jam Free, accurate stapling
- Durability guaranteed with Limited Lifetime Warranty

What's New

- Sleeker and modern design
- Direct-Impact technology (DIT) to improve stapling performance
- Stapling capacity increased to 30 sheets



©2022 ACCO Brands.
All rights reserved.
C128_22_P



Our Brand, YOUR Savings !



A OP BRAND STANDARD FULL STRIP STAPLER



Includes 1000 standard staples. Staples up to 25 sheets 20 lb. paper. Adjustable anvil; opens for tacking.

ORDER NUMBER	DESCRIPTION	UNIT
27811-10028	25 sheets	EA

B OP BRAND DELUXE STAPLER



All metal construction. Full strip. 20 sheets. Adjustable anvil. Opens for tacking. Standard staples. Includes 1,000 staples. Black.

ORDER NUMBER	DESCRIPTION	UNIT
27811-10019	20 sheets	EA



C SWINGLINE® 545® STANDARD STAPLER VALUE PACK

Smooth, contoured shape for comfortable handling. Full Strip. All metal working parts. Uses standard staples. Capacity 15 sheets. Includes staples and staple remover.

ORDER NUMBER	DESCRIPTION	UNIT
1 74711-54551	Value pack	PK
2 74711-54501A	15 sheet stapler only	EA



D SWINGLINE® 646 STANDARD FULL STRIP STAPLER

Sleek ergonomic design. All metal base and working parts. Uses standard staples. Capacity 20 sheets.

ORDER NUMBER	DESCRIPTION	UNIT
74711-64601A	20 sheets	EA



E BOSTITCH® B5000 STAPLER

Full strip stapler. Antimicrobial properties built-in (black only), No-Jam™ mechanism, full rubber base, staple supply indicator. Lifetime Limited Warranty.

ORDER NUMBER	DESCRIPTION	UNIT
1 B5000-BLACK	Black, 20 sheets	EA
2 B5000-GOLD	Gold, 20 sheets	EA



F BOSTITCH® NO-JAM™ PREMIUM STAPLER

No-Jam™ technology eliminates frustrating jams. Opens for tacking or craft use. Dual clinch system for permanent or temporary stapling. Convenient visual staple reload alert window. Staples up to 20 sheets. Uses standard SBS191/4CP staples. Black.

ORDER NUMBER	DESCRIPTION	UNIT
B660-BLACK	20 sheets	EA



G BOSTITCH® B515 ALL-METAL DESKTOP STAPLER

Full strip stapler loads 210 standard staples. All-metal design for durability. Full rubber base pad. Staple supply indicator. Lifetime Limited Warranty.

ORDER NUMBER	DESCRIPTION	UNIT
B515-BLACK	20 sheets	EA



H BOSTITCH® INPOWER™ 20 ANTIMICROBIAL DESKTOP STAPLER

Antimicrobial properties built-in. Spring powered technology allows for up to 80% easier stapling with just one finger and reduced effort. Built-in staple remover. Opens for tacking. No-Jam technology. Uses standard staples.

ORDER NUMBER	DESCRIPTION	UNIT
1100	20 sheets	EA

Staplers – full strip



NEW!

A BOSTITCH® B210 ASCEND™ STAPLER

Unique curved shape enhances stapling comfort. Equipped with a built-in remover and integrated storage compartment. All metal construction. Full strip. 20 sheets. Uses standard staples.

ORDER NUMBER	DESCRIPTION	UNIT
1 B210-BLUE-M	Metallic Blue	EA
2 B210-CHROME	Chrome	EA
3 B210-GOLD	Gold	EA
4 B210-PURPLE-M	Metallic Purple	EA



B BOSTITCH® EPIC EXECUTIVE DESKTOP STAPLER

Offers premium durability without sacrificing aesthetics. Soft rubber grip and base provide ultimate comfort. Die-cast metal construction. Stands vertically or horizontally. Antimicrobial. 25 sheets. Opens for tacking. Includes a swing out staple EZ Remover and a hidden StapleStore compartment on the bottom to keep staples handy. Uses standard staples.

ORDER NUMBER	DESCRIPTION	UNIT
1 B777-BLUE	25 sheets, Blue	EA
2 B777R-MAG	25 sheets, Magenta	EA
3 B777-RED	25 sheets, Red	EA

OFFICE
SUPPLIES



NEW!

C BOSTITCH® CLASSIC B440 STAPLER

Classic desktop design full strip stapler with all metal construction. Features staple supply indicator. Loads 210 standard staples. Black.

ORDER NUMBER	DESCRIPTION	UNIT
B440-BLACK	20 sheets	EA

NEW!



D BOSTITCH® ANTIMICROBIAL FLAT CLINCH STAPLER

Antimicrobial properties built-in to protect the product with Agion® silver ion-based agent. Stands horizontally or vertically. Fits on your desk, in your drawer, anywhere you need it. Full strip. 40 sheets. Opens for tacking. Uses standard staples. Black Chrome.

ORDER NUMBER	DESCRIPTION	UNIT
B275-BLKCH	28 sheets, Blue/Silver	EA



E BOSTITCH® DYNAMO™ STAPLER

Includes an integrated pencil sharpener and built-in staple remover. Soft ergonomic rubber grip. Full strip. 2-20 sheets. Opens for tacking. Uses standard staples. Black.



ORDER NUMBER	DESCRIPTION	UNIT
1 B696-BLK	20 sheets	EA
2 SBS191/4CP	¼" staples	5000/BX



F BOSTITCH® ANTIMICROBIAL FLAT CLINCH STAPLER

Antimicrobial properties built-in. Stands horizontally or vertically. Fits on your desk, in your drawer, anywhere you need it. Full strip. 40 sheets. Opens for tacking. Uses standard staples. Black.

ORDER NUMBER	DESCRIPTION	UNIT
B275R-BLK	40 sheets	EA



A SWINGLINE® 747® BUSINESS STAPLERS

Die-cast metal construction. Uses a full strip of standard staples. Staples up to 25 sheets of 20 lb. bond paper. Easily opens flat for tacking with base latch.

ORDER NUMBER	DESCRIPTION	UNIT
1 57074720E	25 sheets, Chrome	EA
2 74711-74736A	25 sheets, Red	EA
3 74711-74741A	25 sheets, Black	EA

C SWINGLINE® OPTIMA® 25 STAPLER

Requires half the force of regular staplers. Consistent, superior performance; 25 sheet capacity. Stylized, durable plastic housing, metal mechanism; soft grip surfaces for enhanced control. Uses SF-4 staples. Black/Charcoal.



ORDER NUMBER	DESCRIPTION	UNIT
74711-66402A	25 sheets	EA

E SWINGLINE® ULTRA ECONOMY PRO STAPLER

Durable all metal die cast construction with full non-scratching base cover for stability. Anvil rotates for stapling or pinning. Low staple indicator. Black.



ORDER NUMBER	DESCRIPTION	UNIT
74711-31002	25 sheets	EA

G SWINGLINE® 2 TO 60 SHEET DESKTOP STAPLER

Up to 30% easier to use than other heavy duty staplers. All metal. Full rubber boot maximizes desk protection. Limited lifetime warranty.



ORDER NUMBER	DESCRIPTION	UNIT
1 74711-77701	60 sheets	EA
2 74711-35550	3/8" staples	2500/BX

Our Brand, YOUR Savings!



B OP BRAND REDUCED FORCE STAPLER

Reduced force required for stapling. Front loading system for easy operation. Full strip. 40 sheets with 3/8" staples; 20 sheets with 1/4" staples. Black and White.



ORDER NUMBER	DESCRIPTION	UNIT
27811-10229	40 sheets	EA

D BOSTITCH® INPOWER™ 28 ANTIMICROBIAL PREMIUM DESKTOP STAPLERS

Antimicrobial properties built-in. Spring powered technology allows for up to 80% easier stapling. No-Jam technology. Die-cast metal construction with Integrated staple remover and staple storage compartment. Full strip. Opens for tacking. Uses standard staples.

ORDER NUMBER	DESCRIPTION	UNIT
1 1117	28 sheets, Red/Silver	EA
2 1110	28 sheets, Black/Silver	EA
3 1118	28 sheets, Blue/Silver	EA

F SWINGLINE® OPTIMA® 40 DESKTOP STAPLER

Staples up to 40 sheets at a time, requiring up to 50% less effort than traditional staplers. Quickload™ front full strip staple loading; jam free guaranteed. Compact, ergonomically advanced shape with soft grips; durable metal construction with flat clinch anvil. Uses standard, SF-4 or Optima premium staples.



ORDER NUMBER	DESCRIPTION	UNIT
1 74711-87840	40 sheets	EA
2 74711-35556	Optima™ premium staples	3750/BX

H SWINGLINE® OPTIMA® 70 STAPLER

Requires up to 50% less effort; ergonomic soft-touch handle, compact footprint. Flat clinch anvil forms the staple flat, front and back. Quickload™ front loading; jam free guaranteed. Capacity: 70 sheets.



ORDER NUMBER	DESCRIPTION	UNIT
1 74711-87870	70 sheets	EA
2 74711-35550	3/8" staples	2500/BX

Staplers – half strip



A BOSTITCH® INJOY™ ANTIMICROBIAL SPRING-POWERED COMPACT STAPLER

Antimicrobial properties built-in. One finger technology for easy spring-powered stapling. Built-in staple remover and integrated staple storage compartment. No-Jam technology for smooth, hassle-free stapling. Opens for bulletin board tacking and craft use. Compact and lightweight.

ORDER NUMBER	DESCRIPTION	UNIT
1510	20 sheets	EA



C SWINGLINE® OPTIMA® COMPACT STAPLER

Half strip. No adjustable anvil. Does not open for tacking. Uses standard staples. Silver.

ORDER NUMBER	DESCRIPTION	UNIT
74711-66412A	25 sheets	EA



E RAPID® F30 COMPACT HALF STRIP STAPLER

Uses half strip of standard staples. Staples up to 30 sheets. Flat clinch reduces height of your paper stack by 30%; ergonomic compact design. Does not open for tacking. Two year limited warranty. Black.

ORDER NUMBER	DESCRIPTION	UNIT
76082	30 sheets	EA



G SWINGLINE® E-Z GRIP™ STAND-UP STAPLER

Staples up to 15 sheets of standard paper. Uses half strip of standard staples. Adjustable anvil.

ORDER NUMBER	DESCRIPTION	UNIT
74711-78890	15 sheets	EA

B SWINGLINE® 747® RIO RED COMPACT STAPLER



Metal construction with die-cast base for maximum durability. Locking latch secures staple position. Half strip. Adjustable anvil. Opens for tacking. Uses standard staples. Limited lifetime warranty. Red.

ORDER NUMBER	DESCRIPTION	UNIT
64474-74750	25 sheets	EA



D BOSTITCH® B400 STAPLER

All metal construction for durability. Opens for tacking. Dual clinch system for permanent or temporary stapling. Staple reload alert window.

ORDER NUMBER	DESCRIPTION	UNIT
B400-BLACK	20 sheets	EA



F BOSTITCH® B8® STAPLER WITH REMOVER

Half strip stapler with durable all-metal design; built in staple remover. Removable desktop base and lock for optimized travel portability. Staples 2-30 sheets of 20 lb. paper. Opens for tacking. Lifetime Limited Warranty.

ORDER NUMBER	DESCRIPTION	UNIT
1 B8RC	30 sheets	EA
2 STCRP2115-¼	¼" Powercrown staples	5000/BX



H BOSTITCH® B175 ELECTRO FLAT CLINCH STAPLER

All metal construction. Half strip. 40 sheets. Opens for tacking. Uses standard staples.

ORDER NUMBER	DESCRIPTION	UNIT
1 B175-BLUE-M	Metallic Blue	EA
2 B175-CHROME	Chrome	EA
3 B175-GOLD	Gold	EA
4 B175-PURPLE-M	Metallic Purple	EA

Staplers – heavy duty

A SWINGLINE® 390 HEAVY DUTY STAPLER

Contoured handle design with comfort grip. Staples up to 160 sheets. Sturdy all-metal construction and working parts. Adjustable paper stop. Uses ¼" to ¾" SF-13 heavy duty staples.



ORDER NUMBER	DESCRIPTION	UNIT
74711-39002	160 sheets	EA



B BOSTITCH® NO-JAM™ ANTIMICROBIAL EXTRA HEAVY DUTY STAPLER

Antimicrobial properties built-in. Staples up to 215 sheets. Adjustable paper stop for consistent staple placement; adjustable anvil. Uses ¼" to ⅝" SB35 staples. Limited Lifetime Warranty.



ORDER NUMBER	DESCRIPTION	UNIT
00540	215 sheets	EA



C BOSTITCH® ANTIMICROBIAL 130 SHEET HEAVY DUTY STAPLER

Durable steel construction. Antimicrobial properties built-in. Takes up to ⅝" staple for a maximum capacity of 130 sheets. Adjustable paper stop. Easy rear staple loading. Uses SB35 heavy duty staples. Limited Lifetime Warranty.



ORDER NUMBER	DESCRIPTION	UNIT
B310HDS	130 sheets	EA

D SWINGLINE® LIGHT TOUCH™ HEAVY DUTY STAPLER

Less pounds of pressure than any heavy-duty stapler on the market. 120 sheet capacity (20 lb paper). All metal construction, adjustable throat depth and full rubber base.



ORDER NUMBER	DESCRIPTION	UNIT
1 74711-90010	120 sheets	EA
2 74711-90009	Staples	2500/BX



E RAPID® HD80 HEAVY DUTY STAPLER

Staples up to 80 sheets. All metal inner housing. Low staple indicator. Contains 100% post-consumer recycled plastic. Five year limited warranty. Black.



ORDER NUMBER	DESCRIPTION	UNIT
1 73159	80 sheets	EA
2 74711-35318	⅝" staples (60 sheets)	1000/BX
3 74711-35312	½" staples (90 sheets)	1000/BX



F BOSTITCH® 65 ANTIMICROBIAL PREMIUM HEAVY DUTY STAPLER

Antimicrobial properties built-in. Two-finger easy spring-powered stapling technology. Staples up to 65 sheets. Die-cast metal with a soft rubber grip.



ORDER NUMBER	DESCRIPTION	UNIT
1 1210	65 sheets	EA
2 1962	⅝" staples	3000/BX

G BOSTITCH® PHD-60 PERSONAL HEAVY DUTY STAPLER

No-Jam™ design for trouble free stapling. Bypass clinch system for a more professional appearance. Full rubber base pad keeps the stapler in place during high volume use. Anvil is not adjustable.



ORDER NUMBER	DESCRIPTION	UNIT
1 PHD60	60 sheets	EA
2 SB35PHD-5M	½" staples	5000/BX

Check online for the most current price.

Staplers – electric and specialty



A BOSTITCH® B8® IMPULSE™ 45 ELECTRIC STAPLER

Uses B8® PowerCrown™ staples. Packaged with 5,000 ¼" staples. Staples up to 45 sheets, jam-free. Low staple indicator light. Staples stacks in just a fraction of a second. Six-foot power cord. UL/CSA approved. 7-Year limited warranty.

ORDER NUMBER	DESCRIPTION	UNIT
1 B8E-VALUE	45 sheets	EA
2 STCRP2115-1/4	¼" Staples	5000/BX
3 STCR2115-3/8	⅜" Staples	5000/BX



B SWINGLINE® LONG REACH STAPLER

All metal construction. Staples up to 20 sheets; 12" reach. Features an integrated ruler and adjustable locking paper guide. Jam resistant inner rail.

ORDER NUMBER	DESCRIPTION	UNIT
1 74711-34121	20 sheets	EA
2 74711-35454	Staples	3750/BX

C RAPID® 20EX PERSONAL ELECTRIC STAPLER

Features a compact design and an easy, front-loading system; half strip. Uses AC adapter (included). Staples up to 20 sheets. 2-Year limited warranty. Black.



ORDER NUMBER	DESCRIPTION	UNIT
1 73126	20 sheets	EA
2 74711-35454	Staples	3750/BX

D RAPID® CLASSIC K1 PLIER STAPLER

All chrome plated metal construction. Fifty sheet capacity using ⅝" staples; also compatible with standard size staples. Features an adjustable anvil for temporary stapling. Made in Sweden; 5-year limited warranty.



ORDER NUMBER	DESCRIPTION	UNIT
1 90119	Stapler	EA
2 90003	⅝" staples	5000/BX

E SWINGLINE® BREEZE AUTOMATIC STAPLER

Powered by 4 AA batteries (not included). Clear view window so you can see where you're stapling. Low-battery light. Automatically staples up to 20 sheets. Easy push-button staple loading. Uses SF-4 staples.



ORDER NUMBER	DESCRIPTION	UNIT
1 74711-42132	20 sheets	EA
2 74711-35454	Staples	3750/BX



F BOSTITCH® MDS20 PORTABLE ELECTRIC STAPLER

On your desk or on the go! Plugs into an outlet or runs on batteries. FastLoad™ quick and easy push-button staple reloading. Extra-wide lead-in for quick paper placement. Half strip. Black.

ORDER NO.	DESCRIPTION	UNIT
1 MDS20-BLK	20 sheets	EA
2 SBS191/4CP	¼" staples	5000/BX

G WESTCOTT® CLAW STYLE STAPLE REMOVER

Easy to use pincher mechanism.



ORDER NUMBER	UNIT
65956-21550	EA

H BOSTITCH® MAGNETIC STAPLE REMOVER

Push style; removes staples without tearing paper. Magnetic pick-up; bi-material construction.



ORDER NUMBER	UNIT
4000M-BLK	EA

Our Brand, YOUR Savings!



A OP BRAND STANDARD STAPLES

Chisel pointed. Fits all standard staplers. Box of 5000, 210 staples per strip.

ORDER NUMBER	UNIT
27811-10026	BX



D SWINGLINE® SF-1 STANDARD STAPLES

Chisel pointed. Fits all standard staplers. Box of 5000, 210 staples per strip.

ORDER NUMBER	DESCRIPTION	UNIT
74711-35108	¼"	BX



G RAPID® STAPLES

Galvanized staples compatible with electric and high capacity staplers. Box of 5000.

ORDER NUMBER	DESCRIPTION	UNIT
90003	⅝", 2-50 sheets	BX



J BOSTITCH® PAPERPRO® PREMIUM STANDARD STAPLES

Premium standard staples designed for use with PaperPro Desktop, Prodigy Staplers and most standard staplers. Staples up to 25 sheets. 5000/box.

ORDER NUMBER	DESCRIPTION	UNIT
1901	¼"	BX



B SWINGLINE® S.F.4® PREMIUM STAPLES

Highest quality standard staples feature round wire for greater strength and chisel point for easier penetration. Box of 3750.

ORDER NUMBER	DESCRIPTION	UNIT
74711-35454	¼"	BX



E SWINGLINE® SF-13 HEAVY DUTY STAPLES

Box of 1000.

ORDER NUMBER	DESCRIPTION	UNIT
1 74711-35314	¼" (30 sheets)	BX
2 74711-35318	⅜" (60 sheets)	BX
3 74711-35312	½" (90 sheets)	BX
4 74711-35319	¾" (160 sheets)	BX



H BOSTITCH® SB35 HEAVY DUTY STAPLES

For Bostitch® heavy duty staplers. Box of 1000.

ORDER NUMBER	DESCRIPTION	UNIT
1 SB351/4-1M	¼", 2-25 sheets	BX
2 SB353/8-1M	⅜", 25-55 sheets	BX
3 SB351/2-1M	½", 55-85 sheets	BX
4 SB355/8-1M	⅝", 85-130 sheets	BX
5 SB3513/16HC-1M	1⅜", 130-165 sheets	BX
6 SB3515/16HC-1M	1⅝", 165-215 sheets	BX



K BOSTITCH® B8® POWER CROWN STAPLES

Design forces more strength to staple legs. Box of 5000.

ORDER NUMBER	DESCRIPTION	UNIT
1 STCRP2115-1/4	¼"	BX
2 STCR2115-3/8	⅜"	BX



C SWINGLINE® STAPLE CARTRIDGE FOR ELECTRIC STAPLERS

For Swingline® 690E electronic staplers. Also fits many photocopiers equipped with an automatic stapler. 30 sheets. 5000/cartridge.

ORDER NUMBER	DESCRIPTION	UNIT
74711-50050	¼"	PK



F SWINGLINE® OPTIMA® JAM FREE PREMIUM STAPLES

FOR DESKTOP, GRIP & ELECTRIC OPTIMA

1 74711-35556

3750/BX

FOR OPTIMA 70, EASY TOUCH LEVER DESKTOP

2 74711-35550

2500/BX



I BOSTITCH® SP191/4 POWERCROWN™ PREMIUM STAPLES

For P3-Chrome Plier stapler. ¼" (6mm) leg.

ORDER NUMBER	UNIT
SP191/4	5000/BX



L BOSTITCH® HEAVY DUTY STAPLES

For Bostitch® heavy duty staplers. Box of 3000.

ORDER NUMBER	DESCRIPTION	UNIT
1962	⅝", 65 sheets	BX

OFFICE SUPPLIES

Our Brand, YOUR Savings !



**A OP BRAND
THREE-HOLE ADJUSTABLE PUNCH**

Adjustable heads to punch 2 or 3 holes, 1/4" diameter. Maximum capacity: 14 letter size sheets.



ORDER NUMBER	DESCRIPTION	UNIT
27811-10027	14 sheet capacity	EA

**B WESTCOTT®
SINGLE HOLE PUNCHES**

Plier style, single hole punches with waste receptacle. Choice of 1/4" or 3/8" diameter hole.



ORDER NUMBER	DESCRIPTION	UNIT
1 65956-11230	1/4" hole, 5 sheet capacity	EA
2 65956-00588	3/8" hole, 5 sheet capacity	EA

**C BOSTITCH® EZ SQUEEZE™
ONE-HOLE PUNCH**

Low force design – 50% easier to use than standard one-hole punch. Jam free; punches up to 10 sheets; non-slip rubber handle with waste chamber.



ORDER NUMBER	DESCRIPTION	UNIT
2402	10 sheet capacity	EA

**D OFFICEMATE®
TWO-HOLE PUNCH**

For accurate hole punching when using prong fasteners. 2 holes x 1/4". Fixed punch heads. Adjustable paper guides and padded locking handle.



ORDER NUMBER	DESCRIPTION	UNIT
90082-VIC	50 sheets	EA

**E SWINGLINE®
EASYVIEW™
TWO-HOLE PUNCH**

Durable die cast metal construction. Unique safe design prevents finger pinching. Alignment indicators turn green when paper is positioned correctly for perfect punch holes every time. Up to 20 sheet punching capacity. Silver/black.



ORDER NUMBER	DESCRIPTION	UNIT
50505-74055	20 sheet capacity	EA

**F SWINGLINE® 5X®
ECONOMY TWO-HOLE PUNCH**

The 5X® punches two holes, 1/4" diameter, 2 3/4" centre-to-centre. Maximum capacity: 24 sheets of 20 lb bond paper.



ORDER NUMBER	DESCRIPTION	UNIT
50505-74105	24 sheet capacity	EA

**G SWINGLINE® 10X®
TWO-HOLE PAPER PUNCH**

Adjustable guide. Will punch two 1/4" holes (2 3/4" centre-to-centre) in up to 28 sheets of 20 lb bond paper.



ORDER NUMBER	DESCRIPTION	UNIT
50505-74101	28 sheet capacity	EA

OFFICE
SUPPLIES

A BOSTITCH® PUNCHES

Advanced cutting dies; low force design. Jam free and 50% easier to use than standard punches. Easy to empty waste chamber; paper guide for accurate punching; non-slip rubber base. Handle locks in down position for easy storage.



ORDER NUMBER	DESCRIPTION	UNIT
1 2101	EZ Squeeze™ 12, 3-hole, 12 sheets	EA
2 2220	EZ Squeeze™ 20, 3-hole, 20 sheets	EA
3 2240	EZ Squeeze™ 40, 3-hole, 40 sheets	EA
4 2310 NEW!	EZ Squeeze™, 2-hole, 20 sheets	EA
5 2340	EZ Squeeze™, 2-hole, 40 sheets	EA

NEW!

B OFFICEMATE® HEAVY DUTY THREE-HOLE PUNCH

For accurate hole punching when using prong fasteners. 3 holes × 7/32". Adjustable paper guides, easy to empty chip tray, and ergonomic padded locking handle. Fixed punch heads.



ORDER NUMBER	DESCRIPTION	UNIT
90089	40 sheets	EA

C SWINGLINE® M12® ECONOMY 2-3-HOLE PUNCH

The M12™ is adjustable to punch 2 or 3 holes, 7/32" diameter. Maximum capacity: 8 letter size sheets.



ORDER NUMBER	DESCRIPTION	UNIT
50505-74003	8 sheet capacity	EA

D BOSTITCH® EXECUTIVE THREE-HOLE PUNCH

Sleek chrome design with metal construction for long lasting and reliable use. 3 holes × 7/32". Easy-to-clean chip tray. Rubber base pad for stability during use. Gold.



ORDER NUMBER	DESCRIPTION	UNIT
HP12-GOLD	12 sheets	EA

E SWINGLINE® PRECISION PRO® DESKTOP PUNCH

Patented pin technology for precise cutting action. Punches up to 10 sheets of 20 lb. paper. Metal punch construction; semi-adjustable punch heads.



ORDER NUMBER	DESCRIPTION	UNIT
50505-74037	10 sheet capacity	EA

F SWINGLINE® LIGHT TOUCH® LEVER OPERATED PUNCHES

Easily punches 12 or 20 sheets of 20 lb. bond paper. Punches large 7/32" holes. Adjustment allows a choice of 2-3 holes in variable positions. Black/Silver.



ORDER NUMBER	DESCRIPTION	UNIT
1 50505-74026	12 sheet capacity	EA
2 50505-74030	20 sheet capacity	EA

G SWINGLINE® OPTIMA® 20 ELECTRIC PUNCH

Portable, space saving design. Alignment indicator for precise punching; easy to use oversized activation button. With auto reverse feature and transparent, hinged chip door. Battery or AC powered; 20 sheet capacity; limited 2-year warranty.



ORDER NUMBER	DESCRIPTION	UNIT
50505-74520	20 sheet capacity	EA

Paper punches



A SWINGLINE® PROTEC™ SAFETY PUNCH

Durable die cast metal construction. Unique safe design. Alignment indicators turn green when paper is positioned correctly. Up to 30 sheet punching capacity. Silver/black.

ORDER NUMBER	DESCRIPTION	UNIT
50505-16453	30 sheet capacity	EA



B APSCO® 330A HEAVY DUTY THREE-HOLE PUNCH

Punch up to 30 sheets of 16 lb. bond; ¼" holes.

ORDER NUMBER	DESCRIPTION	UNIT
6253836000	30 sheet capacity	EA



C SWINGLINE® M110 HEAVY DUTY PUNCH

Punches three holes ½" in diameter in up to 30 sheets. Adjustable positions.

ORDER NUMBER	DESCRIPTION	UNIT
50505-74110	30 sheet capacity	EA



D SWINGLINE® M350 HEAVY DUTY ADJUSTABLE PUNCH

Lever-action handle punches ½" holes through up to 32 sheets with ease. Accepts up to 7 punch heads; adjustable for two or three holes.

ORDER NUMBER	DESCRIPTION	UNIT
50505-74350	32 sheet capacity	EA

E SWINGLINE® LIGHT TOUCH® HEAVY DUTY PUNCH

Guaranteed jam free performance. Adjustable punch heads and handle are fused into one mechanism for full pin control. Top-loading design. Low force requires 50% less effort. Punches three ½" holes in up to 40 sheets.

ORDER NUMBER	DESCRIPTION	UNIT
50505-74357	40 sheet capacity	EA



F SWINGLINE® SMARTTOUCH™ LOW FORCE PUNCH

Reduce the amount of effort it takes to hole punch with a soft grip, full length handle to increase leverage. Features a visible chip tray, handle locks down for compact storage. 3 holes×½". Punches 45 sheets. Fixed punch heads.

ORDER NUMBER	DESCRIPTION	UNIT
64474-19235	45 sheet capacity	EA



G BOSTITCH® XTREME HEAVY DUTY ANTIMICROBIAL PUNCH

Antimicrobial properties built-in. Punches up to 160 sheets; adjusts for punching 2 or 3, ½" holes. Heavy steel construction. Lifetime limited warranty.

ORDER NUMBER	DESCRIPTION	UNIT
03200	160 sheet capacity	EA



Ballpoint - Rollerball Highlighter - Fineliner



Exclusive canadian distributor of

DIXON® FEATURE



A DIXON® TRATTO-1 BALLPOINT PEN

Features a cap which, when twisted, reveals the pen tip like a retractable pen. With a tungsten carbide ball bearing set in a brass point. Smooth-flowing stroke. Colours: **1** Blue, **3** Black.

ORDER NUMBER	DESCRIPTION	UNIT
F83830_	Specify colour	50/BX



B ZEBRA Z-GRIP™ MAX RETRACTABLE BALLPOINT PEN

Soft latex free rubber tip; wide, comfortable barrel, metal clip. Medium point (1.0 mm). Colours: **10** Black, **20** Blue, **30** Red.



ORDER NUMBER	DESCRIPTION	UNIT	1-11	12
45888-224_	Specify colour	EA		



C PAPER MATE® FLEXGRIP® ULTRA RECYCLED RETRACTABLE BALLPOINT PEN

Textured rubberized barrel conforms to your grip, while a steel flange tip offers extra durability. Contains 55% recycled materials. Medium point colours: **1** Blue, **3** Black. Fine point colours: **6** Blue, **8** Black.



ORDER NUMBER	DESCRIPTION	UNIT	1-11	12
95_0131	Specify point/colour	EA		



D PAPER MATE® COMFORTMATE ULTRA™ RETRACTABLE PEN

Rubberized triangular barrel offers unsurpassed comfort. Medium colours: **1** Blue, **2** Red, **3** Black. Fine colours: **6** Blue, **8** Black.

ORDER NUMBER	DESCRIPTION	UNIT
63_0187	Specify point/colour	12/BX



E PAPER MATE® PROFILE® RETRACTABLE BALLPOINT PEN

Ultra low viscosity ink. Visible ink supply. Soft comfortable grip.

ORDER NUMBER	DESCRIPTION	UNIT
1 2006826	1.4 mm Blue	EA
2 2095470	1.0 mm Black	EA
3 2095462	1.0 mm Blue	EA



F BIC® SOFTFEEL® RETRACTABLE BALLPOINT PEN

Soft cushioned, rubberized barrel. Colours: **4** Blue, **6** Black, **8** Red.

ORDER NUMBER	DESCRIPTION	UNIT
70330-9143_	Medium point, specify colour	12/BX



G ZEBRA F-301 RETRACTABLE BALLPOINT PEN

Stainless steel barrel. Comfort finger grips. Refillable. Colours: **10** Black, **20** Blue.

ORDER NUMBER	DESCRIPTION	UNIT
45888-271_	0.7mm, specify colour	EA



H BIC® CLIC STIC® RETRACTABLE BALLPOINT PEN

The most economical, retractable ballpoint pen. Colours: **1** Blue, **3** Black.

ORDER NUMBER	DESCRIPTION	UNIT
1 70330-9043_	Medium, specify colour	12/BX
2 70330-19648	Medium, Black	24/BX



I PAPER MATE® FLEXGRIP® ELITE™ RETRACTABLE BALLPOINT PEN

Soft grip provides comfort for any writing position. Floating Ball® superior writing technology for super smooth writing. Medium point colours: **0** Black, **1** Blue.

ORDER NUMBER	DESCRIPTION	UNIT
8558_	Specify colour	EA



A PENTEL® FEEL IT! RETRACTABLE BALLPOINT PENS

Effortless writing that doesn't drag, blob, skip or scratch. Comfort grip. Medium point.

ORDER NUMBER	DESCRIPTION	UNIT
1 BX477BP2-A	Black	2/PK
2 BX477BP2-C	Blue	2/PK



C PAPER MATE® INKJOY® 700 RT RETRACTABLE BALLPOINT PEN

Featuring the revolutionary InkJoy® writing system. Optimized hourglass shape and rubberized grip for comfort and control; metal nosecone and plunger; durable metal clip. Medium 1.0 mm point. Colours: **7** Black, **6** Blue.

ORDER NUMBER	DESCRIPTION	UNIT
195134_	Specify colour	EA



D ZEBRA OLA™ RETRACTABLE BALLPOINT PEN

Rubberized barrel. Anti-skid grip. Medium point. Colours: **1** Black, **2** Blue, **8** Purple.

ORDER NUMBER	DESCRIPTION	UNIT
45888-235_0	Specify colour	EA



F PILOT® SUPER GRIP-G RETRACTABLE BALLPOINT PENS

Retractable ballpoint pen with oil based ink for smooth writing. Rubberized grip. Colours: **BK** Black, **BE** Blue.

ORDER NUMBER	DESCRIPTION	UNIT
1 BPGG-8R-M-__	Medium point, specify colour	EA
2 BPGG-8R-F-__	Fine point, specify colour	EA

ZEBRA FEATURE



B ZEBRA Z-GRIP® RETRACTABLE BALLPOINT PEN

Smooth-flowing ink. Barrel colour indicates ink colour for individual pens. Metal clip. Rubberized grip. Medium point. Colours: **1** Black, **2** Blue, **3** Red.

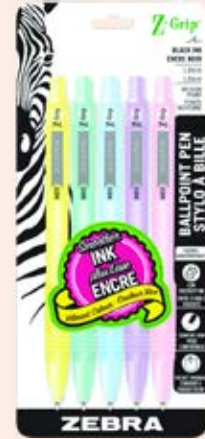

BUY MORE
SAVE MORE

ORDER NUMBER	DESCRIPTION	UNIT	1-11	12
1 45888-222_0	Specify colour	EA		
2 45888-22105	Pastel barrel / Black ink NEW!	5/PK		



E ZEBRA Z-GRIP™ FLIGHT RETRACTABLE PEN

Super smooth low-viscosity ink for no-fatigue writing. Sleek barrel with metal accents including double pocket clip. Latex-free soft rubber grip. Accent colours indicate ink colours. Non-refillable. 1.2mm point. Colours: **10** Black, **20** Blue.

ORDER NUMBER	DESCRIPTION	UNIT
45888-219_	Specify colour	EA



G ZEBRA JIMMIE® CLIP ECO RETRACTABLE BALLPOINT PEN

Heavy-duty spring-loaded clip. Medium point. Contains 68% post-consumer material. Refillable. 1.0mm. Colours: **10** Black, **20** Blue.

ORDER NUMBER	DESCRIPTION	UNIT
45888-225_	Specify colour	EA



I PAPER MATE® INKJOY® 300RT RETRACTABLE BALLPOINT PEN

Features Paper Mate's revolutionary InkJoy® writing system for effortless writing. Extended rubberized grip for optimal comfort; durable metal clip. Medium point; colours: **60** Black, **59** Blue, **58** Red.



ORDER NUMBER	DESCRIPTION	UNIT
1 19512_	Specify colour	12/BX
2 1945921	Assorted fashion colours	8/CD
3 1951378	Black	36/BX

BIC FEATURE

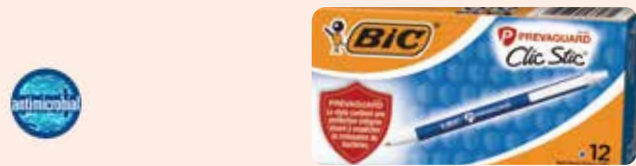

H BIC® PREVAGUARD™ CLIC STIC® RETRACTABLE BALLPOINT PENS

PrevaGuard™ an EPA registered antimicrobial additive, is moulded directly into the pen's plastic components to suppress the growth of bacteria, molds, mildew and fungi, especially in high-moisture environments. Break-resistant pocket clip. Medium point. Blue.

ORDER NUMBER	DESCRIPTION	UNIT
1 70330-53712		5/PK
2 70330-53707		12/BX





A BIC® GLIDE™ RETRACTABLE BALLPOINT PEN

A trusted original for a classic look and feel. Smoother than BIC® classic ink system. Cushioned grip. Medium point.

ORDER NUMBER	DESCRIPTION	UNIT
1 70330-14347	Black	EA
2 70330-14408	Blue	EA
3 70330-18488	Assorted NEW!	4/PK
4 70330-53467	Blue NEW!	24/BX



C PENTEL® GLIDEWRITE RETRACTABLE BALLPOINT PEN

Advanced ink formula TechniFlo makes this ink ultra smooth. Super low viscosity helps reduce the risk of buildup. Contoured rubberized grip. 1.0mm. Colours: **A** Black, **B** Red, **C** Blue, **D** Green, **P** Pink, **S** Sky Blue, **V** Purple..

ORDER NUMBER	DESCRIPTION	UNIT
BX910-__	Specify colour	EA



D UNI® JETSTREAM RETRACTABLE PEN

The low-viscosity Super Ink™ combines the quick drying time of a ballpoint with the vibrant color and smoothness of a gel pen. uni Super Ink™ technology protects against water, fading & fraud. Colours: **2** Black, **3** Blue, **4** Red.

ORDER NUMBER	DESCRIPTION	UNIT
7383__	Specify colour	EA



F BIC® GLIDE™ BOLD RETRACTABLE BALLPOINT PENS

Smooth writing and vivid lines. Feel the smoothness-! Rubberized grip. Extra Bold point, 1.6 mm.

ORDER NUMBER	DESCRIPTION	UNIT
1 70330-18510	Black	EA
2 70330-18509	Blue	EA
3 70330-52212	Black NEW!	36/BX
4 70330-52213	Blue NEW!	36/BX



H UNI® POWER TANK™ RT PEN

Performs under the toughest conditions. Pressurized ink cartridge allows for writing on wet surfaces, in extreme cold & at odd angles, including upside down. Ergonomic textured grip ensures lasting comfort while uni Super Ink™ technology protects against water, fading, & fraud. Colours: **0** Black, **1** Blue.

ORDER NUMBER	DESCRIPTION	UNIT
4207__	Specify colour	EA

uni. FEATURE



B UNI® JETSTREAM™ ELEMENTS RETRACTABLE BALLPOINT PENS

Exceptionally smooth and crisp. Low viscosity oil-based ink provides gel type experience in ballpoint. Shorter drying time. Rubberized grip. Bold point.

ORDER NUMBER	DESCRIPTION	UNIT
1 70180	Assorted colours	3/PK
2 70138C	Assorted colours	5/PK



E PAPER MATE® INKJOY® 100 RT RETRACTABLE BALLPOINT PEN

Featuring the revolutionary InkJoy® writing system. Sleek, tinted triangular barrel for more comfort. Medium 1.0 mm point. Colours: **2** Red, **3** Blue, **4** Black. Set of 8 colours include: Black, Blue, Red, Green, Orange, Pink, Purple and Turquoise.



ORDER NUMBER	DESCRIPTION	UNIT
1 195125__	Specify colour	12/BX
2 1945935	Set of 8 fashion colours	ST



G BIC® 4-COLOR™ 3+1 RETRACTABLE BALLPOINT PEN/PENCIL

World-renowned four-colour pen, now including a 0.7 mm pencil. Medium point. Includes lead refills and eraser.

ORDER NUMBER	DESCRIPTION	UNIT
70330-52274	Black, Blue and Red	EA



I BIC® 4-COLOR™ RETRACTABLE BALLPOINT PENS

Four-colour convenience in one pen. Medium 1.0 mm point.

ORDER NUMBER	DESCRIPTION	UNIT
1 70330-10010	Black, Blue, Red, Green	EA
2 70330-14540	Black, Blue, Red, Green NEW!	3/PK

Writing – retractable and stick ball point pens



A SCHNEIDER SLIDER RAVE RETRACTABLE BALLPOINT PEN

Viscoglide® technology for extraordinarily smooth gliding writing. Ink dries quickly and is smudgeproof. CO2 neutral, leaving no carbon footprint. Rubberized ergonomic grip. Extra broad point.

ORDER NUMBER	DESCRIPTION	UNIT
1 RS73251	Black	EA
2 RS73253	Blue	EA



C PILOT® BETTER RETRACTABLE BALL PEN

Crystal tinted barrel matches ink colour. Chrome pocket clip. Refillable. Fine Point. Colours: **BK** Black, **BE** Blue.

ORDER NUMBER	DESCRIPTION	UNIT	1-11	12
BP145-F-__	Specify colour	EA		



E PENTEL® R.S.V.P.® RETRACTABLE PENS

Safety colour barrel that is easy to see amongst toolboxes or active work environments. Rubber Comfort Zone™ grip with dimpled finger grips. Refillable. Bold point. Black.

ORDER NUMBER	DESCRIPTION	UNIT
1 BK93HDG-A	Yellow barrel	EA
2 BK93HDF-A	Orange barrel	EA



G PILOT® ACROBALL RETRACTABLE BALLPOINT PEN

Colours: **BE** Blue, **BK** Black, **RD** Red.

ORDER NUMBER	DESCRIPTION	UNIT
1 BPAB-25F-__	Fine point, specify colour	EA
2 BPAB-25M-__	Medium point, specify colour	EA



H SCHNEIDER SLIDER MEMO BALLPOINT PENS

Viscoglide® technology for extraordinarily smooth gliding writing. Ink dries quickly and is smudgeproof. CO2 neutral, leaving no carbon footprint. Rubberized ergonomic grip. Extra Broad point.

ORDER NUMBER	DESCRIPTION	UNIT
1 RS75021	Black	EA
2 RS75023	Blue	EA
3 RS150293	Assorted colours	3/PK
4 RS77341	Refill, Black	EA



B PENTEL® WOW!™ RETRACTABLE BALLPOINT PEN

Long triangular shaped barrel prevents rolling; latex free grip. Pen top advances tip, side button retracts. Medium 1.0 mm point; colours: **A** Black, **B** Red, **C** Blue.

ORDER NUMBER	DESCRIPTION	UNIT
1 BK440BP3-__	Specify colour	NEW! 3/PK
2 BK440-__	Specify colour	12/BX



D PAPER MATE® PROFILE® RETRACTABLE BALLPOINT PEN

Ultra low viscosity ink. Features vibrant ink, and a stainless steel barrel for premium look. Soft comfortable grip. 1.0 mm.

ORDER NUMBER	DESCRIPTION	UNIT
1 2130513	Black	2/PK
2 2130519	Blue	2/PK



F BIC® REVOLUTION™ OCEAN RETRACTABLE BALL POINT PENS

A better world is in your hands. We can write our planet's future together. Medium point. Blue.

ORDER NUMBER	DESCRIPTION	UNIT
1 70330-53687	73% ocean-bound recycled plastic,	4/PK
2 70330-53701	Contains a minimum of 62% post-consumer recycled material	10/PK



I SCHNEIDER SLIDER EDGE BALLPOINT PENS

Viscoglide® technology for extraordinarily smooth gliding writing. Ink dries quickly and is smudgeproof. CO2 neutral, leaving no carbon footprint. Rubberized three-edged barrel.

ORDER NUMBER	DESCRIPTION	UNIT
1 RS152289	Includes case stand, assorted pastel colours	8/PK
2 RS152290	Assorted colours	10/PK

Our Brand, YOUR Savings!



A OP BRAND BALLPOINT STICK PEN WITH RUBBER BARREL

Medium point; colours: **20** Black, **21** Blue.

ORDER NUMBER	DESCRIPTION	UNIT
27811-500__	Specify colour	12/BX



B OP BRAND BALLPOINT STICK PEN

Medium point colours: **14** Black, **15** Blue.

ORDER NUMBER	DESCRIPTION	UNIT
27811-500__	Specify colour	12/BX



C PENTEL® FEEL IT! STICK PEN

A low-viscosity ink for smoother writing that comes in bright dense colours. Won't drag, blob or scratch. Colours: **A** Black, **C** Blue.

ORDER NUMBER	DESCRIPTION	UNIT
BX487-__	Fine point, specify colour	EA



D BIC® ROUND STIC® BALLPOINT PEN

Round, flexible barrel for easy writing. Medium point colours: **18** Red, **19** Black, **20** Blue. Fine point colours: **29** Black, **30** Blue.

ORDER NUMBER	DESCRIPTION	UNIT
1 70330-201__	Specify point/colour	12/BX
2 70330-13161	Medium, Blue	60/BX
3 70330-13162	Medium, Black	60/BX



E PAPER MATE® COMFORTMATE ULTRA™ BALLPOINT STICK PEN

With comfortable non-slip rubber coated triangular barrel. Medium point colours: **1** Blue, **3** Black.

ORDER NUMBER	DESCRIPTION	UNIT
61_0187	Specify point/colour	12/BX



F BIC® ULTRA ROUND STIC GRIP™ BALLPOINT PEN

For a vivid ink laydown. Medium colours: **725** Blue, **726** Black, **889** Red. Fine colours: **902** Black, **903** Blue.

ORDER NUMBER	DESCRIPTION	UNIT
70330-13__	Specify point/colour	12/BX



G PAPER MATE® INKJOY® 100 BALLPOINT STICK PEN

Features Paper Mate's revolutionary InkJoy® effortless writing system. Triangular barrel. Medium 1.0 mm point.

ORDER NUMBER	DESCRIPTION	UNIT
1 1951256	Blue	12/BX
2 1782970	Fashion colours, assorted	10/PK



H BIC® CRISTAL® EXTRA SMOOTH BALLPOINT STICK PEN

Provides a vivid ink laydown. Clear barrel for visible ink supply. Roll-proof hexagonal design provides comfortable and controlled writing. Colours: **26** Blue, **27** Black, **28** Red.

ORDER NUMBER	DESCRIPTION	UNIT
1 70330-101__	Specify colour	12/BX
2 70330-16730	Assorted, 6 blue, 2 black, 2 red	10/PK



I UNI® JETSTREAM™ BALLPOINT PEN

The low-viscosity Super Ink™ combines the quick drying time of a ballpoint with the vibrant colour and smoothness of a gel pen. uni Super Ink™ technology protects against water, fading & fraud. **1** Black, **2** Blue, **3** Red.

ORDER NUMBER	DESCRIPTION	UNIT
1 3392__	1.0 mm, specify colour	EA
2 40173	0.7mm, Black	EA
3 40174	0.7mm, Blue	EA



J SCHNEIDER TOPS 505 BALLPOINT STICK PENS

A pen with a clip cap that fits neatly on either end of the pen. Wear-resistant, stainless steel tip. Hexagonal transparent barrel. Medium point.

ORDER NUMBER	DESCRIPTION	UNIT
1 RS150801	Black	10/BX
2 RS150803	Blue	10/BX
3 RS150802	Red	10/BX



A PAPER MATE® FLEXGRIP® ULTRA RECYCLED STICK PEN

Comfortable, non-slip rubber barrel. Contains 55% recycled material. Medium point colours: **1** Blue, **2** Red, **3** Black. Fine point colours: **6** Blue, **8** Black.

**BUY MORE
SAVE MORE**

ORDER NUMBER	DESCRIPTION	UNIT	1-11	12
96_0131	Specify point/colour	EA		



C PAPER MATE® FLEXGRIP® ELITE™ BALLPOINT PEN

Soft full length grip that provides comfort for any writing position. Floating Ball™ superior writing technology for super smooth writing. Medium point colours: **85** Black, **86** Blue.

ORDER NUMBER	DESCRIPTION	UNIT
855__	Specify colour	EA



D ZEBRA JIMNIE® STICK BALLPOINT PEN

Rubberized grip. Colours: **10** Black, **20** Blue.

ORDER NUMBER	DESCRIPTION	UNIT
1 45888-210__	Fine point, specify colour	EA
2 45888-211__	Medium point, specify colour	EA

NEW!



F BIC® REVOLUTION™ STICK BALL POINT PENS

Environmentally-friendly pen that is ideal for everyday writing. Contains a minimum of 62% post-consumer recycled material. Blue.



ORDER NUMBER	DESCRIPTION	UNIT
70330-53699	Medium point	10/BX



H PENTEL® SUPERB® BK-77® BALLPOINT PEN

Translucent barrel shows ink level. Fine point. Colours: **A** Black, **C** Blue, **D** Green **V** Purple.

ORDER NUMBER	DESCRIPTION	UNIT
BK77-__	Specify colour	EA

Paper Mate® **FEATURE**



B PAPER MATE® WRITE BROS® BALLPOINT PEN

Economical, durable pen in choice of medium or fine points.

ORDER NUMBER	DESCRIPTION	UNIT
1 2124515	Fine, Black	12/BX
2 2124512	Fine, Blue	12/BX
3 2124517	Fine, Red	12/BX
4 3331131C	Medium, Black	12/BX
5 4621401C	Medium, Black	60/BX
6 3311131C	Medium, Blue	12/BX
7 4621501C	Medium, Blue	60/BX
8 3321131C	Medium, Red	12/BX



E PILOT® SUPER GRIP-G STICK PENS

Smooth writing with oil-based ink. Refillable. Long rubberized grip with distinctive grid pattern provides wide grip area and comfortable writing. Colours: **BE** Blue, **BK** Black.

ORDER NUMBER	DESCRIPTION	UNIT
1 BPS-GG-F-__	Fine point, specify colour	EA
2 BPS-GG-M-__	Medium point, specify colour	EA



G PENTEL® R.S.V.P.® BALLPOINT PEN

Economical ballpoint pen with clear barrel, grooved rubberized grip and pocket clip on cap. Dark vivid ink. Fine point colours: **A** Black, **B** Red, **C** Blue, **D** Green, **P** Pink, **V** Violet. Medium point colours: **A** Black, **B** Red, **C** Blue, **D** Green, **V** Violet.

**BUY MORE
SAVE MORE**

ORDER NUMBER	DESCRIPTION	UNIT	1-11	12
1 BK90-__	Fine point, specify colour	EA		
2 BK91-__	Medium point, specify colour	EA		
3 BK90BP5M	Fine point, assorted NEW!	5/PK		



I PILOT® BPS BALLPOINT STICK PEN

Refillable ballpoint pen with tinted crystal barrel features a tungsten carbide ball in a stainless steel tip. Colours: **BE** Blue, **BK** Black, **RD** Red, **PE** Purple.

**BUY MORE
SAVE MORE**

ORDER NUMBER	DESCRIPTION	UNIT	1-11	12
1 BPS-F-__	Fine point, specify colour	EA		
2 BPS-M-BE	Medium point, Blue	EA		
3 BPS-M-BK	Medium point, Black	EA		



ENERGEL®

Pentel® EnerGel Retractable Gel Roller (0.7mm) BL77PC12-M

Pentel EnerGel, an effortless writing experience in twelve vibrant colours. Internally tested to be smoother writing than the leading gel pen on standard writing paper. Liquid gel ink dries fast. Left-handed writers love it; no smears, no smudges, no globs. Refillable with LR7 EnerGel refills. Reduce your environmental impact by refilling your pens.

FOLLOW US ON SOCIAL MEDIA
PENTEL CANADA



Discover the best

Pentel



A PENTEL® ENERGEL® RTX® RETRACTABLE PERMANENT GEL PEN

Permanent, acid free, archival quality, ink. Perfect for writing cheques to avoid fraud. Water proof and light proof. Made of recycled plastic and features a latex free grip. Colours: **A** Black, **C** Blue.

ORDER NUMBER	DESCRIPTION	UNIT
BLP75-__	Specify colour	EA



C PENTEL® ENERGEL® RETRACTABLE PINK RIBBON GEL ROLLER

Feature's Pentels advanced blend of super-smooth liquid and gel inks. Vivid, acid-free ink dries quickly without smearing or blotting. **\$0.05** from each one purchased will go to the Breast Cancer Research Foundation. Refillable.

ORDER NUMBER	DESCRIPTION	UNIT	1-11	12
BL77P-ABC	0.7mm, Black	EA		



E PENTEL® ENERGEL® LIQUID GEL ROLLER PENS

Metal tip. Colours: **A** Black, **B** Red, **C** Blue, **D** Green, **V** Violet.

ORDER NUMBER	DESCRIPTION	UNIT	1-11	12
1 BLN73-__	0.3 mm Specify A, B or C only	EA		
2 BLN75-__	0.5 mm Specify A, B or C only	EA		
3 BL77-__	0.7 mm Specify colour	EA		
4 BL77CA-C1	"Canada" Pen, Blue	EA		
5 BL77BP3-M	0.7 mm Red, Green, Violet	3/PK		
6 BL77BP4-M	0.7 mm Black, Blue, Red, Green	4/PK		
7 BL77PC12-M	0.7 mm Assorted	12/BX		

Pentel FEATURE



G PENTEL® ENERGEL® 3 REFILLABLE RETRACTABLE 3-IN1 GEL PEN

Multi-functional pen contains three different ink colours. Sleek & stylish white barrel design with metal accents for a professional look. Latex-free grip.

ORDER NUMBER	DESCRIPTION	UNIT
BLC35W	0.5 mm Black, Blue and Red	EA

Pentel FEATURE



B PENTEL® ENERGEL®-X RETRACTABLE GEL ROLLER PEN

Smooth flowing, quick drying ink; 0.5 mm or 0.7 mm point. Colours: **A** Black, **B** Red, **C** Blue.

ORDER NUMBER	DESCRIPTION	UNIT
1 BLN105-__	0.5 mm needle point, specify colour	EA
2 BL107-__	0.7 mm metal point, specify colour	EA
3 BL110-__	1.0 mm point, Black or Blue only	EA



D UNI® 207™ RETRACTABLE GEL PEN

Comfortable textured grip allows for control as smooth, even-flowing uni Super Ink™ locks in & protects ideas from water, fading & fraud. Fine (0.5mm) point colours: **5** Black, **6** Blue. Medium (0.7mm) point colours: **0** Black, **1** Blue, **2** Red. Needle point colours: **7** Black, **8** Blue.

ORDER NUMBER	DESCRIPTION	UNIT	1-11	12
1 6125__	Fine point, specify colour	EA		
2 3395__	Medium point, specify colour	EA		
3 173609__	Needle point, specify colour	EA		
4 1790896	Bold point, Blue	EA		
5 1739929C	Medium point, Assorted Fashion Colours	8/PK		



F UNI® 307™ RETRACTABLE GEL PENS

World's first consumer application of high-tech Nano Fiber Ink. Superior smoothness, drying-speed, and line intensity. Write or draw effortlessly - even on glossy paper. uni Super Ink™ PLUS+ technology protects against water, fading & fraud.

ORDER NUMBER	DESCRIPTION	UNIT
1927258	0.7mm, Black	EA



NEW!

H ZEBRA BLEN RETRACTABLE GEL PEN

Internal system eliminates gaps in each part of the pen. Designed with a lower center of gravity by placing a brass weight at the tip. Removes uncomfortable writing vibrations making the pen more stable, noise-free, and easier to control.

ORDER NUMBER	DESCRIPTION	UNIT
45888-41402	0.7mm, Black	2/PK

uni. FEATURE

A UNI® ONE RETRACTABLE GEL PENS

Darker intense ink. Specially pigmented to suppress its penetration into the paper which makes it dark, vivid and crisp. 0.7 mm.



ORDER NUMBER	DESCRIPTION	UNIT
1 70322C	Black	3/PK
2 70323C	Blue	3/PK
3 70324C	Assorted Fashion Colours	5/PK
4 70362	NEW! Black	12/BX
5 70363	NEW! Blue	12/BX



D BIC® GEL-OCITY® ORIGINAL RETRACTABLE GEL PENS

Smooth writing with a contoured grip for comfort and control. Ergonomic barrel. 0.7 mm. Refillable. Colours: **3** Black, **4** Blue.

ORDER NUMBER	DESCRIPTION	UNIT
1 70330-3156	Specify colour	EA
2 70330-35569	Assorted	8/PK



F PILOT® BEGREEN™ B2P RETRACTABLE GEL PEN

The first pen made from recycled plastic water bottles; 89.9% recycled content (not including replaceable parts). Acid free, archival safe ink; medium (0.7 mm) point. Colours: **BK** Black, **BE** Blue, **RD** Red.



ORDER NUMBER	DESCRIPTION	UNIT
BG-BLB2P-7__	Specify colour	EA

NEW!

G ZEBRA SARASA® CLIP DECOSHINE RETRACTABLE GEL PENS

Beautiful shiny colours with a shimmering sheen that adds just enough glitz to your artwork or everyday writing. Water-based archival quality pigment ink. Water resistant. 1.0 mm.



ORDER NUMBER	DESCRIPTION	UNIT
45888-49009	Assorted Metallic colours	9/PK

B PENTEL® ENERCEL® RETRACTABLE GEL PENS

Quality, economical gel pens. Rubberized grip. Refillable. Black barrel. 0.7 mm. Assorted colours.

ORDER NUMBER	UNIT
BL437RPC12	12/PK



C PAPER MATE® PROFILE GEL RT PEN

Features bright, smooth, gel ink and the signature Profile® grip for comfortable all day writing. 0.7mm.

ORDER NUMBER	DESCRIPTION	UNIT
1 2095476	Black	EA
2 2095472	Blue	EA
3 2095469	Assorted	4/PK



E PENTEL® ENERCEL® INFREE® RETRACTABLE GEL PEN

Smooth, quick-drying gel, no globs or smears. Crystal clear barrel display allows you to customize and display your refill. Finger-print like grip. Colours: **A** Black, **C** Blue, **CA** Midnight Blue, **F** Orange, **S3** Turquoise.

ORDER NUMBER	DESCRIPTION	UNIT
BLN75TL-__	Specify colour	EA

Paper Mate® FEATURE



H PAPER MATE® INKJOY® RETRACTABLE GEL PENS

Bright, bold colours and a premium ink system for super-smooth ink that delivers crisp, clean lines. Designed for comfort and style. Full length grip.

ORDER NUMBER	DESCRIPTION	UNIT
1 1959314	0.7 mm Black	EA
2 1951717	0.5 mm Assorted colours	6/PK
3 1959301	0.7 mm Assorted colours	10/PK
4 1959302	0.7 mm Assorted colours	14/PK
5 2162814	0.7 mm Pastel colours	6/PK
6 2162815	0.7 mm Power colours	6/PK

NEW!
NEW!

ZEBRA FEATURE



A ZEBRA SARASA® RETRACTABLE GEL PEN

Rapid dry ink! Soft rubber grip provides writing comfort and control. Smooth gel ink dries almost instantly on various surfaces. No more smudging! Great for lefties. Refillable. Colours: 0.5mm - **10** Black, **20** Blue, **30** Red; 0.7mm - **810** Black, **820** Blue, **830** Red, **920** Cobalt, **930** Port, **940** Hunter green; 1.0mm - **10** Black, **20** Blue.

**BUY MORE
SAVE MORE**

ORDER NUMBER	DESCRIPTION	UNIT	1-11	12
1 45888-467	0.5 mm, specify colour	EA		
2 45888-46	0.7 mm, specify colour	EA		
3 45888-466	1.0 mm, specify colour	EA		



D PILOT® G2 RETRACTABLE GEL PEN

With rubber grip. Colours: **BK** Black, **BE** Blue, **RD** Red.

**BUY MORE
SAVE MORE**

ORDER NUMBER	DESCRIPTION	UNIT	1-11	12
1 BLG2-5-	0.5 mm, specify colour	EA		
2 BLG2-7-	0.7 mm, specify colour	EA		
3 BLG2-10-	1.0 mm, specify colour, Black or Blue only	EA		



F ZEBRA SARASA® CLIP GEL PEN

Softly coloured, opaque inks that show up well on light and dark coloured papers. They can even be used on glossy photos! Like all Sarasa Clip colours, Sarasa Milk features water-based pigment ink that is acid free, archival quality, and water resistant for a long-lasting impression. 0.5 mm.

ORDER NUMBER	DESCRIPTION	UNIT
45888-46708	Assorted Milk colour	8/PK



B ZEBRA GR8 RETRACTABLE GEL PEN

With soft rubber grip; acid free, archival quality ink. Colours: **10** Black, **20** Blue, **80** Purple.

**BUY MORE
SAVE MORE**

ORDER NUMBER	DESCRIPTION	UNIT	1-11	12
45888-426	Specify colour	EA		



C ZEBRA Z-GRIP® RETRACTABLE GEL PEN

Metal clip. Soft rubber grip. 0.7 mm. Colours: **10** Black, **20** Blue, **30** Red, **40** Green.

ORDER NUMBER	DESCRIPTION	UNIT
45888-424	Specify colour	EA



E ZEBRA SARASA® CLIP ECO RETRACTABLE GEL PEN

Rapid dry ink. Soft rubber grip. Contains a minimum of 57% recycled material. Refillable. Colours: **10** Black, **20** Blue.

ORDER NUMBER	DESCRIPTION	UNIT
45888-411	0.7mm, specify colour	EA

uniball FEATURE



G UNIBALL® 207 PLUS+ GEL RETRACTABLE PEN



Uni Super ink Plus with nano fibre ink - is the world's first consumer application of a plant fibre, molecule-based super strong ink. This environmentally friendly ink is derived from trees, rice, straw, and orange peels. Super enhanced smoothness, drying speed, and line intensity. Textured grip. 0.7 mm.

ORDER NUMBER	DESCRIPTION	UNIT
1 70456	Black	3/PK
2 70462	Black	12/BX
3 70463	Blue	12/BX
4 70464	Red	12/BX
5 70455	NEW! Black	36/BX

Writing – retractable gel pens



A SHARPIE® S-GEL® RETRACTABLE PENS

Always vivid ink won't smear or bleed. Contoured grip for comfortable writing.

ORDER NUMBER	DESCRIPTION	UNIT
0.5 mm		
1	2105285 Black	NEW! 2/PK
2	2096145 Black	12/BX
3	2096146 Blue	12/BX
4	2096166 Red	12/BX
0.7 mm		
5	2105288 Black	NEW! 2/PK
6	2105287 Blue	NEW! 2/PK
7	2096159 Black	12/BX
8	2096152 Blue	12/BX
9	2096158 Red	12/BX
10	2144798 1 each Black, Blue, Red, Green	4/PK
11	2105290 2 Black, 1 Blue, 1 Red	NEW! 4/PK
1.0 mm		
12	2096149 Black	12/BX
13	2096187 Blue	12/BX

C SHARPIE® S-GEL® FASHION RETRACTABLE PENS

With no smear, no bleed technology, this pen delivers an exceptional writing experience. 0.7mm Black ink.



ORDER NUMBER	DESCRIPTION	UNIT
1	2144799 White Barrel	2/PK
2	2144800 Blue Barrel	2/PK

E SHARPIE® S-GEL® METAL BARREL RETRACTABLE PENS

High-performance gel pen with a sleek metal barrel. With no smear, no bleed technology and bold, unrivaled ink, that delivers always-vivid writing. 0.7mm.



ORDER NUMBER	DESCRIPTION	UNIT
1	2147523 Gunmetal Barrel, Black ink	2/PK
2	2147524 Gunmetal Barrel, Blue ink	2/PK
3	2147527 Rose Gold Barrel, Black Ink	2/PK

uni. FEATURE



B UNI® SPECTRUM GEL RETRACTABLE PENS

Sleek modern sophisticated design. Innovative tip is rounded and edgeless to reduce friction against the paper, resulting in a super-smooth writing experience. Uni super ink protects against water, fading and fraud. Rubberized grip. 0.7 mm.

ORDER NUMBER	DESCRIPTION	UNIT
1	70181C Black	3/PK
2	70182C Blue	3/PK
3	70183C Assorted Fashion colours	6/PK
4	70359 Black	NEW! 12/BX
5	70360 Blue	NEW! 12/BX



D ZEBRA Z-GRIP® MAX RETRACTABLE GEL PEN

Affordable gel pen with wide barrel for added comfort. Soft rubber grip, sturdy metal clip; medium 0.7mm point, acid-free ink. Colours: **10** Black, **20** Blue, **30** Red.

ORDER NUMBER	DESCRIPTION	UNIT
45888-422_	Specify colour	EA

PILOT FEATURE



F PILOT® SYNERGY POINT RETRACTABLE GEL PEN

Needlepoint rolling ball with conical tip for silky smooth writing. Water-based gel pigment ink. On/off retractable indicator. Refillable. 0.5 mm.

ORDER NUMBER	DESCRIPTION	UNIT
1	BLRT-SNP5-BK Black	EA
2	BLRT-SNP5-BE Blue	EA
3	BLRT-SNP5-RD Red	EA

**FROM THE MARKER
FOR EVERYTHING...**



**COMES THE PEN FOR
EVERYTHING ELSE**



Sharpie®

S-GEL™

Every Desk Needs A Sharpie®



No Smear, No Bleed Technology

**Intensely Bold Gel Ink Colours
Offer Always Vivid Writing**

**Available In A Range Of
Colours and Designs**

Ink Colours Offered



Black, Blue, Red, Purple or Green Ink

Barrel Colours



Black, Pearl White or
Frost Blue Plastic Barrel



Gunmetal Gray or
Champagne Metal Barrel

Tip Availability

0.5mm
Fine Point

0.7mm
Medium Point

1.0mm
Bold Point



NEW!



A BIC® GEL-OCITY® STIC GEL PENS

Writes smooth and vibrant every time. Quick-drying ink helps prevent smearing. Convenient cap clip allows easy carrying.

ORDER NUMBER	DESCRIPTION	UNIT
1 70330-36443	0.5 mm, assorted colours	8/PK
2 70330-53826	0.7 mm, assorted colours	8/PK
3 70330-37362	0.7 mm, Black	12/BX



C PENTEL® ENERGEL® LIQUID GEL ROLLER PEN

Metal tip, 0.7 mm. Colours: **A** Black, **B** Red, **C** Blue, **V** Violet.

ORDER NUMBER	DESCRIPTION	UNIT
BL17-__	Specify colour	EA



E UNI® GEL GRIP™ PENS

A dimpled grip offers exceptional comfort through long writing sessions. Silky-smooth acid-free gel ink delivers rich, vibrant colours. uni Super Ink™ technology protects against water, fading, & fraud. Non-Refillable. Medium point. Colours: **0** Black, **1** Blue, **2** Red.

ORDER NUMBER	DESCRIPTION	UNIT
6545_	Specify colour	EA

NEW!



G PENTEL® ENERGEL® NEEDLE TIP GEL PEN

The best qualities of liquid ink and gel ink. Maximum comfort and control with the rubber grip. Contains a minimum of 52% recycled material. Refillable. 0.7 mm. Colours: **A** Black, **B** Red, **C** Blue.

ORDER NUMBER	DESCRIPTION	UNIT
BLN15BP-__	Specify colour	EA

B UNI® IMPACT METALLIC GEL PENS

Bold, vivid, brilliant colours. Perfect for crafts and bullet journaling. 1.0 mm.



ORDER NUMBER	DESCRIPTION	UNIT
1 70201C	Blue, Violet and Pink	3/PK
2 1919997C	Gold, Silver and White	3/PK



D PENTEL® ENERGEL® LIQUID GEL INK PEN

Designed with left handed writers in mind. Quick drying, acid free ink. Contains a minimum of 54% post-consumer recycled material. Latex free comfort grip for fatigue free writing. Refillable. 0.7 mm Colours: **A** Black, **B** Red, **C** Blue. 1.0 mm Colours: **A** Black, **C** Blue.

ORDER NUMBER	DESCRIPTION	UNIT
1 BL57-__	0.7 mm, specify colour	EA
2 BL60-__	1.0 mm, specify colour	EA



F ZEBRA JIMMIE GEL® ROLLERBALL PEN

Acid free, archival ink system; smooth ink flow. Soft rubber grip; refillable. Medium 0.7 mm point, colours: **10** Black, **20** Blue.

ORDER NUMBER	DESCRIPTION	UNIT
45888-441__	Specify colour	EA



H UNI® 207™ IMPACT GEL PEN

Uses specially formulated uni Super Ink™ that fuses to paper, preventing criminal cheque washing and other fraud. Fade proof and water resistant for archive quality that's bright and vibrant. Rubber grip for extra comfort. Visible ink supply. Bold point, 1.0 mm.

ORDER NUMBER	DESCRIPTION	UNIT
1 65800	Black	EA
2 65801	Blue	EA

uni FEATURE

NEW!

A UNI® ERASABLE GEL PENS

Writes like a gel pen, erases like a pencil. Innovative thermo-sensitive gel ink formula cleanly erases with no residue. 0.7mm.

ORDER NUMBER	DESCRIPTION	UNIT
1 90148	Blue	EA
2 90149	Black	EA
3 90150	Assorted Fashion Colours	4/PK
4 90151	Assorted Business Colours	4/PK

STICK PENS

5 90161	Blue	EA
6 90162	Black	EA
7 90164	Assorted Fashion Colours	4/PK
8 90163	Assorted Business Colours	4/PK



B PILOT® FRIXION ERASABLE GEL PENS

Thermo-sensitive gel ink disappears with friction. 0.5mm Needle Point Colours: **BK** Black, **BE** Blue, **RD** Red, **PE** Purple.

0.7mm Medium Point Colours: **AO** Apricot, **BE** Blue, **BK** Black, **CP** Coral Pink, **GN** Green, **LP** Light Purple, **PE** Purple, **PK** Pink, **RD** Red, **SK** Sky Blue, **TE** Turquoise, **WR** Wine Red.



ORDER NUMBER	DESCRIPTION	UNIT
1 BL-FRP5-__	0.5 mm needle point, specify colour	EA
2 BL-FR7-__	0.7 mm medium point, specify colour	EA
3 BLFR7ASTC-S6	0.7 mm medium point, set of 6 colours	ST

NEW!



C PILOT® FRIXION CLICKER RETRACTABLE ERASABLE GEL ROLLER PEN

Retractable refillable gel pen with thermo-sensitive ink, removable by friction with eraser on top plug. Colours: **BK** Black, **BE** Blue, **GN** Green, **PE** Purple, **RD** Red, **TE** Turquoise. Set includes Purple, Turquoise, Pink and Blue.

ORDER NUMBER	DESCRIPTION	UNIT
1 BLRT-FR5-__	0.5 mm, specify colour	EA
2 BLFRT5P-S4	0.5 mm, set of four	4/ST
3 BLRT-FR7-__	0.7 mm, specify colour	EA
4 BLFRT7P-S4	0.7 mm, set of four	4/ST

D PILOT® FRIXION FINELINER MARKERS

Unique marker pen combines the popular Fineliner® and the FriXion pen. Erasable water-based ink offers a smooth stroke that requires no writing pressure. Ideal for writing and drawing. The ink becomes invisible with erasing friction from the rubber tip on the cap. Not suitable for legal documents. Fine tip. Colours: **BK** Black, **BE** Blue, **RD** Red, **PE** Purple.

ORDER NUMBER	DESCRIPTION	UNIT
1 SWFF-__	Specify colour	EA
2 FFAT4-R	Assorted colours	4/PK



E PILOT® VBALL® GRIP ROLLER PENS

Advanced ink feed system and visible ink supply. Corrugated rubber grip. Specify colours: **BK** Black, **BE** Blue.

ORDER NUMBER	DESCRIPTION	UNIT
1 BLN-VBG5-__	0.5mm, specify colour	EA
2 BLN-VBG7-__	0.7mm, specify colour	EA



G SCHNEIDER ONE BUSINESS ROLLER PENS

Ultra-smooth tip for the best writing experience. Super-flow-system for consistent ink flow. Cap-off ink does not run dry if removed for 2 to 3 days. Waterproof. Rubberized grip.

ORDER NUMBER	DESCRIPTION	UNIT
1 RS78301	Black	EA
2 RS78303	Blue	EA



H SCHNEIDER ONE HYBRID N ROLLER PENS

Hybrid needle tip for pleasantly soft writing. Super-flow-system for consistent ink flow. Cap-off ink does not run dry if removed for 2 to 3 days. Waterproof. Rubberized grip. 0.5 mm.

ORDER NUMBER	DESCRIPTION	UNIT
1 RS78341	Black	EA
2 RS78343	Blue	EA



F PILOT® FRIXION ERASABLE COLOURING MARKERS

Erasable markers for marking or colouring. Easy to use, safe for children – no residue no odour. With 2.5 mm polyester fibre tips.

ORDER NUMBER	DESCRIPTION	UNIT
1 SW-FC-S6	6 colours	ST
2 SW-FC-S12	12 colours	ST

Writing – roller pens



A UNI® VISION NEEDLE™ ROLLER PENS

Writes with precision. Uni Super Ink™ protects against water, fading and fraud. Visible ink level barrel. 0.5 mm.

ORDER NUMBER	DESCRIPTION	UNIT
1 1734918	Black	EA
2 1734919	Blue	EA
3 1734916C	Assorted fashion colours	8/PK



C SHARPIE® ROLLER PEN

Premium metal clip and a translucent grip that indicates ink colour. Needle tip for the ultimate writing precision. 0.5mm.

ORDER NUMBER	DESCRIPTION	UNIT
1 2093225	Black	EA
2 2093199	Blue	EA
3 2093226	Red	EA



E UNI® VISION ELITE™ ROLLER PEN

Features a sleek, modern body with silky-smooth, free-flowing ink. uni Super Ink™ technology protects against water, fading, & fraud. Featuring a tungsten carbide rollerball, this pen is designed to withstand rapid pressure changes, making it ideal for frequent flyers.

ORDER NUMBER	DESCRIPTION	UNIT
1 69000	0.5 mm, Black	EA
2 69021	0.5 mm, Blue	EA
3 61231	0.8 mm, Black	EA
4 61232	0.8 mm, Blue/Black	EA



G UNI® ROLLER™ PEN

Crafted with 80% post-consumer recycled electronics. Delivers the silky-smooth glide of a fountain pen without smudging. uni Super Ink™ technology protects against water, fading & fraud. Fine point 0.7mm colours: **1** Black, **2** Red, **3** Blue. Micro point 0.5mm colours: **1** Black, **2** Red, **3** Blue, **4** Green.

**BUY MORE
SAVE MORE**

ORDER NUMBER	DESCRIPTION	UNIT	1-11	12
1 6010	Fine point, specify colour	EA		
2 6015	Micro point, specify colour	EA		



I UNI® DELUXE™ ROLLER PEN

Deluxe's gleaming, brushed-steel exterior writes in style. uni Super Ink™ technology protects against water, fading & fraud. Micro point colours: **25** Black, **27** Blue. Fine point colours: **52** Black, **53** Blue.

ORDER NUMBER	DESCRIPTION	UNIT
600	Specify point/colour	EA



B PILOT® HI-TECPOINT PEN

Transparent viewing area in the barrel shows water soluble ink in a jumbo reservoir. 0.5 mm Colours: **BE** Blue, **BK** Black, **GN** Green, **PE** Purple, **PK** Pink, **RD** Red, **TE** Turquoise, **BB** Blue Black, **DR** Dark Red, **LG** Light Green, **OR** Orange. 0.7 mm Colours: **BE** Blue, **BK** Black, **GN** Green, **RD** Red.

**BUY MORE
SAVE MORE**

ORDER NUMBER	DESCRIPTION	UNIT	1-11	12
1 BXV5-	0.5mm, specify colour	EA		
2 BXV7-	0.7mm, specify colour	EA		



D PILOT® HI-TECPOINT V5/V7 GRIP PEN

Stainless steel pipe with cemented carbide alloy ball and a non-slip rubber grip. Colours: **BK** Black, **BE** Blue, **RD** Red.

**BUY MORE
SAVE MORE**

ORDER NUMBER	DESCRIPTION	UNIT	1-11	12
1 BXGPN-V5-	0.5 mm, specify colour	EA		
2 BXGPN-V7-	0.7 mm, specify colour	EA		



F PILOT® HI-TECPOINT RT

Needle point rollerball produces effortless, pure, clean lines. Retractable and refillable. Comfortable rubber grip. 0.5mm Colours: **BK** Black, **BE** Blue, **BB** Blue Black, **GN** Green, **RD** Red, **DR** Dark Red, **OR** Orange, **PE** Purple. 0.7mm Colours: **BK** Black, **BE** Blue, **RD** Red.

ORDER NUMBER	DESCRIPTION	UNIT
1 BXRT-V5-	0.5 mm, specify colour	EA
2 BXRT-V7-	0.7 mm, specify colour	EA



H UNI® VISION™ ROLLER PEN

Viewable ink window, uni Super Ink™ which protects against water, fading and fraud. Colour-coded cap end.

0.38mm Colours: **31** Black, **32** Blue, **33** Red.

0.5mm Colours: **06** Black, **08** Blue, **17** Red.

0.7mm Colours: **126** Black, **134** Blue, **139** Red, **386** Green, **382** Purple.

1.0mm Colours: **28** Black, **29** Blue, **30** Red.

**BUY MORE
SAVE MORE**

ORDER NUMBER	DESCRIPTION	UNIT	1-11	12
1 701	0.38 mm, specify colour	EA		
2 601	0.5 mm, specify colour	EA		
3 60	0.7 mm, specify colour	EA		
4 701	1.0 mm, specify colour	EA		



J UNI® ONYX™ PEN

Onyx is crafted with 73% post-consumer recycled electronics. Delivers the silky-smooth glide of a fountain pen without smudging. uni Super Ink™ technology protects against water, fading, & fraud. Micro (0.5mm) point colours: **0** Black, **1** Blue, **2** Red. Fine (0.7mm) point colours: **3** Black, **5** Blue.

ORDER NUMBER	DESCRIPTION	UNIT
1 6004	0.5mm, specify colour	12/BX
2 6014	0.7mm, specify colour	12/BX

Writing – executive pens



A PENTEL® ENERCEL® GEL PENS

High performance ink technology combines the best qualities of liquid and gel for a super-smooth writing experience. Dries fast, no smears, no smudges, no globs. Includes gift box. Refillable. 0.7 mm. Black ink.

ORDER NUMBER	DESCRIPTION	UNIT
1 BL2007A-AE1	Black barrel	EA
2 BL2007S-AE1	Sky blue barrel	EA
3 BL2007Z-AE1	Silver barrel	EA



C PENTEL® STERLING GEL PENS

Slick and elegant design. All metal barrel and cap. Glossy lacquered barrel with chrome engraved ring. Includes gift box. Refillable. 0.7 mm. Black ink.

ORDER NUMBER	DESCRIPTION	UNIT
1 K611A-LR7AE1	Black barrel	EA
2 K600-LR7AE1	Silver barrel	EA
3 K611V-LR7AE1	Violet barrel	EA



E PILOT® DR. GRIP® FROSTED RETRACTABLE GEL PEN

Only Dr. Grip has Pilot's smooth writing gel ink, unique comfortable rubber grip and barrel design. Features incredible writing comfort in a new, lighter weight barrel. Ultra smooth writing advanced ink. Refillable. Blue barrel with black ink. Medium point.

ORDER NUMBER	UNIT
GRP-FRST	EA



G ZEBRA SARASA™ GRAND EXECUTIVE RETRACTABLE GEL PENS

Rapid dry ink and robust spring loaded clip. Steel barrel design.

ORDER NUMBER	DESCRIPTION	UNIT
1 45888-45111	Black barrel, Black ink	EA
2 45888-45211	Navy barrel, Blue ink	EA
3 45888-45511	Gold barrel, Black ink	EA



B PENTEL® ENERCEL® ALLOY RT RETRACTABLE GEL PEN

Retractable liquid gel roller with sleek, balanced brushed aluminum alloy barrel and chrome accents. Textured grip; quick-drying liquid/gel blend ink; 0.7 mm medium metal tip. Black ink unless otherwise specified.

ORDER NUMBER	DESCRIPTION	UNIT
1 BL407-A	Silver barrel	EA
2 BL407A-A	Black barrel	EA
3 BL407P-A	Pink barrel	EA
4 BL407V-V	Violet barrel / Violet ink	EA
5 BL407X-A	Gold barrel	EA
6 BL407LS-A	Aqua barrel	EA



D ZEBRA X-701 EXTREME RETRACTABLE BALL POINT PEN

Writes in extreme hot or cold temperatures. Black matte finish barrel. lanyard loop for portability. Refillable. Medium.

ORDER NUMBER	DESCRIPTION	UNIT
1 45888-29811	Black barrel	EA
2 45888-85210	Medium Black refill NEW!	EA



NEW!

F CROSS® CALAIS BALLPOINT PEN

Calais is the ultimate in sophistication. Wider than your average Cross silhouette, this ergonomic writing instrument will give you a firm grip on all you want to achieve. Gift boxed.

ORDER NUMBER	DESCRIPTION	UNIT
1 AT0112-1	Polished Chrome barrel	EA
2 AT0112-14	Matte Black barrel	EA



H ZEBRA F-701 ALL METAL BALLPOINT PEN

Features a designer stainless steel tip, barrel and clip and a knurled metal grip for writing confidence. Refillable with premium F refill. Stainless Steel – from tip to clip including an all metal ring and refill. Fine point, black ink.

ORDER NUMBER	DESCRIPTION	UNIT
45888-29411	Stainless steel	EA

Check online for the most current price.

285

Writing – stylus and fountain pens



A ZEBRA Z-1000 2-IN-1 UNIVERSAL TOUCHSCREEN STYLUS PEN

When stylus is not needed, the cap fits over it and the Z-1000 functions as a premium pen, with a smooth, low viscosity ball point ink which provides effortless writing. Black ink; 1.0 mm medium point. Barrel colours: **0** White, **1** Black, **2** Blue, **3** Red.

ORDER NUMBER	DESCRIPTION	UNIT
1 45888-332_1	Specify barrel colour	EA
2 45888-86112	Medium black refill	2/CD



C PAPER MATE® INKJOY® 2-IN-1 STYLUS PEN

Multi-task between paper and digital work. Silicone stylus tip for precise digital writing. Triangular barrel for optimal writing fit. 1.0 mm. Blue.

ORDER NUMBER	UNIT
1951349	EA



E PILOT® G2 PEN STYLUS

The stylus tip is soft yet durable at the same time. Premium G2 gel writing which is retractable and refillable. Medium black.

ORDER NUMBER	UNIT
G27LSTL	EA



G ZEBRA ZENSATIONS™ FOUNTAIN PEN

Innovative ink system with no cartridge to refill. Stainless steel nib 0.6 mm.

ORDER NUMBER	DESCRIPTION	UNIT
1 45888-48310	Black	EA
2 45888-48320	Blue	EA
3 45888-04007	Assorted	7/PK



B ZEBRA TELESCOPIC STYLUS PEN

2-in-1 universal stylus and ballpoint pen. Zebra Pen's most sleek and stylish StylusPen option. Extends to full length when writing and easily retracts to shorter length making it perfect for pockets, purses, laptop backs and brief cases. 1.0mm ball point with ultra smooth ink performance. Black ink.

ORDER NUMBER	DESCRIPTION	UNIT
1 45888-33641	Lime green	CD
2 45888-33661	Light blue	CD



D PENTEL® R.S.V.P.® STYLUS BALLPOINT PENS

Pen and stylus in one. Works on all capacitive screen devices. Transparent barrel displays ink level. Rubber Comfort Zone™ grip with dimpled finger grips. Refillable. Medium point.

ORDER NUMBER	DESCRIPTION	UNIT
1 BK90LBP2-A	Black	2/PK
2 BK90LBP2-C	Blue	2/PK



F PILOT® DISPOSABLE FOUNTAIN PEN

Writes a crisp, clean fine line. Visible ink supply.

ORDER NUMBER	DESCRIPTION	UNIT
1 SVP-4M-BK	Black	EA
2 SVP-4M-BE	Blue	EA



NEW!



A MERANGUE® SIZEIT™ BALLPOINT PEN REFILL

Sizeit™ refill with spring. Cut to size. Fits most ballpoint pens.

ORDER NUMBER	DESCRIPTION	UNIT
3872-4121-20-000	Black	2/PK



C CROSS® BALLPOINT PEN REFILLS

Medium point: **1** Blue, **3** Black. Fine point: **2** Blue, **4** Black.

ORDER NUMBER	DESCRIPTION	UNIT
851_-2	Specify point and colour	2/CD



E CROSS® ROLLING WRITER REFILLS

ORDER NUMBER	DESCRIPTION	UNIT
1 8521	Medium point, Blue	CD
2 8523	Medium point, Black	CD



G MERANGUE® REFILLS FOR CROSS BALLPOINT PENS

ORDER NUMBER	DESCRIPTION	UNIT
1 3872-4111-20-000	Medium point, Black	2/PK
2 3872-4111-50-000	Medium point, Blue	2/PK



I PARKER® QUINKFLOW REFILLS

Ballpoint refill 1 per card. Fine point: **67** Black, **68** Blue
Medium point: **69** Black, **71** Blue.

ORDER NUMBER	DESCRIPTION	UNIT
19503__	Specify point and colour	CD



K PENTEL® R.S.V.P.® PEN REFILLS

For BK77, BK90

ORDER NUMBER	DESCRIPTION	UNIT
1 BKL7-A	Fine point, Black	2/PK
2 BKL7-C	Fine point, Blue	2/PK



M PILOT® ACROBALL® BALL POINT REFILLS

ORDER NUMBER	DESCRIPTION	UNIT
1 BRFV-10M-BK	Medium point, Black	EA
2 BRFV-10M-BE	Medium point, Blue	EA



B MERANGUE® REFILLS FOR PARKER PENS

ORDER NUMBER	DESCRIPTION	UNIT
1 3872-4081-20-000	Medium point, Black	2/PK
2 3872-4081-50-000	Medium point, Blue	2/PK



D PARKER® BALL PEN GEL REFILLS

ORDER NUMBER	DESCRIPTION	UNIT
1 1950362	Medium point, Black	2/CD
2 1950364	Medium point, Blue	2/CD



F PARKER® ROLLER BALL REFILLS

ORDER NUMBER	DESCRIPTION	UNIT
1 1950323	Medium point, Black	CD
2 1950324	Medium point, Blue	CD



H PARKER® QUINK® CARTRIDGES

ORDER NUMBER	DESCRIPTION	UNIT
1 1950402	Permanent Black	5/CD
2 1950208	Washable Blue	5/CD



J PENTEL® ENERGEL® RETRACTABLE GEL REFILLS

Colours: **A** Black, **B** Red, **C** Blue, **D** Green, **V** Violet

ORDER NUMBER	DESCRIPTION	UNIT
1 LR7-__	0.7 mm, specify colour	EA
2 LRN5-__	0.5 mm needle tip, specify colour	EA



L PENTEL® ENERGEL® REFILLS

For BLC35W Multi-Function Gel Roller.

ORDER NUMBER	DESCRIPTION	UNIT
1 LRN5H-A	0.5mm, Black	EA
2 LRN5H-C	0.5mm, Blue	EA
3 LRN5H-B	0.5mm, Red	EA

N PILOT® BALLPOINT PEN REFILLS

For: BP145, BPB2P, Supergrip, Rexgrip.

ORDER NUMBER	DESCRIPTION	UNIT
1 RMB	Medium point, Black	2/CD
2 RME	Medium point, Blue	2/CD
3 RFB	Fine point, Black	2/CD
4 RFE	Fine point, Blue	2/CD



A PILOT® FOUNTAIN PEN CARTRIDGES

Colours: **BK** Black, **BE** Blue.

ORDER NUMBER	DESCRIPTION	UNIT
IC50-__	Specify colour	6/BX



C PILOT® HI-TECPOINT RETRACTABLE PEN REFILLS

Colours: **B** Black, **L** Blue, **R** Red.

ORDER NUMBER	DESCRIPTION	UNIT
1 VR5R_	0.5 mm, specify colour	2/CD
2 VR7R_	0.7 mm, specify colour	2/CD



E SHEAFFER® BALLPOINT REFILL

Fine point: **24** Blue, **34** Black. Medium point: **25** Blue, **35** Black.

ORDER NUMBER	DESCRIPTION	UNIT
74040-993_	Specify colour	CD



NEW!

G UNI® ERASABLE PEN REFILLS

Colours: **1** Blue/Black, **2** Blue, **3** Jet Black.

ORDER NUMBER	DESCRIPTION	UNIT
1 90139	0.7mm, Black	3/PK
2 90140	0.7mm, Blue	3/PK



I UNIBALL® 207™ RETRACTABLE GEL PEN REFILLS

ORDER NUMBER	DESCRIPTION	UNIT
1 70207PP	Black, 0.7 mm	2/CD
2 71207PP	Blue, 0.7 mm	2/CD



K UNI® JETSTREAM™ RETRACTABLE PEN REFILLS

ORDER NUMBER	DESCRIPTION	UNIT
1 35972	Bold point, Black	2/PK
2 35973	Bold point, Blue	2/PK



M UNI® 207 PLUS® GEL REFILLS

ORDER NUMBER	DESCRIPTION	UNIT
1 70161	0.7mm, Black	2/PK
2 70162	0.7mm, Blue	2/PK



B PILOT® GEL REFILLS

For G2, G2 Stylus, B2P, Mid Range rolling ball and Dr. Grip Ltd.

ORDER NUMBER	DESCRIPTION	UNIT
1 G25RB	0.5 mm, Black	2/CD
2 G27RB	0.7 mm, Black	2/CD
3 G27RL	0.7 mm, Blue	2/CD



D PILOT® FRIXION™ BALL AND FRIXION BALL CLICKER ERASABLE INK REFILLS

Colours: **B** Black, **L** Blue, **R** Red, **V** Violet.

ORDER NUMBER	DESCRIPTION	UNIT
1 FR5R_2	0.5 mm Roller Ball	2/CD
2 FR7R_2	0.7 mm Roller Ball	2/CD
3 FRP5R_2	0.5 mm Needle Point (Black, Blue or Red only)	2/CD

NEW!

F SHEAFFER® INK CARTRIDGES

Colours: **1** Blue/Black, **2** Blue, **3** Jet Black.

ORDER NUMBER	DESCRIPTION	UNIT
1 74040-963_0	Specify colour	5/CD
2 74040-96400	Set: black, blue, red, green, purple	5/CD



H ZEBRA F-301 BALLPOINT PEN REFILLS

Colours: **10** Black, **20** Blue.

ORDER NUMBER	DESCRIPTION	UNIT
45888-855_	Fine point, specify colour	EA



J ZEBRA GEL PEN REFILLS

Rapid dry ink. For: Sarasa, Sarasa SE and GR8.

ORDER NUMBER	DESCRIPTION	UNIT
1 45888-87012	JF-Refill Black, 0.7 mm	2/CD
2 45888-87022	JF-Refill Blue, 0.7 mm	2/CD



L ZEBRA JIMMIE® GEL PEN REFILLS

ORDER NUMBER	DESCRIPTION	UNIT
1 45888-84310	J-Refill, 0.7 mm, Black	EA
2 45888-84320	J-Refill, 0.7 mm, Blue	EA



N ZEBRA TELESCOPIC BALLPOINT REFILLS

ORDER NUMBER	DESCRIPTION	UNIT
45888-84412	T-Refill Black, medium point	2/CD



A PILOT™ BEGREEN WHITE LINE RT RETRACTABLE CORRECTION TAPE

With 88% recycled content. 4 mm×6 m.

ORDER NUMBER	DESCRIPTION	UNIT
1 CTRT4G-BG	Refillable dispenser	EA
2 CRTR4GR-BG	Refill	2/CD



C BIC® WITE-OUT® EZ CORRECT® CORRECTION TAPE

Film-based tape, stronger than paper based tape. New tip with side guards to keep it on track. Tape length: 12 m.

ORDER NUMBER	DESCRIPTION	UNIT
1 70330-50523	Disposable	EA
2 70330-51249	Disposable	3/PK
3 70330-50790	Disposable	10/BX



E BIC® WITE-OUT® EZ CORRECT® GRIP CORRECTION TAPE

Strong, tear resistant film-based tape; soft latex free grip. Tape dimensions: 4.2 mm×10.2 m.

ORDER NUMBER	DESCRIPTION	UNIT
70330-51601	Disposable	EA



G TOMBOW MONO ORIGINAL CORRECTION TAPE

Easy to use side-action applicator for accurate application. Dual gear technology prevents looping. Flexible pivoting tip. Contains a minimum of 70% post-consumer recycled material. Nonrefillable. Covers 1 line. 4.2 mm×10 m (394").



ORDER NUMBER	DESCRIPTION	UNIT
68627	Disposable	2/PK

Our Brand, YOUR Savings!



B OP BRAND CORRECTION TAPE

For instant, clean correction. Swivel head allows left-handed or right-handed use. Covers one line; non-refillable; 5 mm×8 m (315").

ORDER NUMBER	DESCRIPTION	UNIT
27811-50035	Disposable	EA



D BIC® WITE-OUT® REVOLUTION™ CORRECTION TAPE

The film is made with 56% recycled plastic and the paperboard used in this packaging is made up of 100% recycled content. Strong tear-resistant tape dries instantly so you can write over it immediately. Covers 1 line. 5 mm×6 m.



ORDER NUMBER	DESCRIPTION	UNIT
1 70330-53721	Disposable	2/PK
2 70330-53722	Disposable	10/BX



F DIXON® CORRECTION TAPE

Flexible tip for smooth application. Contoured design provides a comfortable hold for fast application and no drying time. Side application improves visibility. Non-refillable. Covers 1 line. 5 mm×8 m (315").

ORDER NUMBER	DESCRIPTION	UNIT
72067-31930	Disposable	10/BX



H PRITT™ CORRECT-IT™ NON-REFILLABLE DRY CORRECTION ROLLER

A quick, clean and accurate way to make corrections. No odour, no mess, no shadow on photocopies. Tape dimensions: 4.2 mm×8.5 m.

ORDER NUMBER	DESCRIPTION	UNIT
61083-63989	Disposable	CD



**A TOMBOW
TOMBOW MONO MINI CORRECTION TAPE**

Single line correction tape in a transparent applicator pinpoints and corrects mistakes quickly, cleanly and completely. Compact size for backpacks, planners, etc. Non-refillable. 4.2mm X 8m (315").

ORDER NUMBER	DESCRIPTION	UNIT
68722	Disposable	10/PK



**C BIC® WITE-OUT®
EXACT LINER® CORRECTION TAPE**

Combines the feel of a pen with the benefits of a correction film. Corrects mistakes instantly with no drying time. Film-based tape - stronger than paper based tape. Thinner for better laydown. 5mm x 6m.

ORDER NUMBER	DESCRIPTION	UNIT
70330-50743	Disposable	CD

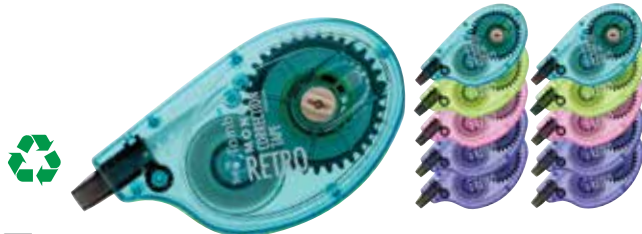

**B TOMBOW
MONO RETRO CORRECTION TAPE**

Easy to use side-action applicator gives accurate application. Dual gear technology prevents looping. Flexible pivoting tip. Contains a minimum of 70% post-consumer recycled material. Non-refillable. Covers 1 line. 4.2 mm×10 m (394"). Assorted Aqua, Kiwi, Rose and Lavender.

ORDER NUMBER	DESCRIPTION	UNIT
68723	Disposable	10/PK



**D PAPER MATE®
LIQUID PAPER® DRYLINE®
GRIP CORRECTION TAPE**

Easy to use cover-up film goes on dry in single typing line width. 5 mm×8.5 m.



ORDER NUMBER	DESCRIPTION	UNIT
1 660415	Disposable	CD
2 6915617	Disposable	3/PK
3 6612	Disposable	12/BX

**E POST-IT®
CORRECTION TAPE**

Removable cover up tape. Photocopy documents and mask certain areas without damaging the original when you remove the tape.

ORDER NUMBER	DESCRIPTION	UNIT
658	1", 6 lines	RL



**G PENTEL®
CORRECTION PEN**

Flat style flexible barrel; fine tip. Application can be adjusted by finger pressure on the barrel.

ORDER NUMBER	DESCRIPTION	UNIT
ZL31-W	Flat, 12 ml	EA



**F TOMBOW
MONO AIR
CORRECTION TAPE**

Pivoting head and tape lock system automatically stops tape and provides a smooth, skip-free application. Non-refillable. Covers 1 line. 6 mm×10 m (394").

ORDER NUMBER	DESCRIPTION	UNIT
68695	Disposable	EA



NEW!

**H BIC® WITE-OUT®
SHAKE 'N SQUEEZE
CORRECTION PEN**

Soft squeeze barrel for maximum fluid control. Needlepoint tip. 8 mL. White.

ORDER NUMBER	DESCRIPTION	UNIT
70330-50695	Disposable	2/PK



NEW!

**I BIC® WITE-OUT
QUICK DRY
CORRECTION FLUID**

Foam applicator for precision and outstanding coverage. Strokes on easily, then dries fast. 22 ml.

ORDER NUMBER	DESCRIPTION	UNIT
1 70330-50603		3/PK
2 70330-50605		12/BX



**I DIXON®
CORRECTION FLUID**

Universal correction fluid in a convenient 20 ml bottle. Provides superior coverage, no strong odours, won't deplete the ozone layer and requires no thinners. Brush applicator.

ORDER NUMBER	DESCRIPTION	UNIT
72067-31900		EA



Our Brand, YOUR Savings!



A OP BRAND HIGHLIGHTER

Chisel tip. Colours: **08** Pink, **09** Yellow.

ORDER NUMBER	DESCRIPTION	UNIT
27811-500	Specify colour	12/BX



C STAEDTLER® TEXTSURFER CLASSIC HIGHLIGHTER

Features odourless, waterbased pigment ink that won't bleed through. Inkjet safe. Chisel tip. Colours: **1** Yellow, **3** Blue, **4** Orange, **5** Green, **23** Pink.



ORDER NUMBER	DESCRIPTION	UNIT
1 364	Specify colour	EA
2 364 SC4	Set of 4 colours	ST



E SCHNEIDER JOB PASTEL HIGHLIGHTERS

Light-resistant ink with intensive colour can be used on standard, copy and fax paper. Barrel parts made from anti-evaporation polypropylene for long-term shelf-life. Cap with practical clip. Chisel tip. Assorted Pastel colours.

ORDER NUMBER	UNIT
RS115097	6/PK



F BEROL® HIGHLIGHTERS

For use on regular bond paper. Anti-roll cap design. Textured barrel. Colours: **4** Yellow, **7** Pink.

ORDER NUMBER	DESCRIPTION	UNIT
6432	Specify colour	EA



B HI-LITER® BRAND HIGHLIGHTER

Quick dry, non-toxic. Chisel tip won't fray or "mush". Colours: **3** Blue, **4** Green, **6** Orange, **7** Yellow, **9** Pink. PVC free barrel.

ORDER NUMBER	DESCRIPTION	UNIT	1-11	12
1 67933-8350	Specify colour	EA		
2 71709-24060	Purple	EA		
3 71709-78881	Assorted colours	12/PK		
4 67933-83564	Yellow, Green, Blue, Pink	4/CD		

BUY MORE SAVE MORE



D SHARPIE® TANK HIGHLIGHTER

Chisel tip. Large ink supply. Quick drying, odourless. Colours: **06** Fluorescent Orange, **09** Fluorescent Pink, **10** Blue, **25** Fluorescent Yellow, **26** Fluorescent Green.

ORDER NUMBER	DESCRIPTION	UNIT	1-11	12
1 250	Specify colour	EA		
2 25174PP	Fl. Yellow, Fl. Orange, Fl. Pink, Blue	5/PK		
3 1920938	Yellow	36/BX		

BUY MORE SAVE MORE



G SHARPIE® CLEAR VIEW® HIGHLIGHTER

Innovative crystal clear tip eliminates blind spots so you see exactly where your highlighter mark begins & ends. Achieve both thick and thin lines precisely where you want with 2-in-1 tip size. Clear cap with frosted edging highlights unique tip. Bold bright colours and smear guard-pigmented ink system.

ORDER NUMBER	DESCRIPTION	UNIT
1 2128227	Yellow	EA
2 2128222	Yellow, Orange, Pink	3/PK

NEW!

Writing – highlighters



A PILOT® FRIXION ERASABLE HIGHLIGHTER

Thermo-sensitive ink disappears with friction using rubber tail plug on pen, allowing repeated writing on same spot. Colours: **GN** Green, **PK** Pink, **YE** Yellow.

ORDER NUMBER	DESCRIPTION	UNIT
1 SWFL-__	Specify colour	EA
2 SWFL-S6	Set of 6 assorted colours	ST
3 SWFL-S6S	Set of 6 soft colours	ST



B SHARPIE® S-NOTE CREATIVE MARKERS

Versatile and fun, they're both a marker and a highlighter, adding a splash of colour to note-taking, underlining, highlighting, drawing and more. Features no-bleed ink in translucent colours. Chisel tip. Assorted colours.

ORDER NUMBER	UNIT
2117329	12/PK



C ZEBRA MILDLINER DOUBLE ENDED HIGHLIGHTERS

Mild, water-resistant ink is translucent and excellent for layering. Doesn't bleed through. AP certified non-toxic. Chisel and fine tip.

ORDER NUMBER	DESCRIPTION	UNIT
1 45888-78305	Assorted deep and warm colours	5/PK
2 45888-78205	Assorted cool and refined colours	5/PK
3 45888-78105	Assorted fluorescent colours	5/PK
4 45888-78405	Assorted refresh colours	5/PK
5 45888-78505	Assorted friendly colours	5/PK



D PENTEL® ILLUMINA FLEX DUAL TIP HIGHLIGHTER

Great combination for highlighting, underlining and colour coding. Dual tipped with fine and chisel tips. Soft colour.

ORDER NUMBER	DESCRIPTION	UNIT
SLW11P-G	Pastel Yellow	EA
SLW11P-8	Assorted pastels	8/PK



F PILOT® SPOTLITER® HIGHLIGHTER

Fluorescent ink. In pocket style with cap and clip. Convenient pen size. Chisel point. Colours: **BE** Blue, **GN** Green, **OR** Orange, **PE** Purple, **PK** Pink, **YE** Yellow.

ORDER NUMBER	DESCRIPTION	UNIT
1 SWSL-__	Specify colour	EA
2 SWSL-S6	Set of 6 colours	ST



E ZEBRA KIRARICH™ GLITTER HIGHLIGHTERS

Unique glitter highlighter is translucent and filled with shimmer. Water resistant. Chisel tip. Assorted colours.

ORDER NUMBER	UNIT
45888-71605	5/PK

A AVERY® PEN STYLE HI-LITER®

The Original™ highlighter in vibrant fluorescent colours. Compact and portable design. Molded tip won't fray or mush. Non toxic, ACMI certified; PVC free. Sturdy clip for pocket, organizer or binder. Chisel tip. 3 Pack of Yellow, Pink and Blue.



ORDER NUMBER	UNIT
67933-24091	3/PK



B SHARPIE® RT RETRACTABLE HIGHLIGHTER

Features Safety Seal™ technology that prevents dry-out and eliminates cap loss. Smear Guard™ ink; chisel tip.

ORDER NUMBER	DESCRIPTION	UNIT
1 28025	Yellow	EA
2 28029	Pink	EA



C SHARPIE® LIQUID HIGHLIGHTER

Visible ink supply; fluorescent, water resistant ink that will not fade. Quick drying odourless ink is non-toxic. Colours: **3** Yellow, **4** Pink, **6** Orange, **7** Blue, **8** Green, **9** Purple.

ORDER NUMBER	DESCRIPTION	UNIT
1 175446	Specify colour	EA
2 24575PP	Set of 5, colours: orange, blue, yellow, green, pink	ST
3 24415PP	10 vivid colours, carded	ST



D SHARPIE® POCKET HIGHLIGHTER

Micro chisel tip. Fluorescent. Colours: **06** Orange, **09** Pink, **25** Yellow, **26** Green.

ORDER NUMBER	DESCRIPTION	UNIT	1-11	12
1 270	Specify colour	EA		
2 27174PP	Set of 4 fluorescent colours: Yellow, Orange, Pink, Blue	ST		
3 2003991	Yellow	36/BX		NEW!



E BIC® BRITE LINER® HIGHLIGHTER

Chisel tip for broad-line highlighting or fine line underlining. Won't dry out when the cap is left off for 8 hours.

ORDER NUMBER	DESCRIPTION	UNIT
1 70330-90837	Set of 5 assorted colours	PK
2 70330-65550	Yellow	12/BX
3 70330-34128	Assorted colours	24/BX



F BIC® BRITE LINER® GRIP HIGHLIGHTER

Ideal for either broad or fine line highlighting. Wide profile; comfort grip; chisel tip. Won't dry out when the cap is left off for 8 hours. Assorted pastels.

ORDER NUMBER	UNIT
1 70330-36411	6/PK
2 70330-36466	12/PK

Our Brand, YOUR Savings!



A OP BRAND FINE POINT PERMANENT MARKER

Marks on almost any surface. Waterproof and smearproof ink, non-toxic.

ORDER NUMBER	DESCRIPTION	UNIT
27811-50036	Black	12/BX



B OP BRAND CHISEL TIP PERMANENT MARKER

Marks on almost any surface. Waterproof and smearproof ink, non-toxic.

ORDER NUMBER	DESCRIPTION	UNIT
27811-50002	Black	10/BX



C SHARPIE® FINE POINT MARKERS

Permanent ink marker writes on many surfaces including paper, glass, plastic and tape. Highly water resistant. Dries quickly. Fine point bulk colours: **01** Black, **02** Red, **03** Blue, **04** Green, **06** Orange, **08** Purple, **35** Yellow, **37** Brown.



ORDER NUMBER	DESCRIPTION	UNIT	1-11	12
1 300_	Specify colour	EA		
2 30162PP	Black	2/CD		
3 30173PP	Black, Blue, Red	3/CD		
4 30075PP	12-colour set	CD		
5 1949557	24-colour set	CD		
6 1921559	Assorted colours	36/BX		



G SHARPIE® CHISEL TIP MARKERS

Anti-roll barrel design. Permanent on most surfaces. Fade and water-resistant ink is quick-drying and is AP certified non-toxic. Chisel tip. Colours: **1** Black, **2** Red, **3** Blue.



ORDER NUMBER	DESCRIPTION	UNIT	1-11	12
1 3820_	Specify colour	EA		
2 38262PP	Black	2/CD		
3 38254PP	Black, Blue, Red, Green	4/CD		



D SHARPIE® RETRACTABLE MARKERS

Same great Sharpie® ink, now in a retractable marker that allows one-handed operation. Fine point colours: **1** Black, **2** Red, **3** Blue.

ORDER NUMBER	DESCRIPTION	UNIT
1 3270_	Fine point, specify colour	EA
2 1735790	Ultra fine point, Black	EA
3 32726PP	Fine point, Assorted	3/PK

E SHARPIE® PERMANENT MARKERS VALUE PACK

Variety pack features 6 markers in 3 different tip sizes: a fine point, an ultra-fine point, and a chisel tip for both thin and thick lines. Permanent. Black.



ORDER NUMBER	DESCRIPTION	UNIT
2135318	Black marker	6/PK



F SHARPIE® TWIN TIP MARKERS

Unique! Two tips in one pen - fine and extra fine - allow you to "Mark Whatever You Want!". Dries fast and resists water. Permanent. Colours: **1** Black, **2** Red, **3** Blue.



ORDER NUMBER	DESCRIPTION	UNIT	1-11	12
1 3200_	Specify colour	EA		
2 32162PP	Black	2/CD		
3 32174PP	Black, Blue, Red, Green	4/CD		



H SUPER SHARPIE® MARKERS

Long lasting ink supply. Bold fine point. Permanent on most surfaces. Fade and water resistant, dries quickly. AP certified non-toxic ink. Colours: **1** Black, **2** Red.



ORDER NUMBER	DESCRIPTION	UNIT	1-11	12
3300_	Specify colour	EA		



A ZEBRA PM-701 HEAVY DUTY REFILLABLE PERMANENT MARKER

Features a durable stainless steel barrel. Cap-off time of 120 hours. AP certified non-toxic. Writes on metal, glass, plastic & more. Fine tip. Black.



ORDER NUMBER	DESCRIPTION	UNIT
1 45888-65111	Marker	EA
2 45888-80111	Refill	EA



D SHARPIE® LIQUID TIP™ MARKER

Features a durable felt tip and pocket clip. Marks anything, including wet and oily surfaces, and dries instantly to a waterproof finish. Aluminum barrel. Xylene-free ink. Chisel tip.



ORDER NUMBER	DESCRIPTION	UNIT	1-11	12
7073502392	Black	EA		



E DIXON® REDIMARK® MARKERS

Permanent marker in 6" metal barrel.



ORDER NUMBER	DESCRIPTION	UNIT	1-11	12
1 72067-87170	Chisel, Black	EA		
2 72067-87110	Chisel, Red	EA		



G SHARPIE® MAGNUM® MARKER

Water resistant ink dries quickly and marks wet oily surfaces. Extra-large ink supply for big projects. 5/8" (15mm) wool rib for broad, bold strokes. Xylene-free ink. Metal barrel. Permanent. Chisel tip.



ORDER NUMBER	DESCRIPTION	UNIT	1-11	12
44001	Black	EA		



Check online for the most current price.



B SHARPIE® INDUSTRIAL MARKER

Water resistant marker resists bleeding and fading under most conditions. Permanent. Fine point.



ORDER NUMBER	DESCRIPTION	UNIT	1-11	12
13601	Black	EA		



C PILOT® SUPER COLOR REFILLABLE PERMANENT MARKER

Jumbo tip marker. Quick drying water resistant permanent ink. Acrylic fibre tip.

ORDER NUMBER	DESCRIPTION	UNIT
1 SC6600-BK	Black marker	EA
2 SCRF-BK	Black refill	EA



F SHARPIE® PRO INDUSTRIAL MARKERS

Built jobsite tough. Marks on wet and oily surfaces. Durable tip stands up to wear and tear. Ribbed grip area for comfort, anti-roll barrel and break-resistant clip and lanyard loop. Permanent. Black.

ORDER NUMBER	DESCRIPTION	UNIT
1 2018501	Fine tip	EA
2 2018505	Chisel tip, Black	EA
3 2018510	XL Chisel tip, Black	EA



H SHARPIE® KING SIZE™ MARKER

Marks on wet and oily surfaces and dries instantly. Excellent for marking corrugate, wood, metal, foil, stone, plastic, leather and more. Durable plastic barrel and felt tip stand up to heavy use. Large ink supply for big projects. Water-resistant non-toxic permanent ink.

ORDER NUMBER	DESCRIPTION	UNIT
15001	Black	EA

I SHARPIE® EXTREME PERMANENT MARKER

Ideal for tough conditions across a range of surfaces. Fade resistant ink delivers up to 96 hours in ultraviolet exposure. Increased adhesion on most surfaces. Fine tip.

ORDER NUMBER	DESCRIPTION	UNIT
1927432	Black	EA



A SHARPIE® NEON MARKERS

Ultra vivid in daylight. Fluoresces under black light. Fine point. Permanent.

ORDER NUMBER	DESCRIPTION	UNIT
1860443	Neon assorted	5/PK



C STAEDTLER® LUMOCOLOR® DRY SAFE PERMANENT MARKERS

Can be left uncapped for up to two weeks without drying out! For smearproof applications on all surfaces. Low odour, non-toxic. Colours: **9** Black, **2** Red, **3** Blue.

ORDER NUMBER	DESCRIPTION	UNIT
350-__	Chisel tip, specify colour	EA



E BIC® REVOLUTION™ PERMANENT MARKERS

Won't dry out for 2 weeks if left uncapped. Barrel made from 51% recycled plastic. Bullet tip.

ORDER NUMBER	DESCRIPTION	UNIT
70330-37083	Assorted	12/PK

PILOT FEATURE



B PILOT® PERMANENT MARKERS

Five Star Quality permanent marker that writes on almost any surface, such as plastic bottles, cartons, metal, glass and plastic bags. Dries quickly and is water and fade resistant. Long cap-off performance with low odor and alcohol based xylene free ink. Colours are intense and vibrant. Acrylic fibre tip for long lasting write out. Colours: **BE** Blue, **BK** Black, **RD** Red.

ORDER NUMBER	DESCRIPTION	UNIT
1 SCA-100-__	Bullet tip, specify colour	EA
2 SCA-400-__	Chisel tip, specify colour	EA



D MARKS-A-LOT® PERMANENT MARKER

Permanent, low-odour, quick-drying, water resistant, non-toxic and smearproof ink. Bold, for high visibility; marks on any surface. Barrel is PVC free.



ORDER NUMBER	DESCRIPTION	UNIT	1-11	12
1 67933-84201	Chisel tip, black	EA		
2 67933-86211	Large size chisel tip, black	EA		



F BEROL® CHISEL TIP MARKER

Permanent marker produces fast-drying, bold, vibrant, thick or thin lines on most porous and nonporous surfaces. Certified AP nontoxic, lightfast, water-resistant and smudge-resistant ink ensures long-lasting, legible letters, symbols and signs. Durable felt tip withstands heavy writing pressure. With anti-roll cap and textured barrel.

ORDER NUMBER	DESCRIPTION	UNIT
64291	Black	EA

Writing – metallic markers and paint markers



A SHARPIE® METALLIC MARKERS

Stunning sheen stands out on both light and dark surfaces. Authentic metallic Ruby, Emerald and Sapphire finishes. Quick-drying, fade- and water-resistant ink.



ORDER NUMBER	DESCRIPTION	UNIT	1-11	12
1	1823889 Fine tip, Gold	EA		
2	39100 Fine tip, Silver	EA		
3	1823815 Fine tip Gold, Silver, Bronze	3/CD		
4	2046942 Fine tip, Gold, Silver, Bronze Ruby, Emerald & Sapphire	6/CD		
5	2089638 Chisel tip, Silver	EA		
6	2089609 Chisel tip Gold, Silver & Bronze	3/CD		
7	2089634 Chisel tip Gold, Silver, Bronze, Ruby, Emerald & Sapphire	6/CD		



D JIFFY ARTLINE® PAINT MARKERS

Quick-dry, water and fade resistant permanent ink. Marks on most surfaces, indoor and outdoor. Colours: **0** Pink, **1** Black, **2** Red, **3** Blue, **4** Green, **5** Light Blue, **6** Orange, **7** Yellow, **8** Brown, **9** Purple, **10** White, **16** Yellow green.

ORDER NUMBER	DESCRIPTION	UNIT	
EK400-__	Bullet tip (2.3mm) specify colour	EA	\$5.29



B PILOT® GOLD AND SILVER MARKERS

Metal powder pigment ink writes brilliant colours on virtually any surface permanently. Colours: **G** Gold, **S** Silver

ORDER NUMBER	DESCRIPTION	UNIT
1	SC_ Broad point, specify colour	EA
2	SC_EF Extra fine, specify colour	EA



C SHARPIE® PAINT MARKERS

Oil-based opaque paint lays down smooth and vivid on a variety of surfaces from fabric to metal. Non-toxic, quick drying, low odor, xylene free ink. Available in four tip sizes. Colours: **32** Extra Fine Gold, **33** Extra Fine Silver, **39** Fine Yellow, **43** Fine White, **44** Fine Gold, **45** Fine Silver, **54** Medium Yellow, **58** Medium White.

ORDER NUMBER	DESCRIPTION	UNIT
1	355_ Specify colour	EA
2	35568 White Bold	EA



E JIFFY ARTLINE™ LOW CORROSION PAINT MARKERS

Specialized markers used for marking stainless steel. Acrylic fibre tip, Xylene free permanent ink. Water and fade resistant. Bullet tip.

ORDER NUMBER	DESCRIPTION	UNIT
1	JK420-1 Black	EA
2	JK420-10 White	EA
3	JK420-7 Yellow	EA



F JIFFY ARTLINE® PAINT MARKERS

Quick-dry, water and fade resistant permanent ink. Marks on most surfaces, indoor and outdoor. Fast drying. Colours: **1** Black, **7** Yellow, and **10** White.

ORDER NUMBER	DESCRIPTION	UNIT
EK440-__	Fine point 1.2 mm (acrylic tip) specify colour	EA

OFFICE SUPPLIES

Check online for the most current price.

Writing – pen style markers



A PILOT® FINELINER® MARKER PEN

World-renowned for providing the ultimate experience in smooth, expressive writing. Fine point engineered from tough plastic for lasting performance. 0.3 mm writing line. Colours: **BE** Blue, **BK** Black, **RD** Red, **GN** Green.

**BUY MORE
SAVE MORE**

ORDER NUMBER	DESCRIPTION	UNIT	1-11	12
SWPP-__	Specify colour	EA		



C SHARPIE® ULTRA FINE MARKERS

Permanent ink marker writes on many surfaces including paper, glass, plastic and tape. Highly water resistant, dries quickly. Ultra fine colours: **1** Black, **2** Red, **3** Blue.

**BUY MORE
SAVE MORE**

ORDER NUMBER	DESCRIPTION	UNIT	1-11	12
1 3700_	Specify colour	EA		
2 37175PP	12-colour set	PK		
3 1949558	24-colour set	PK		



E PAPER MATE® FLAIR® MARKERS

Fast-drying water-based ink will not smear or bleed when writing.

ORDER NUMBER	DESCRIPTION	UNIT
1 1978998	Medium point, Assorted	24/PK
2 8430152	Medium point, Black	EA
3 1982365	Candy Pop Colours	6/PK
4 2125414	Bold point, Assorted	12/PK



B STAEDTLER® TWIN TIP PERMANENT MARKERS

Permanent on most surfaces including wood, paper, metal, cardboard, ceramic, canvas/cloth, plastic and more. Twin tip for fine and ultra-fine writing, colouring and drawing. Quick drying. Box made with 100% post consumer recycled PET, barrels made with 100% recycled material.



ORDER NUMBER	DESCRIPTION	UNIT
3187 TB18	Assorted	18/PK

D ZEBRA SARASA™ POROUS GEL PENS

Excellent quality water resistant ink, great for precise writing and adult colouring. 0.8 mm. Assorted Colours.



ORDER NUMBER	UNIT
45888-66102	12/PK



F PAPER MATE® FLAIR® SCENTED MARKERS

Felt tip provides bold and expressive lines. Great for editing documents and papers. 0.7mm Medium point.

ORDER NUMBER	UNIT
1 2125407	6/PK
2 2125359	12/PK
3 2125408	16/PK



With
Flair Pens,
there's no limit
to your fun.

Boost your writing FUN-FACTOR

Flair®
MEDIUM



Flair®
SCENTED
Sunday Brunch



Flair®
METALLIC
City Lights



Flair®
BOLD



STAEDTLER FEATURE



A STAEDTLER® TRIPLUS FELT TIP PENS

Ergonomic triangular barrel. Can be left uncapped for days without drying up. Water-based ink; washes out of most textiles. With clip. Assorted colours.

ORDER NUMBER	DESCRIPTION	UNIT
1 334 SB10A6	Fine tip	10/PK
2 323 SB10A6	Broad tip NEW!	10/PK



B SHARPIE® PEN®

Permanent ink won't bleed through paper. Durable and smudge resistant. Precise, consistent line width. Fine point. Colours: **3** Black, **4** Blue, **5** Red.

ORDER NUMBER	DESCRIPTION	UNIT
1 174266	Specify colour	EA
2 1742659	Black	2/PK
3 1924214	Black, Blue, Red, Green	4/PK
4 1802226	Assorted colours	12/PK



C ITOYA® DOUBLEHEADER® CALLIGRAPHY MARKER

Double-ended marker with water-soluble & acid free ink. Chisel tips, 1.5 mm and 3 mm. Colours **BK** Black, **BU** Blue, **GN** Green, **PK** Pink, **PU** Purple, **RD** Red.

ORDER NUMBER	DESCRIPTION	UNIT
1 CL-10-___	Specify colour	EA
2 CL-100	6-colour set	ST

D STAEDTLER® LUMOCOLOR® ONE FOR ALL UNIVERSAL MARKERS

Universal pen for use on almost all surfaces. Suitable for overhead projection. Can be wiped off film using damp cloth. Fast-drying, water-soluble ink.



i MEDIUM TIP, PERMANENT

ORDER NUMBER	DESCRIPTION	UNIT
1 317-9	Black	EA
2 317-3	Blue	EA
3 317-2	Red	EA
4 317 WP4	Black, Blue, Red and Green	4/ST
5 317 WP8	Yellow, Orange, Red, Green, Blue, Purple, Brown, and Black	8/ST



ii MEDIUM TIP, NON-PERMANENT

ORDER NUMBER	DESCRIPTION	UNIT
1 315-9	Black	EA
2 315-3	Blue	EA
3 315-2	Red	EA
4 315 WP4	Black, Blue, Red and Green	4/ST
5 315 WP8	Yellow, Orange, Red, Green, Blue, Purple, Brown, and Black	8/ST



BUY MORE SAVE MORE

iii FINE TIP, PERMANENT

ORDER NUMBER	DESCRIPTION	UNIT	1-9	10
1 318-9	Black	EA		
2 318-3	Blue	EA		
3 318-2	Red	EA		
4 318 WP4	Black, Blue, Red and Green	4/ST		
5 318 WP8	Yellow, Orange, Red, Green, Blue, Purple, Brown, and Black	8/ST		



iv FINE TIP, NON-PERMANENT

ORDER NUMBER	DESCRIPTION	UNIT
1 316-9	Black	EA
2 316-3	Blue	EA
3 316-2	Red	EA
4 316 WP4	Black, Blue, Red and Green	4/ST
5 316 WP8	Yellow, Orange, Red, Green, Blue, Purple, Brown, and Black	8/ST



v SUPER-FINE TIP, PERMANENT

ORDER NUMBER	DESCRIPTION	UNIT
1 313-9	Black	EA
2 313 WP4	Black, Blue, Red and Green	4/ST



vi SUPER-FINE TIP, NON-PERMANENT

ORDER NUMBER	DESCRIPTION	UNIT
1 311-9	Black	EA
2 311 WP4	Black, Blue, Red and Green	4/ST

Writing – pen style and specialty markers



A SCHNEIDER LINE-UP FINELINER MARKERS

Awarded with the world's best-known eco-label "Blue-Angel". Pen body made up of 88% bio-based plastic. Cap-off ink does not run dry even after 2 to 3 days. Rubberized triangular barrel. 0.4 mm. Assorted colours.

ORDER NUMBER	UNIT
1 RS191094	4/PK
2 RS191098	8/PK

B UNI® EMOTT FINE LINE MARKERS

Minimalistic, simple, sophisticated. Durable tip will not bend or split. Sleek white barrel. Water-resistant, non-bleed, non-fade ink. 0.4 mm. Assorted Colours.



ORDER NUMBER	UNIT
24828C	5/PK

NEW!

C SHARPIE® S-NOTE™ DUO CREATIVE MARKERS

One end of these colouring markers is a fine bullet tip, while the other is a versatile chisel tip, letting you easily switch between fine lines and broad strokes. No-bleed ink keeps your work looking clean. Chisel tip and fine tips. Assorted Colours.



ORDER NUMBER	DESCRIPTION	UNIT
1 2154173	Specify colour	8/PK
2 2154174	Assorted colours	16/PK



D STAEDTLER® DUO FIBRE-TIP MARKERS

These double-ended markers allow for 2 times the creative freedom. Widths range from 0.5 mm to 3.0 mm. Box made with 100% post consumer recycled PET, barrels made with 100% recycled material. Assorted colours.

ORDER NUMBER	UNIT
3280 C24LU	24/PK



E SHARPIE® S-NOTE CREATIVE MARKERS

Versatile and fun, they're both a marker and a highlighter, adding a splash of colour to note-taking, underlining, highlighting, drawing and more. Features no-bleed ink in translucent colours. Chisel tip. Assorted colours.

ORDER NUMBER	UNIT
2117329	12/PK



F EXPO® VIS-À-VIS WET ERASE MARKERS

EXPO® Vis-à-Vis Wet Erase Markers are ideal for writing on overhead projectors, transparencies and laminated calendars. The ink wipes off easily from most non-porous surfaces with a damp cloth. Fine point.

ORDER NUMBER	DESCRIPTION	UNIT
1 16001	Black	EA
2 2134341	Black, Blue, Red, Green	PK

Writing – specialty markers

A ELMER'S® BOARDMATE® CHALK MARKERS

Looks like chalk... without the dust! Acts like a marker, with bullet tip. Erase easily with a damp cloth. Washable, odorless, safe & non-toxic. Available in assorted colour pack: White, Orange, Pink, Blue.



ORDER NUMBER	DESCRIPTION	UNIT
E152M	Assorted	4/PK



C DIXON INDUSTRIAL® REACH® DEEP HOLE PERMANENT MARKERS

Multi-purpose marking tool for hard to reach places such as drilled holes and tight corners. Also great for DIY art projects. Marks on most wet and dry surfaces. Black.

ORDER NUMBER	UNIT
72067-14201	EA



E DIXON® CHINA MARKER®

Writes on glass, porcelain, plastic, paper, wood, cellophane. Indelible on porous surfaces. Removable on smooth surfaces. Coloured core wrapped in paper is easily unravelled to expose new point. Colours: **71** Crimson Red, **73** Yellow, **74** Green, **77** Black, **79** Red, **80** Blue, **92** White.

**BUY MORE
SAVE MORE**

ORDER NUMBER	DESCRIPTION	UNIT	1-11	12
72067-000	Specify colour	EA		



G PENTEL® WHITE MARKERS

Liquid white ink in a valve controlled ink feed marker. Permanent ink. Bullet point tips in Fine, Medium or Broad.



ORDER NUMBER	DESCRIPTION	UNIT
1 X100W-M	Medium	EA
2 X100W-W	Broad	EA
3 X100W-S	Fine	EA



B SHARPIE® CHALK MARKERS

Opaque chalk markers perfect for use on black boards, white boards and glass. Wipes off with a damp cloth. Medium tip.

ORDER NUMBER	DESCRIPTION	UNIT
1 2103010	White	2/PK
2 2103015	Red, Blue & Yellow	3/PK
3 2103006	Purple, Green & Orange	3/PK
4 2103011	White, Red, Blue, Yellow & Green	5/PK



D JIFFY ARTLINE™ LAUNDRY MARKER

The writing won't fade away when you wash your clothes repeatedly in detergent with either hot or cold water. The ink is also designed to be resistant to dry cleaning. Bullet tip with 0.7 mm nib size.

ORDER NUMBER	DESCRIPTION	UNIT
EK750/1B	Black	EA



F JIFFY ARTLINE™ SECURE REDACTING MARKER

The special black ink obscures private information. Perfect for hiding personal information on mail and packages. Useful for obscuring information on prescription bottles, price tag and sensitive documents. Covered information can't be easily read, scanned or copied. Works best on printed black ink. 4.0mm chisel tip.

ORDER NUMBER	DESCRIPTION	UNIT
EKSC-4	Black	EA

H PILOT® FRIXION ERASABLE COLOURING MARKERS

Erasable markers for marking or colouring. Easy to use, safe for children – no residue no odour. With 2.5 mm polyester fibre tips.



ORDER NUMBER	DESCRIPTION	UNIT
1 SW-FC-S6	6 colours	ST
2 SW-FC-S12	12 colours	ST

**NEW
PRODUCT** !!



AM13



Pentel® AM13 Heavy Duty Mechanical Pencil and CH13-HB Lead Pack (1.3mm) AM13LBP

Strong, heavy duty, high quality lead pencil is perfect for a variety of uses. Marks on tile, wood, drywall, concrete and paper. Constructed with a sturdy metal clip that withstands repeated use. Durable metal tip and 4mm sleeve stabilizes lead to prevent breakage. Ideal for use in woodworking shops, on construction sites or other active working environments.

FOLLOW US ON SOCIAL MEDIA
PENTEL CANADA



Discover the best

Pentel

uni FEATURE



A UNI® CHROMA MECHANICAL PENCIL

Comfortable hour-glass shape with a break-resistant shock absorbing cushioned point. Convenient side-click and auto lead advance Auto Lead advance. Hexagonal mini twist eraser for super clean erase. Rubberized grip.

ORDER NUMBER	DESCRIPTION	UNIT
1 70134	0.7mm, Cobalt Blue	EA
2 70135	0.7mm, Red	EA
3 90192C	0.7mm, includes leads + eraser refill	2/PK



E PENTEL® WOW! MECHANICAL PENCILS

Keep writing even if your lead breaks with sliding sleeve technology. Unique triangle shaped barrel and grip makes it easy to hold and keeps pencil from rolling off desk. Rubber grip. Barrel colours: **A** Black, **C** Blue.

ORDER NUMBER	DESCRIPTION	UNIT
1 AL405-__	0.5 mm, specify colour	EA
2 AL407-__	0.7 mm, specify colour	EA



G UNI® KURU TOGA MECHANICAL PENCIL SET

Exclusive rotating lead mechanism helps prevent lead breakage. Plastic clip and end cap. Includes 10 leads and 2 eraser refills.

ORDER NUMBER	DESCRIPTION	UNIT
1960518	0.7 mm, Black	PK



I PENTEL® ENERGIZE™ RETRACTABLE MECHANICAL PENCIL

Tip conveniently retracts to protect pockets and purses. Grooved, latex free rubber grip; stationary eraser and tip, fixed sleeve. Smooth, sleek barrel accented by bright colours and silver trim.

ORDER NUMBER	DESCRIPTION	UNIT
1 PL75-A	0.5 mm, Black	EA
2 PL75-V	0.5 mm, Violet	EA
3 PL77-A	0.7 mm, Black	EA
4 PL77-S	0.7 mm, Sky blue	EA



B PAPER MATE® COMFORTMATE ULTRA™ MECHANICAL PENCIL

Unique hourglass shape for a comfortable fit in your hand. Soft grip provides added control. Assorted colours.

ORDER NUMBER	DESCRIPTION	UNIT
1 1738797	0.5 mm	EA
2 1738798	0.7 mm	EA



C ZEBRA M-301 MECHANICAL PENCIL

Push button lead advance. Features stainless steel barrel and comfort finger grips.

ORDER NUMBER	DESCRIPTION	UNIT
45888-54010	0.5 mm	EA



D BIC® MECHANICAL PENCIL XTRA LIFE

Lightweight, comfortable alternative to a woodcase pencil. Includes 3 full-length HB leads.

ORDER NUMBER	DESCRIPTION	UNIT
1 70330-91077	0.5 mm	12/BX
2 70330-90085	0.7 mm	12/BX



F BIC® EXTRA COMFORT MECHANICAL PENCILS

Includes three full length HB leads. Rubber grip.

ORDER NUMBER	DESCRIPTION	UNIT
1 70330-40692	0.5 mm	12/BX
2 70330-40473	0.7 mm	12/BX



H BIC® SHIMMERS® MECHANICAL PENCILS

Sharp, precise and clean lines support neat penmanship. Lead advances with just a click and is always ready to write, no need to sharpen. Assorted coloured barrels.

ORDER NUMBER	DESCRIPTION	UNIT
70330-40696	0.7 mm	24/PK



J BIC® REVOLUTION™ MECHANICAL PENCILS

Made from 65% recycled plastic. Bright colourful barrels in yellow, green, red and blue, plus a handy clip to attach pencil to pockets. Plastic grip. 3 HB leads and built-in eraser.

ORDER NUMBER	DESCRIPTION	UNIT
70330-43735	0.7 mm	12/PK



OFFICE SUPPLIES



A PENTEL® ORENZ MECHANICAL PENCILS

Unique pipe mechanism allows an extra long write out without having to click. Lead guide pipe protects the lead and has rounded edge so you can write without scratching the paper. Anti-breaking lead mechanism.

ORDER NUMBER	DESCRIPTION	UNIT
1 PP505-A	0.5 mm, Black	EA
2 PP507-C	0.7 mm, Blue	EA



NEW!

D PENTEL® SHARP HEAVY DUTY MECHANICAL PENCIL

Ultra-thick lead easily writes smoother, bolder, darker lines. Marks on tiles, wood, drywall, concrete and paper. Sturdy metal clip. Protective cap to keep high-quality eraser clean. Includes 1 tube of lead refills.

ORDER NUMBER	DESCRIPTION	UNIT
AM13LBP	1.3 mm, Blue	PK



F PAPER MATE® PROFILE® MECHANICAL PENCILS

Features comfortable signature Profile® grip. Includes 5 eraser refills and 1 tube of 6 lead refills.

ORDER NUMBER	DESCRIPTION	UNIT
2105701	0.7 mm, Black & Blue	2/PK



H PAPER MATE® CLEARPOINT® MECHANICAL PENCILS

Eye-catching design with side lead advance button.

ORDER NUMBER	DESCRIPTION	UNIT
1 56037	0.5 mm	EA
2 56043	0.7 mm	EA



J PILOT® G2 MECHANICAL PENCILS

Comfortable rubberized grip, full sliding sleeve, spare eraser.

ORDER NUMBER	DESCRIPTION	UNIT
1 HG2-185-BK	0.5 mm, Black	EA
2 HG2-187-BK	0.7 mm, Black	EA



B BIC® PREVAGUARD™ MEDIA CLIC™ MECHANICAL PENCILS

PrevaGuard™, an EPA registered antimicrobial additive is incorporated directly into the pencil's plastic components to suppress the growth of bacteria, moulds, mildew and fungi. Lasts for the lifetime until plastic is destroyed. Includes 3 leads.



ORDER NUMBER	DESCRIPTION	UNIT
70330-43804	0.7 mm, Black	4/PK



C PENTEL® MECHANICAL PENCIL

Plastic hexagonal barrel for precise writing.

ORDER NUMBER	DESCRIPTION	UNIT
1 P205-A	0.5 mm, Black	EA
2 P207-C	0.7 mm, Blue	EA
3 P209-G	0.9 mm, Yellow	EA



E STAEDTLER® TRIPLUS® MICRO MECHANICAL PENCILS

Ergonomic triangular barrel for fatigue free writing. Blue.

ORDER NUMBER	DESCRIPTION	UNIT
1 77425-30A6	0.5 mm	EA
2 77427-30A6	0.7 mm	EA
3 77413-30A6	1.3 mm	EA



G PENTEL® SENSI-GRIP MECHANICAL PENCIL

With rubber finger grip and metal pocket clip. Automatically feeds lead.

ORDER NUMBER	DESCRIPTION	UNIT
A315-A	0.5 mm, Black barrel	EA



I STAEDTLER® ELITE MECHANICAL PENCILS

Retractable, cushioned metal writing tip. Rubber grip. Metal clip and end cap. Assorted colours.

ORDER NUMBER	DESCRIPTION	UNIT
1 9705S	0.5 mm	EA
2 9707S	0.7 mm	EA



K PILOT® BEGREEN® PROGREG MECHANICAL PENCIL

Full sliding sleeve protects lead in use and safely retracts for portability. Contains a minimum of 70% recycled material. 0.7 mm colours: **BK** Black, **BE** Blue.

ORDER NUMBER	DESCRIPTION	UNIT
1 BG-H125SL-BE	0.5 mm, Blue	EA
2 BG-H127SL-__	0.7 mm, specify colour	EA

Writing – mechanical pencil accessories

C25-HB



C505-HB



50



C27-HB



A PENTEL® HI-POLYMER LEADS

In tubes made from 100% recycled plastic. Grades: **2B, B, HB, H, 2H.**

ORDER NUMBER	DESCRIPTION	UNIT
0.5 MM		
1 C505BP2-___	Specify grade, 12 leads/tube, 2 tubes/PK	PK
2 C505-___	Specify grade, 12 leads/tube, 12 tubes/BX	BX
3 C25BP-HB	HB, 30 leads/tube	EA
0.7 MM		
4 50BP2-HB	HB, 12 leads/tube, 2 tubes/PK	PK
5 50-___	Specify grade, 12 leads/tube, 12 tubes/BX	BX
6 C27BP-HB	HB, 30 leads/tube	EA
0.9 MM		
7 50BP2-HB9	HB, 15 leads/tube, 2 tubes/PK	PK



D STAEDTLER® MARS® MICRO CARBON LEADS

High break resistance due to flexible leads. HB.

ORDER NUMBER	DESCRIPTION	UNIT
1 250 05-HB	0.5 mm	12/TUBE
2 250 07-HB	0.7 mm	12/TUBE
3 250 13-HB	1.3 mm	6/TUBE



F MERANGUE PENCIL LEADS

Super strong resin lead. HB. 30 leads per tube.

ORDER NUMBER	DESCRIPTION	UNIT
1 3872-3041-00-000	0.5 mm	3/PK
2 3872-3051-00-000	0.7 mm	3/PK



H ERASER REFILLS

ORDER NUMBER	DESCRIPTION	UNIT
1 MS-10	Pilot® eraser refill	5/PK
2 Z2-1N	Pentel® eraser refill	4/TB
3 45888-83410	Zebra eraser refill	5/PK
4 E10	Pentel® eraser refill	3/PK



B PILOT® ENO-G LEADS

Ensures smooth writing with stronger and darker strokes. 48 leads per pack.

ORDER NUMBER	DESCRIPTION	UNIT
1 P48	0.5 mm, HB, 48 leads per pack	PK
2 P748	0.7 mm, HB, 48 leads per pack	PK

C PENTEL® AIN STEIN REFILL LEADS

Pentel Ain Stein lead is 30% stronger than the competitive average. New streamlined twist cap container in vivid colours. Made with 92% recycled material.



ORDER NUMBER	DESCRIPTION	UNIT
1 C275BP-HB	HB, 40 leads per pack	PK
2 C275-HB	HB, 40 leads per tube, 12 tubes/box	BX
3 C277BP-HB	HB, 40 leads per pack	PK
4 C277-HB	HB, 40 leads per tube, 12 tubes/box	BX

E STAEDTLER® MARS LEAD POINTER

Sharpener for 2 mm leads with automatic sharpening stop. Includes measurement device for adjusting sharpening cone. Metal sharpener with integrated dust wiper.



ORDER NUMBER	UNIT
502 BK A6	EA

G STAEDTLER® MARS TECHNICO LEAD HOLDER

Professional 2 mm lead drafting pencil. Knurled, non-slip finger grip; built-in lead pointer.

ORDER NUMBER	DESCRIPTION	UNIT
780 BK	Lead holder	EA



I STAEDTLER® 2 mm LEADS

Lead grades: **HB HB, 2H 2H, 2B 2B.**

ORDER NUMBER	DESCRIPTION	UNIT
1 200-___	Specify grade	12/PK
2 200 E2-___ NA	Specify grade	2/TB



STAEDTLER®

Head of ideas.



100%
Certified wood

A history of pencil making

STAEDTLER was founded in 1835 and is the largest European manufacturer of wood-cased pencils

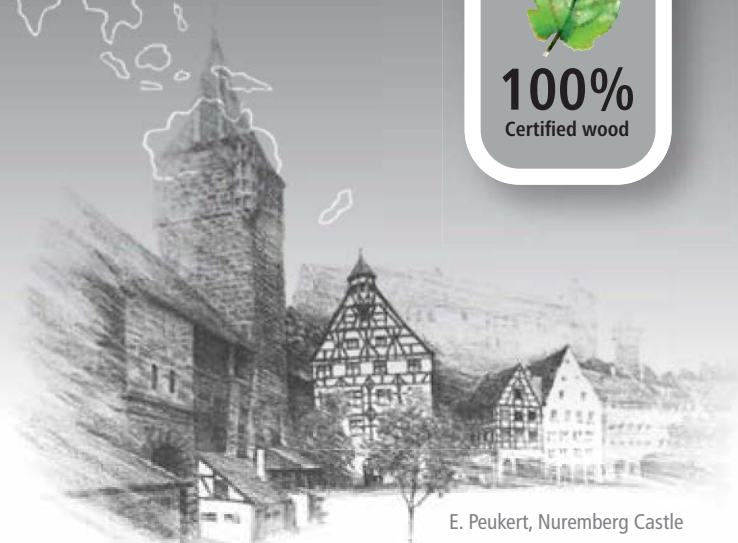

E. Peukert, Nuremberg Castle



Mars® Lumograph® - The Sketch Pencil

Special lead formulation for results with a metallic lustre in a wide variety of grey tones that artists love.



Norica - The Premium Pencil

The standard for everyday writing. Unbelievably break-resistant through special lead formulation and super-bonded lead.



The Entry Level Pencil

Innovative material is easy to sharpen - a value priced quality pencil in standard yellow, metallic and neon barrel colours.

Our Brand, YOUR Savings !

A OP BRAND PENCILS
Premium HB pencils with eraser tip. Unsharpened.

ORDER NUMBER	DESCRIPTION	UNIT
27811-50004	HB	12/BX



C PAPER MATE® EVERSTRONG® PENCILS
Reinforced, break-resistant lead and latex free eraser.

ORDER NUMBER	DESCRIPTION	UNIT
1 2067423	HB	10/PK
2 2105642	HB	72/PK



G STAEDTLER® GRAPHITE PENCILS
Innovative extruded polymer, easy to sharpen and pre-sharpened. White latex-free eraser.

ORDER NUMBER	DESCRIPTION	UNIT
1 17247PB10	HB, Yellow	10/PK
2 17247FPB20	HB, Assorted Neon colours	20/PK
3 17247MPB20	HB, Assorted Metallic colours	20/PK



I DIXON® LUMBER CRAYONS
Extruded to last up to 10 times longer than ordinary moulded wax crayons. Fade-proof, water-proof, smear-proof and won't melt in direct sunlight. Works on wet (green) lumber, or dry wood, metal, concrete, etc. Includes a bonus pink lumber crayon. Assorted Colours.

ORDER NUMBER	UNIT
72067-49407	6/PK

STAEDTLER® FEATURE



B STAEDTLER® NORICA PENCILS
Premium pencils with a latex-free eraser. Break resistant thanks to the super bonded lead.

ORDER NUMBER	DESCRIPTION	UNIT
1 13246CB12	HB	12/BX



D STAEDTLER® WOODCASED PENCILS
Pre-sharpened yellow school woodcased pencils. Latex free eraser tip. Easy to sharpen. HB/#2. FSC® Certified.

ORDER NUMBER	DESCRIPTION	UNIT
1 13247C12A6	HB	12/BX
2 13247C144A	Class Pack	144/BX



E DIXON® TICONDEROGA® PREMIUM GRAPHITE CORE PENCILS
Lead grades: 2 HB, 4 2H, 5 F.

ORDER NUMBER	DESCRIPTION	UNIT
1 72067-1388	Unsharpened, specify grade	12/BX
2 72067-13830	Pre-sharpened, HB	30/BX



F PAPER MATE® CANADIANA® PENCIL
Everyday office pencil with medium soft lead. Unsharpened.

ORDER NUMBER	DESCRIPTION	UNIT
7364022420	HB	12/BX



H DIXON® PRIMARY PRINTER PENCILS
The beginners' choice for that important first pencil. Oversized diameter makes the Primary Printer easy for little hands to hold.

ORDER NUMBER	DESCRIPTION	UNIT
1 72067-18997	#1, 1½" diameter	12/BX
2 72067-18995	#2, 1½" diameter	12/BX



J DIXON® GOLF PENCILS
Enviro Stik untipped.

ORDER NUMBER	DESCRIPTION	UNIT
72067-15099	HB	144/BX

OFFICE SUPPLIES

NEW!

NEW!

A STAEDTLER® MARS VINYL ERASER

Clean, white non-abrasive eraser in a protective sleeve for use with bond or drafting vellums.



ORDER NUMBER	DESCRIPTION	UNIT
1 526 50 UP	Plastic	EA
2 525 B20	NEW! PVC and Latex free	EA



NEW!

C WESTCOTT® RETRACTABLE ERASER

Smudge free for clean corrections. 100% latex free. Ergonomic grip. Includes refill. Black and Blue.

ORDER NUMBER	DESCRIPTION	UNIT
65956-15687	Eraser and Holder	EA



E PENTEL® CLIC ERASER AND REFILL

Quality white vinyl eraser in a ratchet holder. The pocket clip advances the eraser as required. Blue.

ORDER NUMBER	DESCRIPTION	UNIT
1 ZE22-C	Eraser and Holder	EA
2 ZER-2	Eraser refill	2/PK



F STAEDTLER® PEN STYLE ERASER HOLDER

With pocket clip. White, non-abrasive eraser.

ORDER NUMBER	DESCRIPTION	UNIT
1 528 50	Eraser and holder	EA
2 528 55	Eraser refill	EA



H MERANGUE PENCIL CASE

Oblong shaped. 420 denier nylon. Features 2 zippers. Black.

ORDER NUMBER	UNIT
1015-4390-20-000	EA



B DIXON® ERASERS

ORDER NUMBER	DESCRIPTION	UNIT
1 72067-77001	Medium #100	EA
2 72067-77003	Large #101	EA
3 72067-79003	Wedge tip #1212	25/BX
4 72067-39700	White Vinyl Pearl medium	EA
5 72067-39701	White Vinyl Pearl large	EA
6 72067-38965	Mini Neon NEW!	5/PK

D VLB® PENCIL GRIP

The standard in pen grips and pencil grips, recommended by doctors and occupational therapists. For right and left handed writers; bright, contemporary colours.



ORDER NUMBER	UNIT
00179-0	EA



G MERANGUE® COMFORT PENCIL GRIPS

Assorted colours.

ORDER NUMBER	DESCRIPTION	UNIT
1 1017-3021-00-000	Foam rubber	5/PK
2 1017-4161-00-000	Soft silica gel	2/PK



I STOREX® PLASTIC PENCIL BOX

Clear bottom allows for quick and easy identification of contents. Lid snaps shut with an integrated latch. Durable plastic construction. 8.38"L x 5.63"W x 2.875"H

ORDER NUMBER	DESCRIPTION	UNIT
1 61623U12C	Blue	EA
2 61605U12C	Assorted colours	EA

X-ACTO®

X-ACTO

X-ACTO

Improved Performance, Modern Design

New & improved X-ACTO® Break Resistant Electric Sharpeners now expect **reduced pencil lead breakage** while sharpening, along with **coloured pencils compatibility** and **extended blade life** across our full electric sharpener portfolio.



Our Brand, YOUR Savings !



A OP BRAND ELECTRIC PENCIL SHARPENER

Designed for high volume use in the office, classroom or home. Super quiet. Sensing technology lets you feel when pencil is sharpened to the perfect point. Extra-large transparent shavings reservoir allows you to see when reservoir needs emptying. Black.



ORDER NUMBER	UNIT
27811-50100	EA

C X-ACTO® MIGHTY MITE® ELECTRIC PENCIL SHARPENER

Prevents over sharpening and is coloured pencil compatible. Stops when the shavings bin is removed and has a slip resistant bottom.



ORDER NUMBER	UNIT
19501XT	EA

E X-ACTO® SCHOOL PRO® ELECTRIC PENCIL SHARPENER

Stops when the shavings bin is removed and stops sharpening when the pencil reaches ideal sharpness. Coloured pencil compatible. It has a slip resistant bottom and an extra large shavings bin.



ORDER NUMBER	UNIT
1670XT	EA

G X-ACTO® MANUAL PENCIL SHARPENER

Retro-style chrome finish. X-ACTO® cutters for precise cutting and long life. Screw mount, for fixing on flat surfaces or walls. Versatile model sharpens 8 pencil sizes. Includes a 10-year warranty.



ORDER NUMBER	DESCRIPTION	UNIT
79946-11031	8 hole (1031T)	EA



B BOSTITCH® QUIETSHARP™ 6 CLASSROOM ELECTRIC PENCIL SHARPENER

Features quiet industrial motor with automatic thermal overload protection. Single helical cutter, high-capacity shavings receptacle, stable oversized base.



ORDER NUMBER	DESCRIPTION	UNIT
EPS10HC	Quiet Sharp 6	EA

D X-ACTO® QUIET PRO® ELECTRIC PENCIL SHARPENER

Works with all pencils with the auto-adjust dial. Coloured pencil compatible. LED light lets the user know when the pencil is done sharpening. Prevents over sharpening and stops when the shavings bin is removed. Ultra quiet motor and slip resistant bottom.



ORDER NUMBER	UNIT
1612XT	EA

F X-ACTO® XLR™ ELECTRIC PENCIL SHARPENER

Prevents over sharpening and stops when the shavings bin is removed. Coloured pencil compatible. Slip resistant bottom.



ORDER NUMBER	UNIT
1818XT	EA



H BOSTITCH® ANTIMICROBIAL MANUAL PENCIL SHARPENER

Antimicrobial properties built-in. Features dual cutters which can be easily removed for cleaning or replacement. Prevents over sharpening. Durable, all metal design. Large capacity shavings receptacle. Includes screws for mounting.



ORDER NUMBER	UNIT
MPS1-BLK	EA

Writing – pencil sharpeners



A BOSTITCH® QUIETSHARP™ EXECUTIVE ELECTRIC PENCIL SHARPENER

Unique angled cutter head for controlled sharpening by the hardened steel cutting blades. Auto stop feature will prevent over sharpening. Easy to remove shaving tray, 6' power cord. Black.



ORDER NUMBER	UNIT
EPS8HD-BLK	EA



C BOSTITCH® ELECTRIC PENCIL SHARPENER

Sharpens faster than competitor models. Hardened steel helical blades, compact design, auto stop. Safety feature that stops motor when receptacle is removed.



ORDER NUMBER	UNIT
EPS4-BLACK	EA

E X-ACTO® INSPIRE+® HEAVY DUTY BATTERY PENCIL SHARPENER

Hardened steel helical cutter for maximum durability that is perfect for a small office, in the home or on the go. Requires 4 AA batteries (not included).



ORDER NUMBER	UNIT
1781T	EA



G WESTCOTT® KLEENEARTH® PENCIL SHARPENER

All metal single hole sharpener inside a plastic casing. Plastic parts contain an antimicrobial agent to help inhibit the growth of bacterial stains and odours. Plastic components made from 20% recycled content.



ORDER NUMBER	UNIT
65956-02434	EA

B X-ACTO® POWERHOUSE® ELECTRIC PENCIL SHARPENER

The Pencil Saver® prevents over-sharpening. Optimized for sharpening coloured pencils and stops when the shavings bin is removed. The bottom is slip resistant.



ORDER NUMBER	UNIT
1799XT	EA

D WESTCOTT® IPOINTE® BALL BATTERY PENCIL SHARPENER

Unique shape stands out, makes it easy to find and easy to hold. Dual cutting blades for sharpening speed and longevity. Safety shut off. One year warranty. Uses 4 "AA" batteries (not included).



ORDER NUMBER	DESCRIPTION	UNIT
65956-15570	Single hole	EA

F STAEDTLER® ALL METAL PENCIL SHARPENERS



ORDER NUMBER	DESCRIPTION	UNIT
1 510 10 A6	Single hole	EA
2 510 20 A6	Double hole	EA



H STAEDTLER® PENCIL SHARPENERS WITH CONTAINERS

ORDER NUMBER	DESCRIPTION	UNIT
1 511 63	Single hole	EA
2 511 100 NA	Single hole	EA
3 512 300S NA	Double hole	EA
4 512 001 A6	Double hole	EA



A SWINGLINE® FIXED BLADE ROTARY TRIMMER

The safely concealed rotary blade, easy grip handle and sturdy metal base make this trimmer simple to use and ensures it will last. Features an alignment grid, dual scale ruler and transparent cutting guide. Cuts up to 8 sheets of 20 lb. paper.

ORDER NUMBER	DESCRIPTION	UNIT
G7010007	12" cutting length	EA

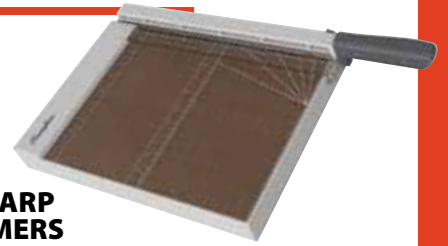

B SWINGLINE® SHARP GUILLOTINE TRIMMERS

A guillotine like blade made from premium materials for long lasting sharpness with built in guard rail and latch to lock the trimmer for added safety. Features an alignment grid and dual scale ruler for accurate measurement. EdgeGlow™ illuminated LED cutting edge provides accurate indication of cut line location. Cuts up to 10 sheets of 20 lb. paper.

ORDER NUMBER	DESCRIPTION	UNIT
1 G7010011	12" cutting length	EA
2 G7010012	15" cutting length	EA



C SWINGLINE® ROTARY TRIMMER WITH CARTRIDGE

Easily create quality cuts on documents, photos and artwork. Safely concealed rotary blade and easy grip handle make this trimmer simple to use, while its sturdy metal base ensures that it will last through project after project. Features an alignment grid, dual scale ruler and transparent cutting guide. Perf and Wave blade included. Cuts up to 15 sheets of 20 lb. paper.

ORDER NUMBER	DESCRIPTION	UNIT
1 G7010009	12" cutting length	EA
2 G7010009RSB	Replacement straight blade	2/PK
3 G7010009RCM	Replacement cutting mat	2/PK

NEW!
NEW!

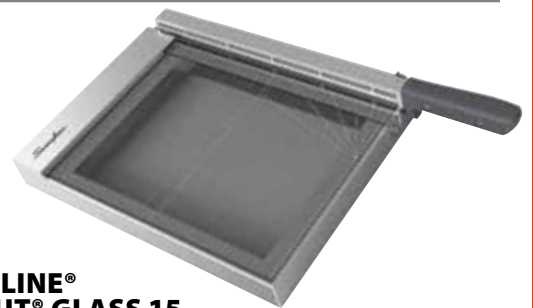

D SWINGLINE® CLASSICCUT® GLASS 15 GUILLOTINE TRIMMERS

Base made from high-quality glass, has molded rubber grip for added comfort, and a Plastic frame. Features an alignment grid and dual scale ruler for accurate measurement. EdgeGlow™ illuminated LED cutting edge provides accurate indication of cut line location. Cuts up to 15 sheets of 20 lb. paper.

ORDER NUMBER	DESCRIPTION	UNIT
G7010013	12" cutting length	EA

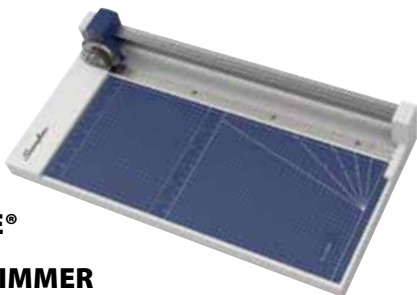

E SWINGLINE® CLASSICCUT® BY-PASS 10 TRIMMER

Rotary cutting action with concealed stainless steel blade. Heavy-duty steel base has both metric and imperial measurements. Features an alignment grid, dual scale ruler and transparent cutting guide. Cuts up to 10 sheets of 20 lb. paper.

ORDER NUMBER	DESCRIPTION	UNIT
1 G7010008	12" cutting length	EA
2 G7010008RRB	Replacement blade	2/PK

NEW!

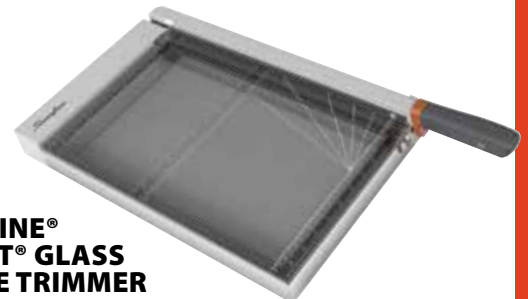

F SWINGLINE® CLASSICCUT® GLASS GUILLOTINE TRIMMER

With EdgeGlow LED illumination, (3 AAA batteries included), it's easy to align your papers for a perfect cut. The thick, tempered glass surface is printed with alignment guides to help improve accuracy. The sturdy metal frame keeps it stable while cutting and the safety latch keeps the blade in place when it's not in use.

ORDER NUMBER	DESCRIPTION	UNIT
1 G7010005	12" cutting length	EA
2 G7010006	15" cutting length	EA

G WESTCOTT® TITANIUM BONDED® TRIMAIR GUILLOTINE TRIMMER

Titanium Bonded® cutting blade stays sharper longer. Plastic parts contain an antimicrobial agent to help inhibit the growth of bacterial stains and odours. Safety built in with protective rail guard, front finger rest and blade latch hook. Cuts up to 30 sheets of 20 lb. paper. 15-year warranty.

ORDER NUMBER	DESCRIPTION	UNIT
65956-15108	18" cutting length	EA

NEW!



Our Brand, YOUR Savings! 



A OP BRAND SCISSORS
With plastic handles and fully ground stainless steel blades.

ORDER NUMBER	DESCRIPTION	UNIT
1 27811-10024	8", straight	EA
2 27811-10025	5½", pointed	EA
3 27811-10224	8", bent	3/PK



NEW!

B WESTCOTT® CARBOTITANIUM® HEAVY DUTY SCISSORS
CarboTitanium® blades 8 times harder than untreated stainless steel blades stay sharper longer. Unique high strength ergonomic over-molded handles with contoured soft grips. Lifetime warranty.

ORDER NUMBER	DESCRIPTION	UNIT
65956-16447	8", pointed	EA



C WESTCOTT® CARBOTITANIUM® GLIDE SCISSORS
Blades 8 times harder than untreated stainless steel blades stay sharper longer. Unique high strength ergonomic over-molded handles with contoured soft grips. New adjustable glide technology let you set the tension for optimal performance. Pointed tip. Lifetime warranty.

ORDER NUMBER	DESCRIPTION	UNIT
65956-17443	8"	EA



D WESTCOTT® ECONOMY SCISSORS
Economical and lightweight. Rust-resistant steel blades. Comfortable grip for left or right handed users. Pointed tip. 5-year warranty.

ORDER NUMBER	DESCRIPTION	UNIT
65956-02208	8"	EA



E WESTCOTT® LEFT-HANDED SCISSORS
Designed for left handed use. Durable handle and stainless steel blades. 10-year warranty.

ORDER NUMBER	DESCRIPTION	UNIT
65956-11257	7"	EA



F WESTCOTT® KLEENCUT KIDS SCISSORS
Comfortable scissors for small hands. Rounded or pointed tips. Assorted colours. 5-year warranty.

ORDER NUMBER	DESCRIPTION	UNIT
1 65956-40005	5", blunt	EA
2 65956-40025	5", pointed	EA



G WESTCOTT® X-RAY™ ANTIMICROBIAL SCISSORS
Ultra durable polycarbonate handle with soft grip inserts for added comfort. For left or right hand use. Handles contain an antimicrobial agent. 3 assorted colours. Lifetime warranty.

ORDER NUMBER	DESCRIPTION	UNIT
1 65956-14596	5", blunt ends	EA
2 65956-14597	5", pointed	EA
3 65956-66094	7", pointed NEW!	2/PK



H WESTCOTT® KLEENEARTH™ ANTIMICROBIAL SCISSORS
Plastic components contain 20% post-consumer content. Stainless steel blades. Handles contain an antimicrobial agent. 4 assorted colours. 10 year warranty.

ORDER NUMBER	DESCRIPTION	UNIT
65956-14835	5", blunt tips	EA

WESTCOTT *Since 1872* **FEATURE**

A WESTCOTT® TITANIUM BONDED® NON STICK SCISSORS

New proprietary technology bonds titanium with a revolutionary non-stick coating, making these scissors highly resistant to adhesives and other materials. Titanium Bonded® blades, five times harder than stainless steel, cut a wider variety of materials with a reduced coefficient of friction. Lifetime warranty.



ORDER NUMBER	DESCRIPTION	UNIT
1 73577-14881	5" straight	EA
2 65956-14851	7" straight	EA
3 65956-14849	8" straight	EA
4 65956-14850	8" bent	EA



B WESTCOTT® KLEENEARTH® SCISSORS

Corrosion resistant, stainless steel blades. Comfortable grip for left or right handed users. Contains a minimum of 30% post-consumer recycled plastic.

ORDER NUMBER	DESCRIPTION	UNIT
65956-13138	9"	EA



C WESTCOTT® KLEENEARTH® SOFT HANDLE SCISSORS

Stainless steel blades, blue handles, made from 20% post-consumer content. For right or left handed use. 10 year warranty.

ORDER NUMBER	DESCRIPTION	UNIT
1 65956-15552	6" straight	EA
2 65956-15553	7", straight	EA
3 65956-15554	8", straight	EA



D WESTCOTT® KLEENEARTH® SCISSORS

With hard black handles made from 70% recycled plastic with 30% post-consumer content. For use with left or right hand. Stainless steel blades. Choice of straight or bent handles. 10 year warranty.

ORDER NUMBER	DESCRIPTION	UNIT
1 65956-15582	7" straight	EA
2 65956-15583	8" straight	EA
3 65956-15584	8" bent	EA



E WESTCOTT® KLEENEARTH® SOFT HANDLE SCISSORS

Soft handles, made from 70% recycled plastic with 30% post-consumer content. For right or left handed use. Stainless steel blades. 10 Year warranty.

ORDER NUMBER	DESCRIPTION	UNIT
65956-15589	8" bent	EA



5" style

7" and 8" style

F WESTCOTT® TITANIUM BONDED® SCISSORS

Plastic handle with Titanium Bonded® blades, 3x harder than stainless steel alone. Corrosion resistant. Lifetime warranty.

ORDER NUMBER	DESCRIPTION	UNIT
1 65956-13525	5"	EA
2 65956-13526	7"	EA
3 65956-13529	8"	EA



G WESTCOTT® KLEENEARTH® ANTIMICROBIAL SCISSORS

Stainless steel blades; handles made from 20% post-consumer content, and contain an antimicrobial agent. For right or left handed use. 10 Year warranty.

ORDER NUMBER	DESCRIPTION	UNIT
1 65956-14834	7"	EA
2 65956-14820	8"	EA



Rulers & Measuring Tools

A WESTCOTT® PROTRACTOR

4" base, 180° coverage. Clear acrylic plastic.



ORDER NUMBER	UNIT
65956-00480	EA

B STAEDTLER® IMPERIAL TEMPLATES

Transparent green plastic is easy to see through and use.



ORDER NUMBER	DESCRIPTION	UNIT
1 977 110 NA	Combo circles	EA
2 977 115 NA	Pocket general purpose	EA

D STAEDTLER® COMPASS

Geo Master compass and lead box in a plastic carry pouch. Precision centre wheel for symmetrical circles up to 6" in diameter.

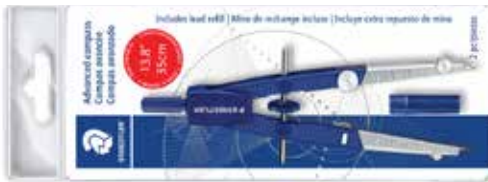

ORDER NUMBER	DESCRIPTION	UNIT
556 WP00A6	Blue/Chrome	EA



E STAEDTLER® 9 PIECE SCHOOL KIT

Plastic storage case contains Mars plastic mini eraser, 0.5mm mechanical pencil, plastic 45° and 60° set squares, 6" ruler and metal compass with universal adaptor.

ORDER NUMBER	UNIT
550 60S9	ST



G STAEDTLER® 10-PIECE MATH SET

In metal box.

ORDER NUMBER	UNIT
557 10 BN	ST

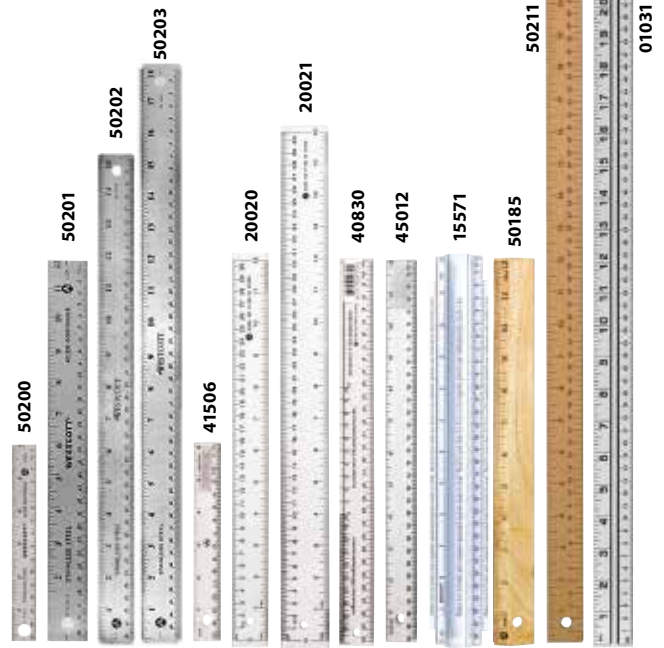

C WESTCOTT® RULERS

Acrylic and clear plastic models have bevelled edge; wooden 12" model is lacquered with steel edge.

ORDER NUMBER	DESCRIPTION	UNIT
1 65956-50200	Stainless steel/cork back, 6"/15 cm	EA
2 65956-50201	Stainless steel/cork back, 12"/30 cm	EA
3 65956-50202	Stainless steel/cork back, 15"/38 cm	EA
4 65956-50203	Stainless steel/cork back, 18"/45 cm	EA
5 65956-50204	Stainless steel/cork back, 24"/60 cm	EA
6 65956-41506	Plastic, 6"/15 cm	EA
7 65956-20020	Acrylic, 12"/30 cm	EA
8 65956-20021	Acrylic, 16"/40 cm	EA
9 65956-40830	Flexible vinyl, 30 cm	EA
10 65956-45012	Plastic, 12"/30 cm	EA
11 65956-15571	Magnifying ruler, 12"/30 cm	EA
12 65956-50185	Wooden, 12"/30 cm	EA
13 65956-50211	Wood metre stick, 39"/100 cm	EA
14 88359-01031	Aluminum metre stick, 39"/100 cm	EA

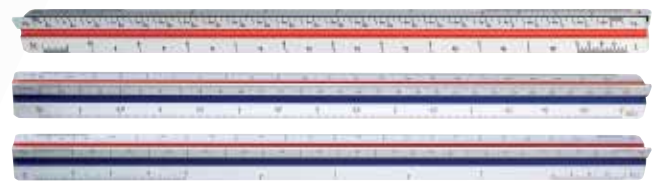

F STAEDTLER® TRIANGULAR SCALES

White solid plastic scales, 12"/30 cm, die-engraved graduations.

ORDER NUMBER	DESCRIPTION	UNIT
METRIC SCALES		
1 9871 ISOBK	Engineering, 1:2, 1:5, 1:10, 1:20, 1:50, 1:100	EA
2 987 18 1BK	Mechanical Engineering, Architects, 1:20, 1:25, 1:50, 1:75, 1:100, 1:125	EA
3 987 18 4BK	Architects, 1:100, 1:200, 1:250, 1:300, 1:400, 1:500	EA
IMPERIAL SCALES		
4 98718-31BK	Architects, 1/16, 3/32, 1/8, 1/4, 3/8, 1/2, 3/4, 1, 1 1/2, 3	EA
5 98718-34BK	Engineering, 10, 20, 30, 40, 50, 60	EA



A SUPREME X WINDOW ENVELOPES

Fully gummed flap for a secure seal. White. 24 lb. FSC® Certified.

ORDER NUMBER	DESCRIPTION	UNIT
SIDE SEAM		
1 0924445FSCNL	#9, 3 7/8" x 8 7/8"	500/BX
2 1024445FSCNL	#10, 4 1/8" x 9 1/2"	500/BX
DIAGONAL SEAM, V-FLAP		
3 3824440FSCNL	#10, 4 1/8" x 9 1/2"	500/BX

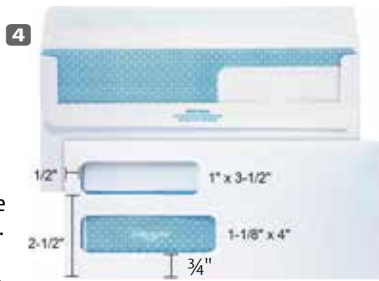

C FLIP-N-FOLD SECURITY ENVELOPES

No moisture needed. Just lift the flap and press for a secure seal. Perforations along the flap reveal evidence of tampering. Security tinted. Side seam.

ORDER NUMBER	DESCRIPTION	UNIT
1 QUA67539	#8 3/8, 3 3/8" x 8 3/8", double window	500/BX
2 1004480FSCNL	#10, 4 1/8" x 9 1/2", plain	500/BX
3 1005480FSCNL	#10, 4 1/8" x 9 1/2", window	500/BX
4 QUA24559	#10, 4 1/8" x 9 1/2", double window	500/BX



E SUPREME X PEEL & SEAL SECURITY ENVELOPES

Sturdy white envelopes with fast and easy sealing closure. Features a peel and seal closure forming a security seal. Security tinted. Plain. 24 lb. White. FSC® Certified.

ORDER NUMBER	DESCRIPTION	UNIT
1018480FSCNL	#10, 4 1/8" x 9 1/2"	500/BX

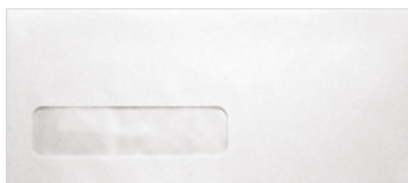

B PLAIN ENVELOPES

Fully gummed flap for a secure seal. White. 24 lb.

ORDER NUMBER	DESCRIPTION	UNIT
SIDE SEAM		
1 0800440FSCNL	#8, 3 3/8" x 6 1/2"	1000/BX
2 0900445FSCNL	#9, 3 7/8" x 8 7/8" FSC Certified	500/BX
3 1000445FSCNL	#10, 4 1/8" x 9 1/2" FSC Certified	500/BX
DIAGONAL SEAM, V-FLAP		
4 65800-36510	#8, 3 3/8" x 6 1/2"	70/BX
5 65800-36612	#10, 4 1/8" x 9 1/2"	50/BX
6 3800440FSCNL	#10, 4 1/8" x 9 1/2"	500/BX



D CONFIDENTIAL ENVELOPES

Tinted interior with a gummed seal. White.

ORDER NUMBER	DESCRIPTION	UNIT
PLAIN		
1 65800-36511	#8, 3 3/8" x 6 1/2"	50/BX
2 65800-36613	#10, 4 1/8" x 9 1/2"	40/BX
3 19003	#10, 4 1/8" x 9 1/2"	100/PK
4 1000480FSCNL	#10, 4 1/8" x 9 1/2"	500/BX
WINDOW		
5 19004	#10, 4 1/8" x 9 1/2"	100/PK
6 1024480FSCNL	#10, 4 1/8" x 9 1/2"	500/BX



F PRESS-IT SEAL-IT® ENVELOPES

Self-adhesive closure. Peel off the protective strip and press down for a strong secure closure. Side seam. 20 lb. White.

ORDER NUMBER	DESCRIPTION	UNIT
PLAIN		
1 65800-36710	#8, 3 3/8" x 6 1/2"	65/BX
2 65800-36712	#10, 4 1/8" x 9 1/2"	50/BX
SECURITY TINT		
3 65800-36711	#8, 3 3/8" x 6 1/2"	55/BX
4 65800-36713	#10, 4 1/8" x 9 1/2"	45/BX

G DIGITAL WINDOW ENVELOPES

Designed for digital printing. Crystal clear heat resistant window film. Meets Canadian and US postal standards. FSC® Certified.

ORDER NUMBER	DESCRIPTION	UNIT
1024445FSCX	#10, 4 1/8" x 9 1/2"	500/BX

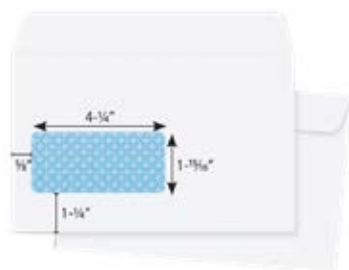

A T-4 ONE-WINDOW ENVELOPE

Standard Artline. Side seam. Window: size 1¹³/₁₆"x4¹/₄" (left: 5/8"; bottom: 1¹/₄").

ORDER NUMBER	DESCRIPTION	UNIT
1 9524480FSCNL	5 ³ / ₄ "x9"	500/BX
2 19032FSCNL	5 ³ / ₄ "x9"	25/PK

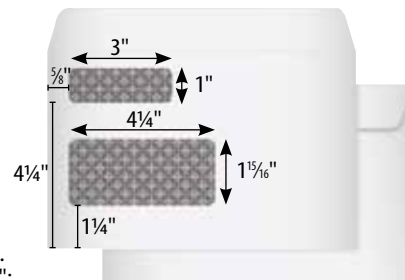

B T-4 TWO-WINDOW ENVELOPE

Standard Artline. Side seam. Top window: 1"x3" (left: 5/8"; bottom: 4³/₁₆"); bottom window: 1¹⁵/₁₆"x4¹/₄" (left: 5/8"; bottom: 1¹/₄").

ORDER NUMBER	DESCRIPTION	UNIT
1 9529480FSCNL	5 ³ / ₄ "x9"	500/BX
2 19031FSCNL	5 ³ / ₄ "x9"	25/PK

OFFICE SUPPLIES

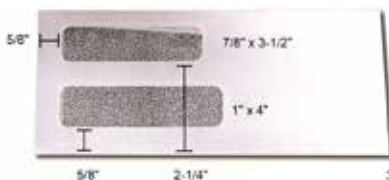

1

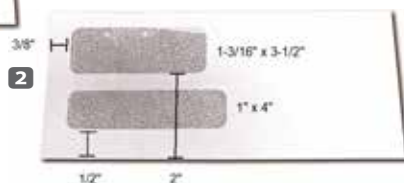

2



C SUPREMEX DOUBLE WINDOW PEEL & SEAL ENVELOPES

Self-seal flap. Lift flap and press for a secure seal. Security tint. Double window. White. FSC® Certified.

ORDER NUMBER	DESCRIPTION	UNIT
1 19028FSCNL	#8 ⁵ / ₈ , 3 ³ / ₈ "x8 ⁵ / ₈ "	500/BX
2 19027FSCNL	#9, 3 ⁷ / ₈ "x8 ⁵ / ₈ "	500/BX

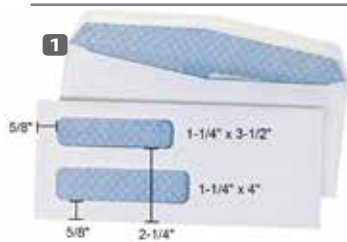

1

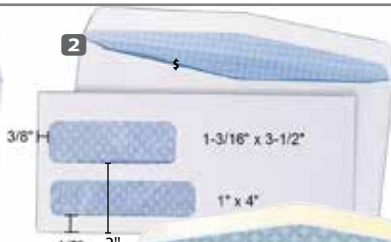

2

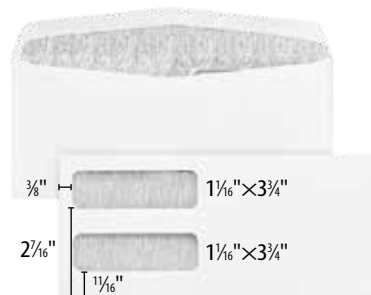

D SUPREMEX DOUBLE WINDOW ENVELOPES

Fully gummed flap for a secure seal. 24 lb. White.

ORDER NUMBER	DESCRIPTION	UNIT
1 24532FSCNL	#8 ⁵ / ₈ , 3 ³ / ₈ "x8 ⁵ / ₈ "	500/BX
2 24524FSCNL	#9, 3 ⁷ / ₈ "x8 ⁵ / ₈ "	500/BX
3 0929480FSCNL	#9, 3 ⁷ / ₈ "x8 ⁵ / ₈ "	500/BX



E SUPREMEX DOUBLE WINDOW ENVELOPES

Contains 30% post-consumer recycled paper. White.

ORDER NUMBER	DESCRIPTION	UNIT
19030FSCNL	#9, 4"x9"	100/PK



F SUPREMEX LASER/INKJET ENVELOPES

White wove envelopes with side seam. Heat resistant adhesive seal minimizes tacking from laser printers. FSC Certified®.

ORDER NUMBER	DESCRIPTION	UNIT
1070440FSCNL	#10, 4 ¹ / ₈ "x9 ¹ / ₂ "	500/BX

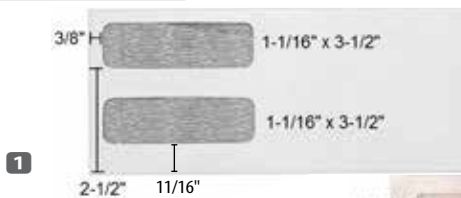

1

2

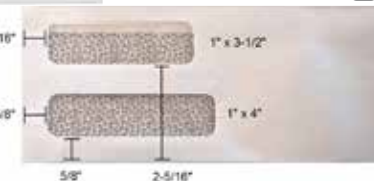

G ACCOUNTING SECURITY ENVELOPES

Double window. 24 lb. White.

ORDER NUMBER	DESCRIPTION	UNIT
1 QUA24483	#9, 4"x9"	500/BX
2 775	3 ³ / ₄ "x8 ³ / ₄ ", for QuickBooks cheques	500/BX
3 775SS	3 ³ / ₄ "x8 ³ / ₄ ", for QuickBooks cheques, self sealing	500/BX

Our Brand, YOUR Savings!



**A OP BRAND
NATURAL KRAFT
CATALOGUE
ENVELOPES**

Quality 24 lb open end catalogue envelopes. 100% post-consumer recycled material.



ORDER NUMBER	DESCRIPTION	UNIT
1 27811-10040	6½"×9½"	100/PK
2 27811-10050	9"×12"	10/PK
3 27811-10045	9"×12"	100/PK
4 27811-10060	10"×13"	10/PK
5 27811-10055	10"×13"	100/PK



**B SUPREMEX
NATURAL KRAFT
CATALOGUE ENVELOPES**

Open end. Contains 50% post-consumer recycled material. FSC® Certified.

ORDER NUMBER	DESCRIPTION	UNIT
24 LB.		
1 5900420FSC	5¾"×9½"	500/BX
2 6300420FSC	6½"×9½"	500/BX
3 6500420FSC	7½"×10½"	500/BX
4 6700420FSC	9"×12"	500/BX
5 7000420FSC	9½"×14¾"	500/BX
6 6800420FSC	10"×13"	500/BX
7 6900420FSC	11½"×14½"	500/BX
32 LB.		
8 7200320FSCNL	12"×16"	250/BX
9 7500320FSCNL	15"×18"	250/BX



**C SUPREMEX WHITE
CATALOGUE ENVELOPES**

Open end. 24 lb.

ORDER NUMBER	DESCRIPTION	UNIT
1 FG6532	9"×12"	100/PK
2 6300440FSCNL	6½"×9½", FSC® Certified	500/BX
3 6700440FSCNL	9"×12", FSC® Certified	500/BX



**D SUPREMEX
GOLDEN KRAFT
CATALOGUE ENVELOPES**

Open end. 24 lb.

ORDER NUMBER	DESCRIPTION	UNIT
1 6300430	6½"×9½"	500/BX
2 6700430	9"×12"	500/BX
3 7000430	9½"×14¾"	500/BX
4 6800430	10"×13"	500/BX
5 7300430	12"×15½"	250/BX
6 7500430	15"×18"	200/BX



**E SUPREMEX
PRESS TO SEAL
NATURAL KRAFT ENVELOPES**

Self sealing envelopes with Latex-closure. Press to seal, no moisture required. FSC Certified®.

ORDER NUMBER	DESCRIPTION	UNIT
1 19011FSCNL	5⅞"×9"	30/PK
2 19007FSC	9"×12"	25/PK
3 19009FSC	10"×13"	20/PK



**F SUPREMEX
RECYCLED CATALOGUE
ENVELOPES**

Press and seal latex closure. FSC® Certified. Contains a minimum of 50% post-consumer recycled material. 24 lb. Natural kraft.

ORDER NUMBER	DESCRIPTION	UNIT
1 18208FSC	9"×12"	100/PK
2 18210FSC	10"×13"	100/PK

Check online for the most current price.



A SPICERS POLY MAILERS

Combined strength and versatile courier envelope with bubble cushioning. Features hot melt self seal closure.

ORDER NUMBER	DESCRIPTION	UNIT
1 XPAK0	#0, 6¼"×9"	250/BX
2 XPAK1	#1, 7¼"×12"	100/BX
3 XPAK2	#2, 8½"×12"	100/BX
4 XPAK4	#4, 9½"×14½"	100/BX
5 XPAK5	#5, 10½"×16"	100/BX



C SELF SEAL POLY ENVELOPES

Poly envelopes are strong and tear resistant. Double perforation for easier opening. Open end. White.

ORDER NUMBER	DESCRIPTION	UNIT
1 139386	10"×13"	100/PK
2 139394	12"×15½"	100/PK
3 139360	14½"×19"	100/PK

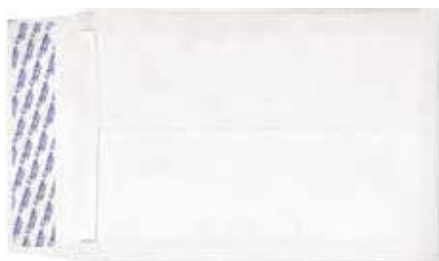

E SURVIVOR® TYVEK® CATALOGUE ENVELOPES

No-lick, instant-stick, convenient Redi-Seal® closure, made of DuPont™ Tyvek®; moisture and tear resistant.

ORDER NUMBER	DESCRIPTION	UNIT
1 QUAR1790	12"×15½"	100/PK
2 QUAR4500	10"×13"×1½", end expansion	100/PK



B BUBBLE MAILERS

Self-sealing shipping bags with ¾" plastic air bubble liner. Lightweight to reduce postage. FSC® certified.

ORDER NUMBER	DESCRIPTION	UNIT
1 EDGBM002	#000, 3¾"×7"	10/PK
2 EDGBM003	#00, 4⅞"×9"	10/PK
3 EDGBM004	#0, 6½"×9"	10/PK
4 EDGBM005	#1, 7"×11"	10/PK
5 EDGBM006	#2, 8¼"×11"	10/PK
6 EDGBM007	#3, 8¼"×13½"	10/PK
7 EDGBM008	#4, 9¼"×13½"	10/PK
8 EDGBM009	#5, 10¼"×15"	10/PK
9 EDGBM010	#6, 12¼"×18"	10/PK
10 EDGBM011	#7, 14"×19"	10/PK
11 ELSS0	#0, 6"×10"	250/BX
12 ELSS2	#2, 8½"×12"	100/BX
13 ELSS4	#4, 9½"×14½"	100/BX
14 ELSS5	#5, 10½"×16"	100/BX
15 ELSS6	#6, 12½"×19"	50/BX
16 ELSS7	#7, 14½"×20"	50/BX



D MERANGUE POLY MAILERS

Water and puncture resistant. Features 1¼" pullover lip with self-seal closure. Open end.

ORDER NUMBER	DESCRIPTION	UNIT
1 1024-0382-00-000	10"×13", assorted colours	50/PK
2 1024-0372-10-000	12"×15½", White	50/PK

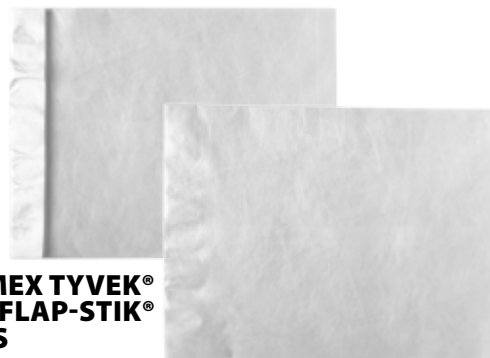

F SUPREMEX TYVEK® SURVIVOR FLAP-STIK® ENVELOPES

Tear, water and grease-resistant with peel-and-stick closure. Features a Flap-Stik® closure. Open end.

ORDER NUMBER	DESCRIPTION	UNIT
1 6718220T	9"×12"	100/PK
2 6818220T	10"×13"	100/PK



A SUPREMEX PEEL & SEAL KRAFT ENVELOPES

Removable strip provides clean, quick seal upon contact. FSC Certified®. Open-end. 24 lb. Natural.



ORDER NUMBER	DESCRIPTION	UNIT
1 19012FSC	9"×12"	100/PK
2 19013FSC	9"×13"	100/PK



B SUPREMEX COIN ENVELOPES

Open end. 24 lb. Golden kraft.

ORDER NUMBER	DESCRIPTION	UNIT
1 4100430	2¼"×3½"	500/BX
2 4200430	2½"×4¼"	500/BX
3 4600430B	3½"×6½"	500/BX

C QUALITY PARK® BULK MAIL ENVELOPES

Open end envelopes with Redi-Strip® closure for added security. Golden Kraft, 40 lb., 2" expansion.



ORDER NUMBER	DESCRIPTION	UNIT
1 QUA93334	9"×12"	25/PK
2 QUA93336	10"×13"	25/PK
3 QUA93338	10"×15"	25/PK



D CONFORMER® PAPERBOARD MAILERS

The eco-friendly 14 pt. white board Conformer® offers 360° perimeter protection – no shifting, no corner damage.

ORDER NUMBER	DESCRIPTION	UNIT
1 C2	9¾"×12¼", 5/8" expansion	EA
2 C4	11½"×13¾", 1½" expansion	EA



E SUPREMEX GUSSET ENVELOPES

Expands on all four sides. FSC® Certified. Contains a minimum of 50% post-consumer recycled content. 1" expansion. 32 lb. Natural Kraft.



ORDER NUMBER	DESCRIPTION	UNIT
1 6720320FSC	9"×12"	250/BX
2 6820320FSC	10"×13"	250/BX
3 8420320FSC	9½"×15"	250/BX



F SUPREMEX PEEL & SEAL GREETING CARD ENVELOPES

Self seal closure. 24 lb. White.



ORDER NUMBER	DESCRIPTION	UNIT
19029FSCNL	5¾"×8¾"	100/PK



G EDGE ENVELOPE INSERTS

Padding board used for mailing documents, photos and artwork without worry of bending. Contains a minimum of 90% post-consumer recycled material.



ORDER NUMBER	DESCRIPTION	UNIT
6413001	8½"×11"	25/PK

H SUPREMEX INVITATION ENVELOPES

Diagonal seam with V-Flap. 24 lb. White.



ORDER NUMBER	DESCRIPTION	UNIT
1 19000	4¾"×5½"	100/PK
2 19001	4¾"×6½"	100/PK
3 19002	5¼"×7¼"	100/PK

Envelopes – poly and inter-office



A VLB® FROSTED POLY ENVELOPES

Two-pocket, 13½"×9", with snap closure. Colours: **0** Charcoal, **1** Blueberry, **2** Strawberry, **3** Snow, **4** Grape, **5** Lime, **6** Yellow, **8** Tangerine.

ORDER NUMBER	DESCRIPTION	UNIT
20583-9097_	Specify colour	EA



B RECLOSABLE BAGS

With white block panel. 100 per pack.

ORDER NUMBER	DESCRIPTION	UNIT
1 RECPBWB223	2"×3"	PK
2 RECPBWB235	3"×5"	PK
3 RECPBWB246	4"×6"	PK
4 RECPBWB269	6"×9"	PK
5 RECPBWB2912	9"×12"	PK



C WINNABLE® POLY ENVELOPES

Transparent polypropylene. 1¼" expansion. Moisture and tear resistant. Reusable with button tie closure. EN-01 colours: **BE** Blue, **CR** Clear, **GN** Green, **PE** Purple, **RD** Red, **YW** Yellow. All other sizes available in clear only.

ORDER NUMBER	DESCRIPTION	UNIT
1 EN-01_	Letter/legal 9¾"×13¼", top opening, specify colour	EA
2 EN-02-CR	Letter, 8¾"×11¾", side opening	EA
3 EN-03-CR	Legal, 10¼"×14¾", side opening	EA
4 EN-04-CR	Cheque/voucher, 5¼"×9¾", side opening	EA



D SUPREMEX INTER-OFFICE ENVELOPES

Printed both sides. Press to seal. 32 lb. natural kraft. Bilingual. 10"×13".

ORDER NUMBER	DESCRIPTION	UNIT
1 10096FSC	Press to Seal	100/PK
2 19005FSC	Button and String closure	100/PK



E WINNABLE® POLY ZIPPER ENVELOPES

Easy to use zipper envelope with 1¼" expansion.

ORDER NUMBER	DESCRIPTION	UNIT
1 ENZ-510-CR	5"×10", cheque size	EA
2 ENZ-11-CR	10"×13", letter size	EA
3 ENZ-15-CR	10"×15", legal size	EA
4 ENZ-17-CR	11¾"×17¾", ledger size	EA



F WINNABLE® POLY INTER-OFFICE ENVELOPE

Clear front pocket holds routing sheets (2 pre-printed sheets included). Dark blue opaque poly for secure mailings; durable, waterproof and rip proof. Button and string closure; 1¼" expansion.

ORDER NUMBER	DESCRIPTION	UNIT
EN-12-DB	15"×10"	EA



A AVERY® MAILING SEALS

Permanent, clear mailing seals, 1" in diameter. Perforated for quick opening.

ORDER NUMBER	UNIT
67933-02355	75/PK



B UHU® STIC ENVELOPE SEALER

Securely seals over 1000 envelopes. Fast drying, washable, non-toxic and acid free. 21 g.

ORDER NUMBER	UNIT
9U99701	EA

C QUALITY PARK® ENVELOPE MOISTENER WITH ADHESIVE

Spill-proof plastic bottle; spring-valve non-clogging applicator. Secures over 1500 envelopes; dries quickly. 50 ml.



ORDER NUMBER	UNIT
QUA46065	EA

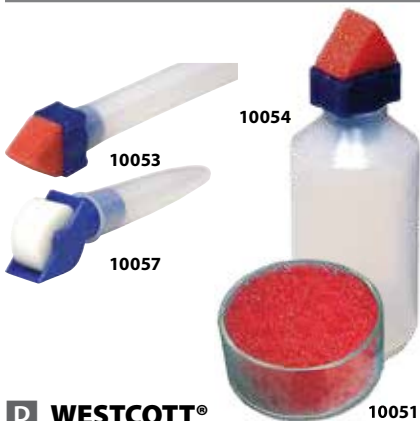

D WESTCOTT® ENVELOPE MOISTENERS

Make sealing envelopes and moistening stamps easy. Easy to fill.

ORDER NUMBER	DESCRIPTION	UNIT
1 65956-10053	Pencil style with sponge tip	EA
2 65956-10054	Bottle with sponge tip	EA
3 65956-10057	Pencil style with roller sponge	EA
4 65956-10051	Cup with sponge, 3"	EA



E WESTCOTT® SORTKWIK® FINGER TIP MOISTENER

Moistens fingers for an easy grip. Stainless, odourless and greaseless. 10g.

ORDER NUMBER	UNIT
65956-10050	EA



F WESTCOTT® ZIP STYLE LETTER OPENER

Plastic zip style letter opener with stainless steel blade for quick, clean and safe letter opening.

ORDER NUMBER	UNIT
65956-00297	EA



G WESTCOTT® FINGER TIPS

Non-vented.

ORDER NUMBER	DESCRIPTION	UNIT
1 65956-00710	Extra small	12/BX
2 65956-00711	Small	12/BX
3 65956-00712	Medium	12/BX
4 65956-00713	Large	12/BX
5 65956-00714	Extra large	12/BX
6 65956-00715	Assorted	12/BX



H WESTCOTT® STAINLESS STEEL LETTER OPENER

Precision ground stainless steel blade with sturdy, durable construction.

ORDER NUMBER	UNIT
65956-29349	EA



I WESTCOTT® KLEENEARTH® ANTIMICROBIAL LETTER OPENER

Comfortable contoured handle made from recycled plastic; precision ground stainless steel blade. Contains 70% recycled content with 30% post-consumer content.

ORDER NUMBER	UNIT
65956-14821	EA



A ADESSO 16" LOCKING CASH DRAWER

Classic steel construction with removable insert and coin case. 5 Bill and 5 coin case. Its sturdy structure with heavy duty ball bearing rollers is able to hold a maximum weight load of 50 kg. Adjustable dividers can be easily installed for custom storage space. 3-position lock with three functions; lock the drawer, unlock the drawer and unlock the mechanism and allow tray to release and open. Emergency release lever. Includes 2 keys. 16"W×3³/₁₆"D×16"H. Black.

ORDER NUMBER	DESCRIPTION	UNIT
1 MRP-16CD	Cash Drawer	EA
2 MRP-16CD-TR	Replacement Cash Tray	EA



B ROYAL SOVEREIGN® MANUAL CASH DRAWER

Ideal for small business use. Simply press the button on the cash drawer to open. 4 bill compartments with spring-loaded bill weights and 8 coin dividers (4 adjustable). Dual media slots for quick and secure storage of valuable items. Heavy duty, steel construction with non-slip rubber feet. Includes cash drawer with 2 keys, removable cash tray with locking lid and 2 keys.

ORDER NUMBER	DESCRIPTION	UNIT
1 RCRD-1616M	16.1"W×16.4"D×4"H	EA
2 RCRD-MB	Accessory steel mounting brackets	ST
3 RCRD-16T	Accessory tray with locking lid	EA



C SENTRY® SAFE DRAWERSAFE

Privacy key lock. Four-slot removable tray. Bolt-down hardware included. Durable enamel finish. Black.

ORDER NO.	DESCRIPTION	UNIT
DS-1	2 ⁷ / ₈ " H×6 ¹ / ₁₆ " W×7 ³ / ₂ " D	EA



D SENTRY® SAFE DELUXE SAFEBOX

Privacy key lock. Seven-slot removable tray. Spring loaded bill clips. Convenient fold-away handle. Rounded corners. Durable enamel finish. Black.

ORDER NO.	DESCRIPTION	UNIT
DCB-1	3 ³ / ₁₆ " H×11 ¹ / ₁₆ " W×9 ¹ / ₄ " D	EA



E ROYAL SOVEREIGN® TIERED TRAY DELUXE CASH BOX

Five compartment tiered coin tray. Separate storage compartment for coin rolls and supplies. 4 bill compartment with spring loaded bill weight. Includes lock with 2 keys. Grey.

ORDER NUMBER	DESCRIPTION	UNIT
CMCB-400	11 ¹ / ₁₆ " W×10"D×4"H	EA



CB-10



CB-12

F SENTRY® SAFE SAFEBOXES

Privacy key lock, convenient fold-away handle. Rounded corners. Durable enamel finish. Removable tray. Colour: Black.

ORDER NUMBER	DESCRIPTION	UNIT
1 CB-10	3 ¹ / ₄ " H×9 ⁷ / ₃₂ " W×7 ¹ / ₃₂ " D	EA
2 CB-12	3 ³ / ₁₆ " H×11 ¹ / ₁₆ " W×9 ¹ / ₄ " D	EA



**A ROYAL SOVEREIGN®
ELECTRIC BILL COUNTER
WITH COUNTERFEIT DETECTION**

Counts 1400 bills per minute. Canadian and American bills. Large back loading hopper holds up to 200 bills. Add mode shows cumulative total of all bills counted. Selectable batch counting from 1-999. Selectable Canada or US banknote mode for counting and counterfeit detection. Integrated LED display and bonus external display.

ORDER NUMBER	DESCRIPTION	UNIT
RBC-ES210-CA	12.2"D×10.2"W×7.0"H	EA



**B ROYAL SOVEREIGN®
COMPACT BILL COUNTER**

Also works as a Counterfeit Detector for US & Canadian paper currency, IDs and other official documents using Ultraviolet, Watermark or Magnetic security features. Counts up to 600 bills/minute, saving time and reducing losses due to human error. Loads up to 150 bills conveniently from the side, ensuring fast counting and an organized money stack for easy handling. Includes manual Add Mode. Uses Ultraviolet (UV), Watermark (WM), and Magnetic (MG) counterfeit detection to detect fake or suspicious currency - US paper bills only. Lightweight, portable design.

ORDER NUMBER	DESCRIPTION	UNIT
RBC-Quickcount	7 ²⁹ / ₃₂ "D×7 ⁶⁴ / ₆₄ "W×4 ¹³ / ₆₄ "H	EA



**C ROYAL SOVEREIGN®
ELECTRIC BILL
COUNTER WITH
VALUE COUNTING & COUNTERFEIT DETECTION**

Variable counting speed: 900, 1200, 1500 bills per minute. High capacity front loading hopper holds up to 500 bills. Add mode shows cumulative total of all bills counted. Selectable batch counting from 1-999. Selectable Canada or US banknote mode for counting and counterfeit detection. Selectable denomination for counting value. Integrated LCD display screen and bonus external display. Includes Date & Time and optional printing via RS232 interface (printer not included).

ORDER NUMBER	DESCRIPTION	UNIT
RBC-ED250-CA	9.5"D x 10.1"W x 9.2"H	EA



**D ROYAL SOVEREIGN®
DIGITAL TWO-ROW COIN SORTER**

With two rows for greater productivity with large quantities of coins; fast and accurate sorting of coins directly into wrappers. Sorts all Canadian coin denominations, from pennies to toonies. New motorized hopper coin feed; Patented internal anti-jamming device. LCD display shows dollar value and number of coins counted. Contemporary design.

ORDER NUMBER	DESCRIPTION	UNIT
FS2D-CA-N	8.4"D×8.4"W×9"H	EA



E MERANGUE® PAPER COIN WRAPPERS

Preformed, open at one end for easy loading. Can be used with electric coin sorters.

ORDER NUMBER	DESCRIPTION	UNIT
1 38829	5¢	36/PK
2 38831	10¢	36/PK
3 38832	25¢	36/PK
4 38833	\$1.00	36/PK
5 38834	\$2.00	36/PK
6 17036	Mixed	36/PK



F SELECTUM® COIN WRAPPERS

Clear plastic wrapper for accurate fit of predetermined amount of Canadian coins. Simplifies hand sorting and counting.

ORDER NUMBER	DESCRIPTION	UNIT
1 SL31444	5¢	10/PK
2 SL31445	10¢	10/PK
3 SL31446	25¢	10/PK
4 SL31447	\$1.00	10/PK
5 SL31448	\$2.00	10/PK



A MERANGUE® DEPOSIT POUCH WITH WINDOW

Heavy duty nylon bag with carry strap. Nylon zipper. Black; 12"×9¼".

ORDER NUMBER	UNIT
BP331B	EA



B MERANGUE® ALL-PURPOSE POUCH

Heavy-duty transparent PVC case; nylon zipper. 11½"×6".

ORDER NUMBER	UNIT
BP0098B	EA



C MERANGUE® DURABLE NYLON ZIPPERED BAG

Heavy duty construction; nylon zipper. Ideal for carrying stationery, paper money, coins and other collectables. Black. 6"×10¼".

ORDER NUMBER	UNIT
BP0798B	EA



D MERANGUE® JUMBO LOCKING ALL-PURPOSE POUCH

Heavy duty canvas case. Nylon zipper with padlock and 3 keys; 10"×13".

ORDER NUMBER	UNIT
BP945B-BLUE	EA

NEW!



E SENTRYSAFE® FIRE RESISTANT DOCUMENT BAG

For maximum protection, use in conjunction with a SentrySafe UL classified Fire Safe as part of a Total Fire Protection System. Convenient and portable bag with Four-Layer Protection, silicon-coated fiberglass exterior, aluminized fiberglass interior, fire resistant stitching and water resistant exterior coating. Dual closure includes snaps and a zipper for added protection. Large. Grey/Black.

ORDER NUMBER	DESCRIPTION	UNIT
FBWLZ0SSC	1½"×15"	EA



NEW!

F MASTER LOCK® LOCKING STORAGE BAG

Safely carry cash, jewelry and confidential documents. Features identification holder and card. Water resistant nylon. Includes built in high security lock and 2 keys. 11½"W×1 ¾"D×8 ⅜"H. Blue.

ORDER NUMBER	UNIT
7120D	EA



G BLUELINE® ADMISSION TICKETS

Roll of admission tickets numbered in sequence, with coupon. Assorted colours are Red and Blue. Bilingual.

ORDER NUMBER	DESCRIPTION	UNIT
1 69775-00590	Assorted	2000/RL
2 69775-00587	Assorted	1000/RL
3 69775-00542	Blue	2000/RL
4 69775-00546	Red	2000/RL

H AVERY® TICKETS WITH TEAR-AWAY STUBS

Perfect for raffles, dances, door prizes, company events. 65lb. card stock. Free templates include sequential ticket numbering. Printable both sides on laser or inkjet. Strong perforations on stubs. 10/sheet. White.

ORDER NUMBER	DESCRIPTION	UNIT
67933-16154	1¾"×5½"	200/PK



I SELECTUM® TALLY COUNTER

Chrome finish 4-digit counter.

ORDER NUMBER	UNIT
SL58099	EA

Business & Retail – price guns, fastener guns and tags

\$14.50



A GENERAL PURPOSE #106 ONE-LINE PRICE GUN

ORDER NO.	DESCRIPTION	UNIT
1	H06241 Pricing gun - 1 line, 6 characters/line	EA
2	H89891 Ink roller, black	5/PK
3	T06202 Labels - L21, permanent white	9000/PK
4	T06204 Labels - L21, removable white	9000/PK
5	T06206 Labels - L21, permanent radiant red	9000/PK



B GENERAL PURPOSE MIGHTY ONE ONE-LINE PRICE GUN

ORDER NO.	DESCRIPTION	UNIT
1	H09225 Pricing gun - 1 line, 6 large, 2 small char.	EA
2	H89891 Ink roller, black	5/PK
3	T09140 Labels - L25, permanent white	10500/PK
4	T92060 Labels - L25, removable white	10500/PK

12345678

\$14.98



\$11.95

\$14.99



C GENERAL PURPOSE #216 TWO-LINE PRICE GUN

1,250 labels per roll.

ORDER NO.	DESCRIPTION	UNIT
1	H06396 Pricing Gun - 2 lines, 8 characters/line	EA
2	H89892 Ink Roller, black	5/PK
3	T06276 Labels - L56, permanent white	12500/PK
4	T06277 Labels - L56, removable white	12500/PK
5	T06281 Labels - L56, permanent radiant red	12500/PK

1234567890

4.35 \$12.99



E GENERAL PURPOSE #210 TWO-LINE PRICE GUN

ORDER NO.	DESCRIPTION	UNIT
1	H06220 Pricing gun - 2 lines, 10 characters/line	EA
2	H89892 Ink roller, black	5/PK
3	T06298 Labels - L57, permanent white	10000/PK
4	T99901 Labels - L57, removable white	10000/PK

F PAPER BAGS

12"W×7"D×17"H. Brown.



ORDER NUMBER	UNIT
012029	500/CT



D MARK III STANDARD FASTENER GUN

ORDER NO.	DESCRIPTION	UNIT
1	954885 Fastener gun	EA
2	954887 Fastener needles, heavy duty	4/ST
3	954886 Fastener needles, standard	4/ST
4	000994 Fastener: Swiftach, paddle, 3" std, 50/dip	5000/BX
5	955106 Fastener: Swiftach, paddle, 1" std, 50/dip	5000/BX
6	000919 Fastener: Hook tach, gen. purp. 2", 50/dip	5000/BX



G MERANGUE® MARKING TAGS

Bright white or neon writing surface with knotted tie strings, attached.

ORDER NUMBER	DESCRIPTION	UNIT
1	1024-4051-00-000 Jewellery, 1 ³ / ₁₆ "×3 ³ / ₈ "	100/PK
2	1024-7291-00-000 2 ³ / ₄ "×1 ¹ / ₁₆ "	50/PK
3	1024-7311-00-000 1 ³ / ₄ "×1 ³ / ₃₂ "	50/PK
4	1024-7301-00-000 1 ¹ / ₂ "×1 ⁵ / ₁₆ "	50/PK
5	1024-4061-00-000 1 ³ / ₃₂ "×3 ³ / ₄ "	50/PK
6	1024-4041-00-000 Neon, 1 ³ / ₄ "×1 ³ / ₃₂ "	100/PK

Check online for the most current price.

327

OFFICE
SUPPLIES



A ICONEX™ THERMAL PAPER ROLLS

For machines using heat sensitive paper, debit/credit card machines.

ORDER NUMBER	DESCRIPTION	DIAMETER	UNIT
1 9078-0363	2¼"×30', mini Visa	1½"	100/CT
2 9078-0567	2¼"×50'	1½"	50/CT
3 9078-2495	2¼"×60',	1½"	100/CT
4 9078-0076	2¼"×85'	1½"	3/PK
5 9078-5061	2¼"×74'	1½"	50/CT
6 9078-0079	2¼"×165'	2½"	3/PK
7 9078-0568	2¼"×150'	2¾"	50/CT
8 9078-0065	3"×230'	3"	50/CT
9 9078-5087	3½"×200'	2¾"	50/CT
10 9078-0399	3½"×225'	2¾"	12/BX
11 9078-0565	3½"×230' (48 gm)	2¾"	50/CT
12 9078-0067	3½"×230'	3"	50/CT



D ICONEX™ FACSIMILE ROLL

Grade A, high quality, high sensitivity fax paper provides crisp, superior imaging on brilliant white background.

ORDER NUMBER	DESCRIPTION	UNIT
9073-0091	8½"×98'	RL



B ICONEX™ CREDIT/DEBIT CARD MACHINE CLEANING CARDS

Pre-saturated, disposable head cleaning card. Designed to safely and effectively remove all dirt, magnetic oxides and other contaminants from concealed magnetic heads, photo and optic sensors on all types of reader mechanisms.

ORDER NUMBER	UNIT
9435-0688	2/PK



C ICONEX™ PREMIUM GRADE A 16-LB. BOND PAPER ROLLS

High quality paper that gives a clear, easy to read impression.

ORDER NUMBER	DESCRIPTION	DIAMETER	UNIT
1 9074-0054	1¾"×150'	2¾"	10/PK
2 9074-0309	2¼"×150'	2¾"	5/PK
3 9074-0097	3"×150'	2¾"	50/CT



E ICONEX™ 2-PLY ROLLS

High quality carbonless copies; 2-ply, White/Canary.

ORDER NUMBER	DESCRIPTION	DIAMETER	UNIT
1 9077-0030	2¼"×100'	3½"	50/CT
2 9077-0012	3"×100'	3½"	50/CT

Business & Retail – literature displays and sign holders



A DEFLECTO® LITERATURE DISPLAY HOLDERS

Display a variety of literature at once, and save valuable counter space. Rounded edges offer a smooth, clean appearance. Countertop or wall mount units.

ORDER NUMBER	DESCRIPTION	UNIT
--------------	-------------	------

LEAFLET SIZE:

1	79916-77501 1 pocket, 4¼" W×7¾" H×3¼" D	EA
2	79916-77701 4 pockets, 4⅞" W×10" H×6⅞" D	EA
3	79916-77491 6 pockets, 9⅞" W×12⅞" H×6¼" D	EA

MAGAZINE SIZE:

4	79916-77001 1 pocket, 9¼" W×10¾" H×3¾" D	EA
5	79916-77301 3 pockets, 9½" W×12⅞" H×6¼" D	EA
6	79916-77441 4 pockets, 9⅞" W×13⅞" H×7" D	EA

B DEFLECTO® OUTDOOR LITERATURE BOX

Break-resistant and weather proof outdoor literature box with self-closing lid has a clearly visible front to showcase your letter, legal or A4 size materials. Fits a variety of posts and poles with included plastic ties and screws. 10" W×4½" D×13⅞" H.

ORDER NUMBER	UNIT
79916-79091	EA

C DEFLECTO® CLASSIC IMAGE® SIGN HOLDERS

For use on desks or countertops. Literature slides in from the side. Clear. Slanted design.



ORDER NUMBER	DESCRIPTION	UNIT
1	79916-69701 8½" W×11" H	EA
2	79916-66701 11" W×8½" H, (landscape)	EA

D DEFLECTO® DOUBLE-SIDED SIGN HOLDERS

Bottom-loading design, 2-sided display. For use on desk or countertop. Clear.



ORDER NUMBER	DESCRIPTION	UNIT
1	79916-69101 5" W×7" H, (portrait)	EA
2	79916-69201 8½" W×11" H, (portrait)	EA
3	79916-69301 11" W×8½" H, (landscape)	EA

E DEFLECTO® CUBICLE NAMEPLATE HOLDER

Top-loading insert; sealed on three sides to prevent literature from sliding out. Includes mounting clips, magnets and hook and loop tape.



ORDER NUMBER	DESCRIPTION	UNIT
587501	8½" W×2" H	EA

F DEFLECTO® INTERIOR IMAGE SIGN HOLDER

Adapts for tabletop, wall and cubicle mount applications. Anti-glare, protective sheet included; mounting hardware included.



ORDER NUMBER	DESCRIPTION	UNIT
89105	8½" W×2" H	EA

G DEFLECTO® CLASSIC IMAGE® WALL SIGN HOLDERS

Pre-drilled holes make wall mounting easy; top loading. Easily change out inserts without removing holder from wall. Clear.



ORDER NUMBER	DESCRIPTION	UNIT
1	79916-68301 11" W×8½" H (landscape)	EA
2	79916-68201 8½" W×11" H	EA

H DEFLECTO® SUPERIOR IMAGE® CURVED AND BEVELED EDGE SIGN HOLDERS

Premium quality, with green tinted edge that looks like glass. Signage securely floats between two plastic panels. Use vertically/horizontally; metal knobs unscrew to change literature & orientation. Accommodates inserts up to 8½"×11".



ORDER NUMBER	DESCRIPTION	UNIT
1	799693 Slanted with beveled edge, 10⅞" W×12⅞" H×3⅞" D	EA
2	799783 Curved, 10⅞" W×13⅞" H×3⅞" D	EA



A DEFLECTO® SUPERIOR IMAGE® WALL MOUNT BEVELED EDGE SIGN HOLDER

Premium quality, with a green tinted edge that looks like real glass. Securely floats signage between two plastic panels. Can be mounted vertically or horizontally; metal knobs unscrew to easily change literature and orientation.

ORDER NUMBER	DESCRIPTION	UNIT
691290	10 1/16" W x 12 3/16" H x 7/8" D, for 8 1/2" x 11" insert	EA



B SECO SNAP FRAME SIGN HOLDERS

This powder coated aluminum snap frame allows for quick and easy change out. No need to remove it off the wall when changing. Features a UV resistant, anti-glare PVC front sheet. Can be positioned portrait or landscape. Colours: **BLACK** Black, **SV** Silver.

ORDER NUMBER	DESCRIPTION	UNIT
1 SN8511-__	8 1/2" x 11"	EA
2 SN1114-__	11" x 14"	EA
3 SN1117-__	11" x 17"	EA

C AVERY® POST & PROTECT™ REMOVABLE SELF-ADHESIVE SIGN PROTECTOR SLEEVES

Removable adhesive strips on back of protector – sticks to most surfaces and removes cleanly every time. Ideal for walls, windows, doors, filing cabinets etc. Archival safe, acid-free and won't lift your print.



ORDER NUMBER	DESCRIPTION	UNIT
77711-78620	8 1/2" x 11"	10/PK

D AVERY® SELF ADHESIVE LAMINATING SHEETS

Create professional quality laminations without fussing with lamination machines. Easy-to-remove backing with grid for easy alignment and cutting. Permanent. Non-stick, polypropylene material is acid-free and archival quality. 7.5 mm. 9" x 12".



ORDER NUMBER	UNIT
1 77711-75293	10/PK
2 67933-76293	50/BX

E HEADLINE® CUSTOMIZABLE TENT SIGN

Double-sided heavy duty plastic directional sign designed for indoor or outdoor display; stable floor-standing angled stance. Includes two 8 1/2" x 11" bilingual inserts and two clear plastic overlays to protect your message from dirt and moisture. Black. Dimensions: 10 1/2" H x 25 1/2" H.



ORDER NUMBER	UNIT
10736-05694	EA

NEW!

F DEFLECTO® SUPERIOR IMAGE® SWIVEL SIGN HOLDER

Rotating display panels allow signage to be viewed on both sides. Clear panels with green tinted edges provide the look of real glass. 8 1/2" x 11".



ORDER NUMBER	UNIT
691590	EA



A HEADLINE® WINDOW AND DOOR SIGNS

For indoor or outdoor use. Styrene plastic.

ORDER NUMBER	DESCRIPTION	UNIT
1 83392-09381	Clock sign 5"×6", English	EA
2 83392-08393	Clock sign 5"×6", French	EA
3 83392-09382	Clock sign 7½"×9"	EA
4 10736-09385	Open/closed sign 11"×8", English	EA
5 10736-03826	Open/closed sign 11"×8", French	EA



B HEADLINE® BUSINESS HOURS SIGN KITS

Attach easily to any glass door or window surface. Available with long-lasting vinyl letters or removable static cling characters.

ORDER NUMBER	DESCRIPTION	UNIT
1 83392-09574	Double-sided, with vinyl characters, 10½"×14½"	EA
2 83392-09573	With static cling characters, 9"×11", English	EA
3 83392-08399	With static cling characters, 9"×11", French	EA

OFFICE SUPPLIES



D HEADLINE® INDOOR/OUTDOOR SIGNS

ORDER NUMBER	DESCRIPTION	UNIT
1 10736-04792	Exit (Glow in the Dark), 8"×12"	EA
2 10736-04793	Fire extinguisher (Glow in the Dark), 4"×13"	EA
3 83392-09300	Open/closed 2-sided, 8"×12"	EA
4 83392-09304	No smoking, 8"×12"	EA
5 83392-09305	Fire extinguisher, 8"×12"	EA
6 83392-09309	Business hours, 8"×12"	EA
7 83392-09312	For sale, 8"×12"	EA
8 83392-09902	For sale, 15"×19"	EA
9 83392-09909	Garage sale, 15"×19"	EA
10 83392-09914	Open/closed 2-sided, 14"×22"	EA



C HEADLINE® SIGN KITS

Indoor/Outdoor signs are extremely durable and visible. Includes a full set of black stick-on vinyl numbers. 8"×12". Durable styrene. English.

ORDER NUMBER	DESCRIPTION	UNIT
1 83392-09399	For Rent	EA
2 83392-09398	For Sale	EA



E HEADLINE® INTERNATIONAL SIGNS

Durable, self-adhesive vinyl, for indoor or outdoor use.

ORDER NUMBER	DESCRIPTION	UNIT
1 83392-09552	No smoking, 3"×3"	EA
2 83392-09602	No smoking, 6"×6"	EA
3 83392-09604	Handicapped, 3"×3"	EA
4 10736-08795	No vaping, 3"×3" No weed, 3"×3" and No smoking, 6"×6"	PK



A ROYAL SOVEREIGN® LED OPEN SIGN WITH BUSINESS HOURS

Bright LED lighting illuminates large durable acrylic sign. Simple peel and stick labels used to customize hours of operation. User selectable settings: ON, OFF or OPEN off with HOURS on. Can be seen from more than 100 feet away. Projected life of 80,000 hours. Includes hooks, chain and mounting screws. Power adapter and hours labels included.

ORDER NUMBER	DESCRIPTION	UNIT
RSB-1342E	English, 26.3" W×11.8" H×1.97" D	EA



C ROYAL SOVEREIGN® OPEN SIGNS

Bright LED illuminates large, durable, acrylic sign. User settings: ON, Continuous flashing, or OFF. Visible over 100 feet away. Projected life: 80,000 hours. Includes hooks, chain and mounting screws. Power adapter included.

ORDER NUMBER	DESCRIPTION	UNIT
1 RSB-1340E	English, 23½" W×12½" H×1¼" D	EA
2 RSB-1340F	French, 23½" W×12½" H×1¼" D	EA
3 RSB-1330E	English, 17" W×9¼" H×1½" D	EA
4 RSB-1330F	French, 17" W×9¼" H×1½" D	EA

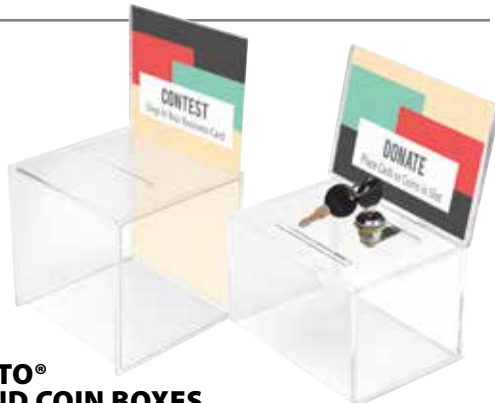

E DEFLECTO® BALLOT AND COIN BOXES

Transparent plastic box features sign holder to display your message. Great for raffle ticket or currency. Coin box includes lock.

ORDER NUMBER	DESCRIPTION	UNIT
1 79916-66001	8¾" W×15" H×8⅝" D	EA
2 79916-59076	Coin box, 6⅞" W×8⅞" H×4⅜" D	EA



B HEADLINE® CENTURY SERIES OPEN/CLOSED AND BUSINESS HOURS SIGNS

Made from heavy-duty plastic; large bold lettering. Business Hours sign includes 176 characters to designate hours of operation; easily mounts on window with suction cups. Also coordinates with and attaches to Open/Closed sign.

ORDER NUMBER	DESCRIPTION	UNIT
1 10736-04247	Business Hours, 14"×13"	EA
2 10736-04246	Open/Closed, 5"×13"	EA



D HEADLINE® CENTURY SERIES SIGNS

Stylish commonly used signs that will complement most office decors. Silver with black background. Includes easel for countertop display (3"×9" size) and double-sided adhesive tape for mounting to door or wall.

ORDER NUMBER	DESCRIPTION	UNIT
6"×9"		
1 10736-04249	Restroom	EA
2 10736-04248	Men/Women combo pack	2/PK
3 10736-04764	Accessible	EA
3"×9"		
4 10736-04757	No smoking	EA
5 10736-04760	Employees only	EA
6 10736-04761	Private	EA
7 10736-04763	Visitors must sign in	EA
8 10736-04758	No soliciting	EA

F HEADLINE® SECURITY CAMERA NOTICE SIGNS

Peel-'n'-Stick with plastic overlay to protect inserts. Indoor/Outdoor use. Includes two 3"×3" and one 6"×6" sign.

ORDER NUMBER	UNIT
10736-08198	EA



Boards & Easels – glass boards

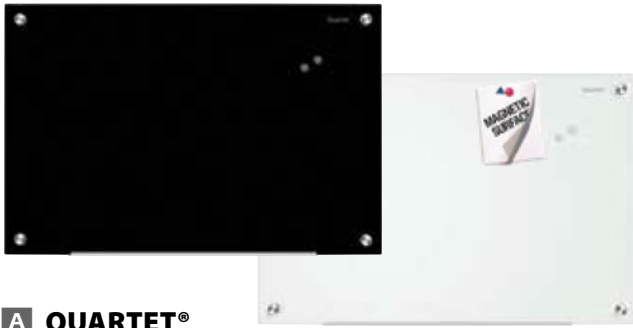

A QUARTET® INFINITY™ MAGNETIC GLASS BOARDS

Non-absorbent, tempered glass magnetic surface is easy to erase and will not stain or ghost. Ideal for heavy use in spaces with regular traffic. Includes mounting hardware and two high powered magnets. Limited 15-year warranty.

ORDER NUMBER	DESCRIPTION	UNIT
1	34138-20118 18"×24", Black	EA
2	34138-20119 24"×36", Black	EA
3	34138-20121 36"×48", Black	EA
4	34138-20122 48"×72", Black	EA
5	34138-20113 18"×24", White	EA
6	34138-20114 24"×36", White	EA
7	34138-20115 36"×48", White	EA
8	34138-20116 48"×72", White	EA



C QUARTET® INVISAMOUNT™ MAGNETIC GLASS DRY ERASE BOARDS

Tempered glass will not stain or ghost. Magnetic surface allows board to double as a display surface (high powered magnets required). Invisible mounting – hardware is hidden. Optional tray can be removed. Board sizes in modern 16:9 ratio wide format. Frameless board design blends seamlessly into any environment. Includes detachable, clip-on template to ease mounting process. Limited 20-year warranty.

ORDER NUMBER	DESCRIPTION	UNIT
1	34138-22330 22"×39"	EA
2	34138-22331 28"×50"	EA
3	34138-22332 42"×74"	EA
4	34138-22333 48"×85"	EA



E QUARTET® INFINITY™ MAGNETIC GLASS CUBICLE BOARD

Tempered glass will not stain or ghost. Magnetic surface (high powered magnets required). Includes a tray, dry erase marker and two magnets. Includes adjustable brackets to hang over cubicle walls, or use wall mounting hardware for wall use. Limited 15-year warranty.

ORDER NUMBER	DESCRIPTION	UNIT
34138-29984	18"×30"	EA



B QUARTET® INFINITY™ FROSTED DRY ERASE GLASS BOARDS

Non-absorbent, tempered glass magnetic surface is easy to erase and will not stain or ghost. Ideal for heavy use in spaces with regular traffic. Frameless board design blends seamlessly into any environment. Includes mounting hardware. Limited 15-year warranty.

ORDER NUMBER	DESCRIPTION	UNIT
1	34138-20108 24"×36"	EA
2	34138-20109 36"×48"	EA
3	34138-20111 48"×72"	EA



NEW!

D QUARTET® BRILLIANCE MAGNETIC GLASS DRY ERASE BOARDS

Tempered glass resists scratches and dents. Non-absorbent board is easy to erase and will not stain or ghost. Writing stands out on the high-contrast, true white glass. Includes accessory tray, 2 high-power glass board magnets, 1 Quartet® dry erase marker and pass-through mounting hardware. Limited 25-year warranty. White.

ORDER NUMBER	DESCRIPTION	UNIT
1	G22418W 18"×24"	EA
2	G23624W 24"×36"	EA
3	G24836W 36"×48"	EA
4	G24848W 48"×48"	EA
5	G27248W 48"×72"	EA
6	G29648W 48"×96"	EA



NEW!

F U BRANDS® GLASS MAGNETIC DRY ERASE CALENDARS

Magnetic tempered glass surface will never stain or ghost. Includes dry erase marker, magnet and mounting hardware. Lifetime warranty.

ORDER NUMBER	DESCRIPTION	UNIT
1	2342U00-01 20"×5½", Weekly	EA
2	2341U00-01 23"×12", Monthly	EA



Work. Collaborate. Create.



Anywhere.

Quartet® has the tools and solutions you need to be productive from anywhere. At the office, at home or on the go, Quartet® will help you work, collaborate and create.



Boards & Easels – whiteboards



A QUARTET® PRESTIGE® 2 TOTAL ERASE BOARDS

Durable surface resists ghosting and staining. Best suited for moderate use. Easy mounting system simplifies accurate installation. Plain board has a subtle grid pattern to guide writing. Graphite finish frame. Includes one Quartet® chisel tip dry erase marker. 20 year warranty.

ORDER NUMBER	DESCRIPTION	UNIT
1 CP32P2	24"×36" Calendar	EA
2 TEM544G	36"×48" Plain	EA
2 TEM547G	48"×72" Plain	EA



B QUARTET® CLASSIC PREMIUM PORCELAIN MAGNETIC BOARDS

DuraMax® porcelain surface will not scratch, dent, stain or ghost. Magnetic surface doubles as a bulletin board. Includes Easy Mount hanging system, repositionable marker tray and 4 dry erase markers. Anodized aluminium frame.

ORDER NUMBER	DESCRIPTION	UNIT
1 2543	24"×36"	EA
2 2544	36"×48"	EA
3 2547	48"×72"	EA
4 2548	48"×96"	EA



C QUARTET® CLASSIC MAGNETIC WHITEBOARDS

Durable platform for effective brainstorming, project organizing, note taking and more. Can be mounted horizontal or vertical. Nano-Clean technology prevents ink from penetrating the board surface. Streak-free with exceptional ghost and stain resistance. Aluminum frame. Includes accessory tray, one dry erase marker and mounting hardware. 5-year limited warranty.

ORDER NUMBER	DESCRIPTION	UNIT
1 SM531	18"×24"	EA
2 SM533	24"×36"	EA
3 SM534	36"×48"	EA
4 SM537	48"×72"	EA
5 SM538	48"×96"	EA



D QUARTET® EURO™ MAGNETIC WHITEBOARDS

Modern, Euro framed board with built-in mounting system and anodized satin aluminum frame.

ORDER NUMBER	DESCRIPTION	UNIT
1 64474-15523	18"×24"	EA
2 64474-15524	24"×36"	EA
3 64474-15525	36"×48"	EA
4 64474-15526	48"×72"	EA
5 64474-15527	48"×96"	EA

E QUARTET® PRESTIGE® 2 TOTAL ERASE® MAGNETIC WHITEBOARD EASELS

Surface resists staining and ghosting. Subtle grid pattern helps align writing. Painted steel surface doubles as a bulletin board. Full marker & accessory mantel. Mobile base with casters (3 locking).



ORDER NUMBER	DESCRIPTION	UNIT
1 ECM64P2	48"×72" Reversible	EA
2 ECM32P2A	36"×24"	EA



F QUARTET® MAGNETIC WHITEBOARDS

Aluminum frame with a painted steel magnetic surface.

ORDER NUMBER	DESCRIPTION	UNIT
1 34138-23230	24"×36"	EA
2 34138-23340	36"×48"	EA
3 34138-23460	48"×72"	EA
4 34138-23480	48"×96"	EA

NEW!



A MASTERVISION® MAGNETIC DRY-ERASE BOARDS

Lacquered steel Gold Ultra™ surface resists staining. Suitable for frequent use. Can be mounted horizontally or vertically. Aluminum frame with easy to mount four-corner system. Pen tray and mounting hardware included. 10-year limited warranty.

ORDER NUMBER	DESCRIPTION	UNIT
1 MA0307170	24"×36"	EA
2 MA0507170	36"×48"	EA
3 MA2707170	48"×72"	EA
4 MA2107170	48"×72"	EA

B QUARTET® FUSION NANO-CLEAN™ MAGNETIC WHITEBOARDS

Cutting edge and proprietary nano-technology with specially formulated hydrophobic properties allowing the user to cleanly and easily erase the board, even in extreme use environments. Aluminum frame. Painted steel surface. Includes mounting hardware and built-in accessory tray with a Quartet® dry erase marker. Limited 25-year warranty.

ORDER NUMBER	DESCRIPTION	UNIT
1 NA3624F	24"×36"	EA
2 NA4836F	36"×48"	EA
3 NA7248F-A	48"×72"	EA
4 NA9648F-A	48"×96"	EA



C QUARTET® DESKTOP GLASS™ DRY ERASE PRIVACY PANEL

Self-standing, double-sided glass surface keeps notes and ideas at your fingertips while providing personal workspace privacy. Will not stain or ghost. Built-in accessory channel for markers and pens. Includes one Quartet® dry erase marker and two Quartet® high power magnets. 15-year limited warranty.

ORDER NUMBER	DESCRIPTION	UNIT
34138-26909	17"×23"	EA

D QUARTET® DESKTOP GLASS™ DRY ERASE PAD

Designed to fit in the space between a keyboard and monitor. Desk accessory storage tray with convenient rail to hold markers/pens. Glass surface will not stain or ghost. Includes one Quartet® dry erase marker. 15 year warranty. 18"W×5¾"D×2⅝"H.

ORDER NUMBER	DESCRIPTION	UNIT
34138-29987	White	EA



E QUARTET® DESKTOP GLASS™ DRY ERASE EASEL

White glass desktop easel is infinitely reusable and replaces the need for scrap paper. Glass surface will not stain or ghost. Clipboard-style design allows dry erase desktop easel to double as a copy holder for letter or A4 size papers. Back of easel has a built-in storage slot to hold standard size sticky notes. Includes one Quartet® dry erase marker. 15 year warranty.

ORDER NUMBER	DESCRIPTION	UNIT
34138-29986	9"×11"	EA



F VIZTEX™ PORCELAIN MAGNETIC DRY ERASE BOARDS

Ceramic writing surface provides superior colour contrast and easy erasability. Magnetic surface will not scratch, stain or ghost under normal use. Aluminum frame. Includes 12" marker tray and full mounting kit.

ORDER NUMBER	DESCRIPTION	UNIT
1 FCVPM3624A	24"×36"	EA
2 FCVPM4836A	36"×48"	EA
3 FCVPM7148A	48"×71"	EA

Boards & Easels – whiteboards



A QUARTET® NON-MAGNETIC MELAMINE BOARDS

Durable whiteboards with Total Erase® surface protection to prevent ghosting and staining. Sleek, satin finish anodized aluminum frame; simple, flexible mounting system allows boards to be secured to wall in either orientation. Includes repositionable tray for convenient marker storage and one Quartet® dry erase marker.

ORDER NUMBER	DESCRIPTION	UNIT
1 S531	18"×24"	EA
2 S533	24"×36"	EA
3 S534	36"×48"	EA
4 S537	48"×72"	EA
5 S538	48"×96"	EA



C QUARTET® ESPRESSO™ DRY ERASE WHITEBOARDS

Painted steel board provides a durable, magnetic writing surface that doubles as a posting board. Includes clip-on dry erase marker and two magnets.

ORDER NUMBER	DESCRIPTION	UNIT
1 34138-03830	11"×17"	EA
2 34138-03831	17"×23"	EA
3 64474-15516	24"×36"	EA

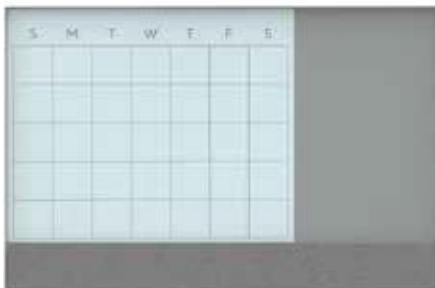

NEW!

E U BRANDS® 3-IN-1 MAGNETIC GLASS DRY DRASE COMBO BOARD

Magnetic tempered glass surface will never stain or ghost. Aluminum framed calendar, notes and bulletin board in one. Includes a liquid dry erase glass marker, magnet and tray. Lifetime warranty.

ORDER NUMBER	DESCRIPTION	UNIT
1 3196U00-01	17"×23"	EA
2 3197U00-01	23"×35"	EA



B QUARTET® MELAMINE DRY ERASE BOARDS

Melamine surface for use with dry erase markers. Dustless, non-glare surface. Aluminum frame with premounted hangers.

ORDER NUMBER	DESCRIPTION	UNIT
1 34138-32123	18"×24"	EA
2 34138-32230	24"×36"	EA
3 34138-32347	36"×48"	EA
4 34138-25146	48"×72"	EA
5 34138-25148	48"×96"	EA



D QUARTET® TIN BOARD

Smooth magnetic surface. Includes Quartet® dry erase marker, adhesive tape for hanging and 2 Quartet® magnets. 14"×14".

ORDER NUMBER	DESCRIPTION	UNIT
64474-15924	Marble print	EA



F QUARTET® PLASTIC FRAME MAGNETIC DRY ERASE BOARDS

Painted steel boards provide a durable, magnetic writing surface that doubles as a posting board (03869 and 03870 have a stainless steel surface). Assorted colour frames. Includes clip-on dry erase marker and two magnets.

ORDER NUMBER	DESCRIPTION	UNIT
1 34138-03799	8½"×11", Assorted	EA
2 34138-03869	8½"×11", Silver	EA
3 34138-03800	11"×14", Assorted	EA
4 34138-03870	11"×14", Silver	EA
5 34138-03801	11"×17", White	EA
6 34138-03803	17"×23", White	EA

Boards & Easels – combination boards



A QUARTET® COMBO BOARD

MDF wood wrap frame in neutral taupe colour. Magnetic dry erase surface with fabric bulletin strip at the bottom. Includes two gold push pins, two magnets and 1 Quartet® Rewritable marker.

ORDER NUMBER	DESCRIPTION	UNIT
64474-16035	17"×23"	EA



B QUARTET® COMBINATION BOARD

Clean and minimal finish complements today's popular styles. Features a taupe-coloured wood wrap frame. Includes two gold push pins and a Quartet® Rewritable marker.

ORDER NUMBER	DESCRIPTION	UNIT
64474-16040	14"×14"	EA



C MASTERVISION® DRY ERASE/FABRIC COMBO BOARDS

Durable thick textured fabric bulletin surface never shows pin holes. Metallic silver magnetic dry erase surface is ideal for home office, cubicles or small spaces. Includes mounting hardware. Grey frame.

ORDER NUMBER	DESCRIPTION	UNIT
MX04331608	18"×24"	EA



D QUARTET® COMBINATION BOARDS

A dry erase board and coloured cork board combined. Oak finish frame.

ORDER NUMBER	DESCRIPTION	UNIT
1 S553	24"×36"	EA
2 S554	36"×48"	EA



E QUARTET® ESPRESSO™ COMBINATION BOARD

Combination design offers two boards in one. Natural cork tack board half on the left; painted steel half on the right provides a durable, magnetic writing surface that doubles as a posting board. Includes clip-on dry erase marker and two magnets.

ORDER NUMBER	DESCRIPTION	UNIT
1 34138-03834	17"×23"	EA
2 64474-15517	24"×36"	EA



NEW!

F U BRANDS® PINIT™ 4-IN-1 MAGNETIC DRY ERASE COMBO BOARDS

Sleek aluminum profile creates a modern industrial look. Space for monthly and weekly planning, includes a section for notes. Full length cork strip adds bulletin board functionality. Includes dry erase marker, magnet and mounting hardware. 5-year warranty.

ORDER NUMBER	DESCRIPTION	UNIT
1 3890U00-01	17"×23"	EA
2 3891U00-01	23"×35"	EA



NEW!

G U BRANDS® PINIT™ 3-IN-1 MAGNETIC DRY ERASE COMBO BOARD

Premium magnetic dry erase surface. Great for cubicles or individual use. Full length cork strip adds bulletin board functionality without sacrificing writing space. Includes dry erase marker, magnet and mounting hardware. 3-year warranty.

ORDER NUMBER	DESCRIPTION	UNIT
388U00-01	16"×20"	EA

Check online for the most current price.

Boards & Easels – whiteboard accessories



Clean with just water, even permanent marker



A POST-IT® FLEX WRITE SURFACE

Instantly transform any work surface into a whiteboard. Sticks securely, removes cleanly. Use dry erase or permanent markers and clean with just water. 3-year limited warranty. White.

ORDER NUMBER	DESCRIPTION	UNIT
1 FWS3X2	2'x3' roll	EA
2 FWS4X3	3'x4' roll	EA
3 FWS6X4	4'x6' roll	EA
4 FWS8X4	4'x8' roll	EA



B POST-IT® DRY ERASE SURFACE

This new surface is easy to install and requires no tools. Stain-proof material erases cleanly every time. Smooth surface is easy to write on. Can be used to resurface old whiteboards and chalk boards instead of replacing them.

ORDER NUMBER	DESCRIPTION	UNIT
1 DEF3X2	36"×24"	EA
2 DEF4X3	48"×36"	EA
3 DEF6X4	72"×48"	EA
4 DEF8X4	96"×48"	EA
5 DEFSHEETS-3PK	7'×11" sheets	3/PK



NEW!

C QUARTET® PREMIUM MAGNETIC 3-IN-1 ERASER

Offers 3-in-1 cleaning for chalkboards and whiteboards. The felt pad is reversible for 2 cleaning surfaces and a 3rd microfiber surface offers deep cleaning. Eraser features a Spot-Erase Friendly Form. The oblong shape is excellent for spot erasing and successfully reaches into corners. 6½"W×2"D×1⅜"H.

ORDER NUMBER	UNIT
34138-41040	EA



NEW!

D U BRANDS® DRY DRAISE MAGNETIC SIDE-MOUNT ERASER

Magnetic feature allows it to be stored on any magnetic surface without the need for a tray. Side-mount with industrial felt. 6"×2⅓"W×1⅝"H.

ORDER NUMBER	UNIT
583F06-48	EA



NEW!

E U BRANDS® DRY DRAISE SHAG ERASER

The ultimate eraser for all dry draise surfaces. Chenille shag captures dry draise dust to keep your office clean. Washable. Small. 6⅔"W×3". Grey.

ORDER NUMBER	UNIT
582F06-16	EA



NEW!

F U BRANDS® DRY DRAISE MAGNETIC UTILITY CLIP

Ultra strong magnet enables cup to adhere to any magnetic surface. Store eraser, markers, notepad and more. 4⅞"W×1¼"D×4"H. White.

ORDER NUMBER	UNIT
495F04-12	EA



A QUARTET® MAGNETIC MICROFIBRE CLOTH WHITEBOARD ERASER

Provides exceptional cleaning of dry erase ink. Removes & eliminates residual dust during cleaning that normal dry erase markers leave behind. Magnetic holder. Washable. 12"×12". Black.

ORDER NUMBER	UNIT
64474-15802	2/PK

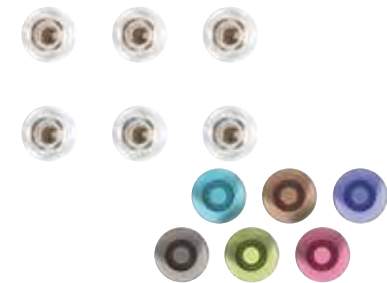

D QUARTET® GLASS BOARD MAGNETS

Optimized for glass, these magnets will hold up to 6 unstapled sheets per magnet.

ORDER NUMBER	DESCRIPTION	UNIT
1 85391	Clear	6/PK
2 85392	Assorted	6/PK



B EXPO® DRY ERASER

Soft washable whiteboard eraser.

ORDER NUMBER	UNIT
81505	EA



E MERANGUE MAGNETIC WHITEBOARD ACCESSORIES

Holds markers, erasers and cleaners & other supplies. Heavy duty magnets. Black.

ORDER NUMBER	DESCRIPTION	UNIT
1 1018-3171-20-000	Cup	EA
2 1018-3172-20-000	Caddy	EA



C ARTLINE™ WHITEBOARD MAGNETIC ERASER

Special magnetic eraser allows it to adhere to magnetic whiteboards so they are always accessible. 4¹³/₆₄"×2¹³/₆₄". Assorted colours.

ORDER NUMBER	UNIT
ERT-MM	EA



F CTHRU® ARTIST TAPE

Perfect for marking, colour coding and labelling. Durable and tear-resistant. 1/8" x 324". Assorted colours.

ORDER NUMBER	UNIT
CTAPE-1	6/PK



G QUARTET® CERAMIC MAGNETS

Round, for use on magnetic whiteboards.

ORDER NUMBER	DESCRIPTION	UNIT
1 34138-90200	1/2"	20/PK
2 34138-90301	3/4"	20/PK



H FILEMODE MAGNETIC TAPE

ORDER NUMBER	DESCRIPTION	UNIT
20583-61240	1"×120"	CD



I HEADLINE® GRAPHIC ART TAPE

Crepe paper self-adhesive border tape. Colours: 1 Black, 3 Red; specify colour.

ORDER NUMBER	DESCRIPTION	UNIT
1 83392-7316	1/16"W	RL
2 83392-7308	1/8"W	RL
3 83392-7304	1/4"W	RL



Our Brand, YOUR Savings!



B OP BRAND DRY ERASE MARKERS

Quick-drying markers with low odour, non-toxic ink provide bold colours. Easily wipes off. Chisel tip.

ORDER NUMBER	DESCRIPTION	UNIT
1 27811-50040	Black	10/BX
2 27811-50041	Assorted	4/PK

A EXPO® BRIGHT STICKS™ WET ERASE MARKERS

Wet erase markers with extra bright inks to appear fluorescent. Assorted.

ORDER NUMBER	DESCRIPTION	UNIT
14075	Bullet tip	5/ST



C EXPO® NEON™ WINDOW MARKERS

Neon coloured markers can be used on both black and white dry erase surfaces. Brilliant, highly visible colours, low odour, certified AP non-toxic ink for use in classrooms, offices and boardrooms. Five colours: Pink, Orange, Yellow, Green and Blue.

ORDER NUMBER	DESCRIPTION	UNIT
1752226	Bullet tip	5/PK



D QUARTET® GLASS BOARD MARKERS

Specifically designed to deliver bold colour on glass surfaces. Low odour, easy to erase markers are great for any environment. Bullet tip.

ORDER NUMBER	DESCRIPTION	UNIT
1 79553	Black	EA
2 79552-A	Assorted colours	4/PK
3 79559Q-CA	Assorted Neon colours	6/PK



F QUARTET® CLASSIC LOW ODOUR DRY ERASE MARKERS

DryGuard ink provides intense colour and smooth writing. Non-toxic, low odour. Features magnetic cap with eraser. Chisel point.

ORDER NUMBER	DESCRIPTION	UNIT
1 64474-59967	Black	EA
2 64474-59968	Blue	EA
3 64474-59969	Red	EA
4 64474-59970	Green	EA
5 64474-59971	Assorted	4/ST



E SHARPIE® CHALK MARKERS

Opaque chalk markers perfect for use on black boards, white boards and glass. Wipes off with a damp cloth. Medium tip.

ORDER NUMBER	DESCRIPTION	UNIT
1 2103010	White	2/PK
2 2103015	Red, Blue & Yellow	3/PK
3 2103006	Purple, Green & Orange	3/PK
4 2103011	White, Red, Blue, Yellow & Green	5/PK



G QUARTET® REWRITABLES™ DRY ERASE MARKERS

Low odour, non-toxic. Each marker has a cap-mounted eraser and a built-in magnet. Fine point.

ORDER NUMBER	DESCRIPTION	UNIT
1 26426-65931	Assorted Classic colours	6/ST
2 26426-66114	Assorted Vivid colours	6/ST



Boards & Easels – whiteboard markers



A EXPO® MAGNETIC DRY ERASE MARKERS WITH ERASER

Integrated magnet for convenient storage on metal surfaces and a handy eraser on the cap.

ORDER NUMBER	DESCRIPTION	UNIT
1 1944746	Fine point	4/ST
2 1944728	Chisel point	4/ST



C EXPO® 2-IN-1 DRY ERASE MARKERS

Dual-ended design for two colours in one marker. Low odour. Chisel point.

ORDER NUMBER	DESCRIPTION	UNIT
1 1944656	Assorted Fashion colours	4/ST
2 1944655	Assorted Business colours	4/ST



D PILOT V-BOARD MASTER WHITEBOARD MARKER

Marker with liquid ink and double pump system ensuring even and constant colour. Does not dry when uncapped. Refillable. Chisel tip. Contains a minimum of 91% recycled material. Black.

ORDER NUMBER	DESCRIPTION	UNIT
1 BG-WBMAVBMC-BK	Black	EA
2 WBS-VBM-BK	Refill	EA



E QUARTET® ENDURAGLIDE® DRY ERASE MARKERS

Low odour markers that last up to twice as long as standard dry erase markers. Patented 3-chamber barrel ensures even ink flow for consistent line quality. See-through barrel gauge; anti-roll cap.

ORDER NUMBER	DESCRIPTION	UNIT
1 34138-03478	Fine tip, Assorted	4/PK
2 34138-03476	Chisel tip, Black	4/PK
3 64474-02888	Chisel tip, Black	EA
4 64474-03963	Chisel tip, Blue	EA
5 64474-03964	Chisel tip, Red	EA
6 64474-00165	Chisel tip, Green	EA
7 34138-03479	Chisel tip, Assorted	4/PK
8 64474-59961	Chisel tip, Assorted	12/PK



8 Dry Erase Markers/Marqueurs Effaçables

B EXPO® LOW ODOUR DRY ERASE MARKERS

Designed for use on whiteboards. Fine, bullet or chisel point. Better erasing ink.

ORDER NUMBER	DESCRIPTION	UNIT	1-11	12
--------------	-------------	------	------	----

ULTRA FINE TIP

1 1871131	Black	EA		
2 1871133	Black, blue, red, green	4/ST		

FINE TIP

3 86001	Black	EA		
4 86002	Red	EA		
5 86003	Blue	EA		
6 86674K	Black, blue, red, green	4/ST		
7 2138430	Blue, red, green, purple	4/ST		
8 86601	Black, blue, red, green, orange, brown, purple, pink	8/ST		

BULLET TIP

9 82001	Black	EA		
10 82003	Blue	EA		
11 82074	Black, blue, red, green	4/ST		
12 2138471	Assorted colours	16/PK		

CHISEL TIP

13 80001	Black	EA		
14 80002	Red	EA		
15 80003	Blue	EA		
16 80004	Green	EA		
17 80074	Black, blue, red, green	4/ST		
18 80678	Black, blue, red, green, orange, brown, purple, pink	8/ST		
19 80699	Black, blue, red, green, orange, brown, plum, turquoise, light brown, purple, pink, lime	12/ST		
20 1921061	Black, blue, red, green, purple	36/BX		
21 1920940	Black	36/BX		

BUY MORE
SAVE MORE

NEW!

NEW!

OFFICE
SUPPLIES

Check online for the most current price.



A EXPO® LOW ODOUR ORGANIZER

Expo® eraser and Black, Green, Red, Blue, Orange and Brown Expo® chisel tip markers.

ORDER NUMBER	DESCRIPTION	UNIT
80556	Chisel tip	6/ST



B EXPO® LOW ODOUR STARTER SETS

Markers, cleaner and eraser. Better erasing ink.

ORDER NUMBER	DESCRIPTION	UNIT
1 80675	Fine point	5/ST
2 80653	Chisel point	4/ST

OFFICE SUPPLIES



C QUARTET® ENDURAGLIDE® ACCESSORY KIT

Includes 4 chisel tip assorted markers, eraser and cleaning solution.

ORDER NUMBER	DESCRIPTION	UNIT
34138-03922	Chisel point	ST



D STAEDTLER® DOUBLE-ENDED DRY ERASE MARKERS

Odourless dry erase ink designed for classrooms, offices and homes. Vivid colours for increased visibility and colour coding. Contains a minimum of 70% post-consumer recycled material. Assorted colours.

ORDER NUMBER	DESCRIPTION	UNIT
3010TB10LU	Chisel & bullet tip	10/PK



E QUARTET® 2-IN-1 FINE POINT ACCESSORY KIT

Dual tip marker with 2 bold colours in 1 marker. Includes 4 dual tip markers, eraser and cleaning solution. Assorted colour combinations: Black/Orange, Red/Pink, Blue/Purple, Green/Lime.

ORDER NUMBER	DESCRIPTION	UNIT
34138-32101	Fine point	ST



F EXPO® WHITEBOARD CLEANER

Cleans & refreshes whiteboards. For classroom and conference room use.

ORDER NUMBER	DESCRIPTION	UNIT
1 81803	256 mL	EA
2 81800	3.78 L Refill	EA
3 81850	50 Wipes	EA



G QUARTET® DRY ERASE BOARD CLEANERS

These cleaners are specially formulated for dry erase boards and are AP certified which makes them ideal for school use. 237mL.

ORDER NUMBER	DESCRIPTION	UNIT
1 551E	Cleaner & Conditioner	EA
2 34138-20070	Cleaner	EA



H QUARTET® GLASS BOARD CLEANER

This fast-drying, vinegar based formulation reduces streaks while also removing dry erase ink, dust and dirt. For best results, clean the board with an eraser first and then spray cleaner directly on the surface and wipe clean with a soft, dry cloth. 17 oz.

ORDER NUMBER	UNIT
562	EA

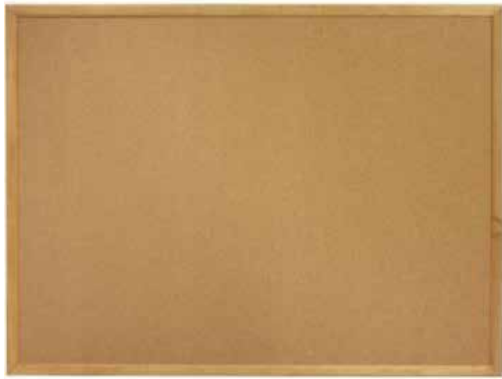

A QUARTET® WOOD FRAME CORK BULLETIN BOARDS

The posting surface will withstand repeated tacking. Ideal for low-frequency or low-traffic areas. Factory mounted hangers. Oak frame. Natural finish.

ORDER NUMBER	DESCRIPTION	UNIT
1 64474-15534	24"×36"	EA
2 64474-15535	36"×48"	EA



B QUARTET® ALUMINUM FRAME CORK BULLETIN BOARDS

Quality natural cork framed in aluminum. Ideal for low-frequency or low-traffic areas. Premounted hangers included.

ORDER NUMBER	DESCRIPTION	UNIT
1 34138-36124	18"×24"	EA
2 34138-36231	24"×36"	EA
3 34138-36348	36"×48"	EA
4 34138-35146	48"×72"	EA
5 34138-35148	48"×96"	EA



C QUARTET® EURO™ CORK BULLETIN BOARDS

Two-tone satin/grey frame with European styling. Made from high quality natural cork.

ORDER NUMBER	DESCRIPTION	UNIT
1 64474-15529	24"×36"	EA
2 64474-15530	36"×48"	EA
3 64474-15531	48"×72"	EA



D QUARTET® PRESTIGE® EURO™ BLACK EMBOSSED FOAM BOARDS

High-density, self-healing foam surface will not crumble or fade. Fibreboard backing maximizes holding power. Includes Quick Clips and Easy Mount hanging system. Aluminum frame with titanium finish. 10-year limited warranty.

ORDER NUMBER	DESCRIPTION	UNIT
1 B363T	24"×36"	EA
2 B364T	36"×48"	EA
3 B367T	48"×72"	EA



E WESTCOTT® PUSH PINS

Metal pins with Plastic tops. Colours: **42** Assorted, **61** Black, **65** Clear, **66** White.

ORDER NUMBER	DESCRIPTION	UNIT
65956-111_	Specify colour	100/BX



F WESTCOTT® MAP PINS AND FLAGS

Coloured ⅝" head, ½" metal pins or steel with plastic flags. Handy for marking and coding. Assorted.

ORDER NUMBER	DESCRIPTION	UNIT
1 65956-00174	Map pins	100/PK
2 65956-33005	Map flags	25/PK



G WESTCOTT® THUMB TACKS

Nickel Plated. ½". 100/box.

ORDER NUMBER	UNIT
65956-00522	100/BX

Boards & Easels – bulletin boards and accessories



A QUARTET® CORK BOARD

Clean and minimal finish. Features a taupe-coloured wood wrap frame and a geometric design printed on the cork.

ORDER NUMBER	DESCRIPTION	UNIT
64474-16039	16"×20"	EA



C U BRANDS® LINEN BULLETIN BOARDS

Premium linen surface on recycled industrial grade backing. For small home offices. Mounting hardware included. 3-year warranty. White frame.

ORDER NUMBER	DESCRIPTION	UNIT
1 2074U00-01	20"×30"	EA
2 2917U00-01	30"×40"	EA



E QUARTET® ENCLOSED BULLETIN BOARD

Full-length hinged doors have shatter-resistant acrylic panels and flush mount locks. Includes lock. Aluminum frame. 2-door.

ORDER NUMBER	DESCRIPTION	UNIT
2364	36"×48"	EA



B U BRANDS® CORK BOARDS

Recycled industrial grade backing. Self healing natural printed cork surface. Perfect for break rooms, factory floors, schools and offices. Mounting hardware included. 3-year warranty. Black frame.

ORDER NUMBER	DESCRIPTION	UNIT
1 026U00-01	17"×23"	EA
2 301U00-01	23"×35"	EA



D MASTERVISION® AYDA FABRIC BULLETIN BOARDS

Economic bulletin board that features a robust tackable surface. Easy 4-corner mounting system allows for vertical or horizontal installation. Includes mounting hardware and corner covers. Blue.

ORDER NUMBER	DESCRIPTION	UNIT
1 FA02439214	18"×24"	EA
2 FA03439214	24"×36"	EA
3 FA05439214	36"×48"	EA

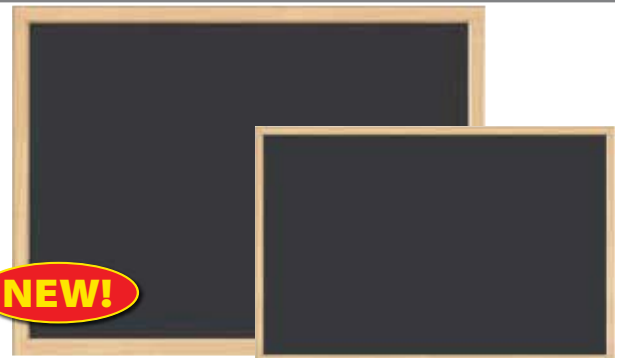

F U BRANDS® CHALKBOARD

Black chalk surface provides bold lay-down when used with white or coloured chalk. Great as menu boards for small restaurants and coffee shops. Birch MDF frame ensures long-lasting use. Includes liquid chalk marker and mounting hardware. 5-year warranty. Birch.

ORDER NUMBER	DESCRIPTION	UNIT
1 310U00-01	17"×23"	EA
2 3263U00-01	23"×35"	EA

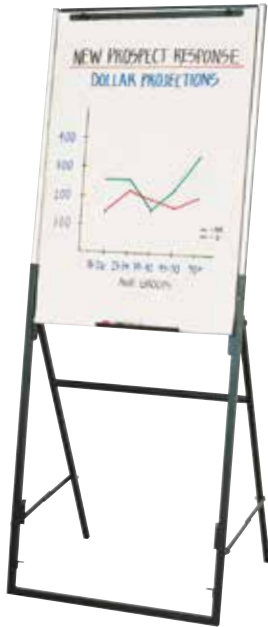

A QUARTET® FUTURA™ CONVERTIBLE EASEL

Modern design provides greater leg stability and allows conversion from floor to tabletop use. (67" to 40" H). Complete with pad retainer, pen ledge and white marker board. Easel pad not included.

ORDER NUMBER	DESCRIPTION	UNIT
351900	35"×26"	EA



B U BRANDS® DOUBLE SIDED MAGNETIC DRY ERASE MOBILE EASEL

Premium double-sided magnetic dry erase surface that flips easily for increased writing space. Painted steel provides a premium upgrade over a standard melamine surface, resists ghosting and erases easily. Solid locking casters provide easy mobility. Includes black dry erase marker, removable tray and magnet. 5-year warranty.

ORDER NUMBER	DESCRIPTION	UNIT
4535U00-01	36"×48"	EA



C QUARTET® ALUMINUM TELESCOPING EASEL

Collapsible, heavy gauge aluminum tripod frame with extendable telescoping legs. Supports up to 25 lbs. Optional pad holder available.

ORDER NUMBER	DESCRIPTION	UNIT
1 34138-39005	Easel	EA
2 34138-39020	Pad holder	EA



D QUARTET® BLACK MAGIC EASEL

Steel with telescoping legs to allow for height adjustment. Can be freestanding or on a tabletop. 67" high, black.

ORDER NUMBER	UNIT
34138-87700	EA



E QUARTET® PRESTIGE® 2 TOTAL ERASE® MAGNETIC WHITEBOARD EASEL

The 36"×24" Total Erase® whiteboard surface resists ghosting and staining. Lightly printed with a grid and is magnetic. Standard flipchart holders and extension arms on each side provide flexibility. Height adjustable from 67" to 77".

ORDER NUMBER	DESCRIPTION	UNIT
ECM32P2A	36"×24"	EA



F QUARTET® INSTANT EASEL

Lightweight and portable; creates an instant display area. Sturdy tripod weighs only 3 lbs. but supports up to 5 lbs. Maximum height 63", folds to 15".

ORDER NUMBER	UNIT
29E	EA

Boards & Easels – easel pads

A POST-IT® SUPER STICKY EASEL PADS

Super Sticky adhesive allows easel size padded sheets to be attached to virtually any surface. High quality paper is bleed resistant.



ORDER NUMBER	DESCRIPTION	UNIT
PLAIN		
1 577SS	15"×18", 20 sheets	EA
2 559	25"×30", 30 sheets	EA
3 559RP	25"×30", 30 sheets, recycled	EA
LINED		
4 561WL VAD 2PK	25"×30", 30 sheets	2/PK



B QUARTET® FLIP CHART PADS

Fine bond paper or economical newsprint pads. Contains a minimum of 15% post-consumer recycled material. Complete with pre-drilled mounting holes; 50 sheets per pad.



ORDER NUMBER	DESCRIPTION	UNIT
1 34138-89604	24"×36" Newsprint	2/PK
2 34138-89603	24"×36" Newsprint	5/BX
3 34138-89804	24"×36" Plain Bond	2/PK
4 34138-89803	24"×36" Plain Bond	5/BX
5 34138-89904	24"×36" Ruled Bond	2/PK
6 34138-89903	24"×36" Ruled Bond	5/BX
7 34138-89912	24"×36" Quad Ruled Bond	5/BX
8 34138-89600	20"×30" Plain Bond	5/BX



OFFICE SUPPLIES

C POST-IT® SUPER STICKY BIG NOTES

These notes encourage you to think and dream big. 30 Sheets per pad, 11"×11".



ORDER NUMBER	DESCRIPTION	UNIT
BN11	Bright Yellow	EA



E POST-IT® SELF STICK WALL PAD

No easel stand required. Wall pad mounts directly to the wall and removes cleanly. Great for brainstorming and project planning. Sheets resist marker bleed through. 20 sheets per pad. 20"×23".

ORDER NUMBER	DESCRIPTION	UNIT
566	Plain	2/PK

D POST-IT® SUPER STICKY TABLE TOP EASEL PAD

Requires no easel stand. Sheets resist bleed-through. Pad of 20 sheets, 20"×23".



ORDER NUMBER	DESCRIPTION	UNIT
563R	Plain	EA



F SHARPIE® FLIP CHART MARKER SETS

Designed for use with flip charts. Bright colours with no-squeak tip. No bleed through on flip chart pads. Low odour, AP certified non-toxic.

ORDER NUMBER	DESCRIPTION	UNIT
1 22474	Bullet tip	4/ST
2 22480PP	Bullet tip	8/ST



NEW!

A GEO WALL CLOCK

12/24-hour clock has black and red numbers. 12" diameter. Uses one "AA" battery (not included). Black.

ORDER NUMBER	UNIT
81298	EA



B BATES® 12/24 HOUR CLOCK

Large 12" diameter face with 12 and 24 hour times shown. Black. Requires one "AA" battery, not included.

ORDER NUMBER	UNIT
72803-47027	EA



C ORIUM® SILENT CLOCK

Analog clock featuring ABS anti-shock case with protective mineral glass face cover, quartz sweep movement, contrasting lined minute and hour markings, 30m readability with 2.8 cm black numbers on white background. 12" diameter. Uses one "AA" battery (included). 3-year warranty.

ORDER NUMBER	DESCRIPTION	UNIT
1 CEP11244	Black Rim	EA
2 CEP11247	White Rim	EA



D BATES® QUARTZ TRADITIONAL CLOCK

Large 12" diameter face. Precise quartz movement. Uses one "AA" battery, not included. Black.

ORDER NUMBER	UNIT
72803-47014	EA



E SWINGLINE® FASHION WALL CLOCK

High impact polystyrene. Glass lens and metal hands. Quartz sweep silent movement. 12" diameter. Uses one "AA" battery (not included).

ORDER NUMBER	DESCRIPTION	UNIT
1 64474-23001	Black	EA
2 64474-23000	Red	EA
3 64474-27007	Woodgrain	EA

NEW!

F BIOS PREMIUM STOPWATCH

High contrast digital display with backlight. Clock, date and alarm functions. Records real time and split times. Shock and water resistant case. Remembers first 30 laps and their split times. 1/100th second resolution up to 100 hours.

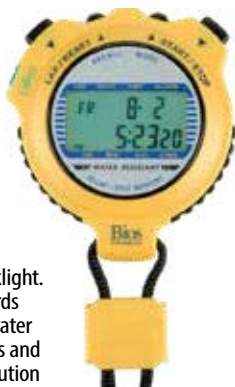

ORDER NUMBER	UNIT
FP603	EA

NEW!

G BIOS STOPWATCH

Large LCD that displays real time and records split times for accurate result. Clock, date and alarm function. Water resistant. Includes batteries and 48" lanyard.



ORDER NUMBER	UNIT
FP600	EA

NEW!

A ROYAL SOVEREIGN® LED DESK LAMP WITH USB AND NIGHT LIGHT

Modernly designed illuminous LED Desk Lamp offering great usability serving a range of operations. Features three adjustable light temperatures desk lamp, four colour night light, USB charging port, touch controls, and rotary dial for stepless dimming. 7"W×22"H×7"D. 450 Lumens. 8W. 3000K/4300K/6300K. Grey.



ORDER NUMBER	UNIT
RDL-110U	EA

NEW!

B ROYAL SOVEREIGN® LED DESK LAMP WITH WIRELESS CHARGING & UV-C STERILIZER

Stylish LED desk lamp provides adjustable light angle and brightness control. Includes convenient wireless charging of Qi enabled devices. UV-C drawer to safely and effectively sterilize 99.9% of germs and bacteria from smartphone and other items such as jewellery, keys, credit cards, etc. Features three adjustable light temperatures for warm, natural and bright light conditions. 17½"H. 500 lumens. 8W. 3000/5500K. White.



ORDER NUMBER	UNIT
RDL-1200QI-V1	EA

OFFICE SUPPLIES

C BOSTITCH® ADJUSTABLE CLAMP DESK LAMPS

Soft touch silicone finish. Fully flexible gooseneck for positional lighting. Uses only 5.5W to produce brilliant lighting at 500 lumens. Clamp version opens to 2".



ORDER NUMBER	DESCRIPTION	UNIT
1 VLED1800BK	Desk, 13¾" H	EA
2 VLED1800BK	Clamp, 14" H	EA

NEW!

D DAC® LED DESK LAMP ORGANIZER

Fully flexible silicone neck offers comfortable, anti-glare lighting where you need it. Featuring desktop storage and three-step brightness. 5.5 W. 380 Lumens. 5000K. 1 year manufacturer warranty. Black.



ORDER NUMBER	DESCRIPTION	UNIT
61754-02353	MP-329	EA

E MERANGUE DESK LAMP WITH CHARGER

Touch LED with three light temperature functions. Low, warm and high. Wireless charger built into the base. Multi-angle adjustment - swivels 180° at both base and neck and tilts on a 50° angle at the base. 13¾". 300 lumens. 5W. 3000K/4000K/6000K.



ORDER NUMBER	DESCRIPTION	UNIT
1 1011-0082-20-000	Black	EA
2 1011-0092-10-000	White	EA



F BOSTITCH® CLAMP ON MAGNIFIER LAMP

Uses up to 70% less energy. High powered LEDs, 3½" magnifier viewing area for detailed work. Tension control arm provides a 45° reach; fully adjustable lamp head. All metal construction. 6W 450 lumens.

ORDER NUMBER	DESCRIPTION	UNIT
VLED600	White	EA

G ROYAL SOVEREIGN® 2-IN-1 LED DESK AND CLIP-ON LAMP

Compact versatile lighting solution. Clip-on to desk or other surface or snap into included base to use as a free-standing lamp. Features touch sensor control with 3-step dimming. Adjustable flexible neck and the lamp head swivels to aim light. 15"H. 4W. 250 Lumens. 4300 K.



ORDER NUMBER	DESCRIPTION	UNIT
RDL-40-C	White	EA



H BOSTITCH® ADJUSTABLE DESK LAMP

Glare-free, shadow-free and flicker-free. Metal finish with acrylic accents. 14¼" high. Adjustable lamp for positional lighting. 300 lumens. 3W.

ORDER NUMBER	DESCRIPTION	UNIT
VLED1510	Black and chrome	EA



A BOSTITCH® MINIMALIST DIMMABLE LED DESK LAMP

Full-spectrum lighting mimics natural daylight and reduces eyestrain. Flicker-free light zone clear of shadows, halos and troublesome glares. Stepless dimming with slide touch control panel. Fully adjustable design. 6W. 300 lumens. 19" H. 2700 - 6500K. Black.

ORDER NUMBER	UNIT
VLED1826BLK-BOS	EA



B BOSTITCH® DIMMABLE GOOSENECK LED LAMP

Sleek design and ultra thin base. Adjustable gooseneck. Black silicon finish. 16½" high. 450 lumens. 5W. Built-in 1000 mAh-rechargeable lithium ion battery with USB adapter.

ORDER NUMBER	DESCRIPTION	UNIT
VLED1505	Black	EA



C BOSTITCH® GOOSENECK DESK LAMPS

Adjustable gooseneck for directional light exactly where you need it. Touch on/off with full dimming capability. Standard USB 2.0 port for device charging. 17"H. 450 lumens. 4.5W.

ORDER NUMBER	DESCRIPTION	UNIT
1 VLED1502-BK	Black	EA
2 VLED1502-RD	Candy Apple Red	EA



D ROYAL SOVEREIGN® 5-IN-1 LED DESK LAMP

Customizable lighting to set personal preference for reading, work, relaxation and sleep. Features fast charging wireless charging pad, USB fast charging output, Magnetic Apple Watch and AirPods charging base. 19 5/8"H. 800 Lumens. 8 watt. 2800K/3400K/4500K/5600K.

ORDER NUMBER	DESCRIPTION	UNIT
RDL-1100UQI	Black	EA



E ROYAL SOVEREIGN® GOOSE NECK LED DESK LAMP WITH USB

Adjustable flexible silicone goose neck and lamp head rotates to aim light where you need it. Features touch sensor controls, 3 selectable light temperatures, and stepless dimming. Intelligent memory restores last settings. Power on indicator light strip and 5V/2.0A USB. 15"H. 480 lumens. 8W. 3000K/4000K/6000K.

ORDER NUMBER	DESCRIPTION	UNIT
1 RDL-75U-B	Black	EA
2 RDL-75U-W	White	EA



F BOSTITCH® BATTERY OPERATED DESK LAMP

Compact and foldable. Full-spectrum lighting mimics natural daylight and reduces eyestrain. Three adjustable colour temperature modes for relaxing, reading and tasks. Includes 3' USB charging cord (no adapter). 4W. 150 Lumens. 3000-6500K. Built-in 1200mAh battery for mobile and emergency usage (lasts up to 3 hrs).

ORDER NUMBER	DESCRIPTION	UNIT
KT-VLED1810-WHITE	White	EA



G SAFCO® VAMP™ LED DESK LAMP

Style meets function. Multi-pivot flexible neck creates the right light for every work project. 8-step finger swipe dimming with a USB charging port. Warm or cool light settings. 550 lumens. 9W. 16¾"H.

ORDER NUMBER	DESCRIPTION	UNIT
1 1001WH	White	EA
2 1001SL	Silver	EA



FEATURE



A ROYAL SOVEREIGN® SWING ARM LED DESK LAMP WITH QI CHARGING

Modern design provides long reach with 3-way multi-angle rotation. Wireless charging of Qi enabled devices making it the ideal task lamp for home or office. Adjustable light colour temperature. Touch sensor controls and stepless dimming. Intelligent memory restores last settings when lamp is turned on. 10W. 550 lumens. 32"H. 3000K/4000K/6000K. Black.

ORDER NUMBER	UNIT
RDL-150Qi	EA



B ROYAL SOVEREIGN® MULTI-ANGLE LED DESK LAMP WITH QI CHARGING

Multi-angle adjustment and temperature lighting makes this lamp truly customizable. Touch sensor controls, adjustable 3 light temperatures, and stepless dimming. Intelligent memory restores last settings. 17"H. 10W. 600 lumens. 2700K/4300K/6300K.

ORDER NUMBER	DESCRIPTION	UNIT
1 RDL-140QI-B	Black	EA
2 RDL-140QI-W	White	EA

OFFICE SUPPLIES



C BOSTITCH® OFFICE SWING ARM LED FLOOR LAMP

Ideal for offices, lounge areas and communal spaces. Flicker-free zone clear of shadows, halos and glares. Fully adjustable swing arm easily positions for focused and directional lighting. Weighted base for stability. 9W. 700 lumens. 72" high. 4700 K. Black.

ORDER NUMBER	UNIT
VLF100F	EA

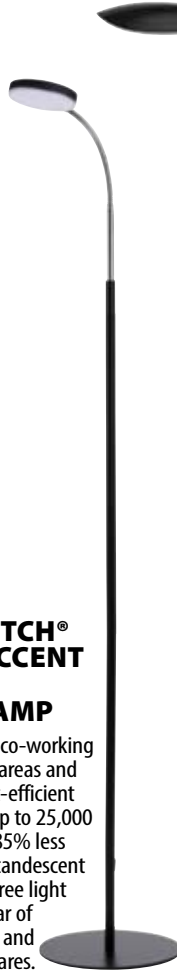

D BOSTITCH® TASK + ACCENT LED FLOOR LAMP

Ideal for desks, co-working spaces, lounge areas and more. Uses cost-efficient LEDs that last up to 25,000 hours and use 85% less energy than incandescent lamps. Flicker-free light zone that is clear of shadows, halos and troublesome glares. Flexible neck to easily position light zone. Full-spectrum lighting mimics natural daylight and reduces eyestrain. 52" high. 4.5W. 450 lumens. 6500K. Black.

ORDER NUMBER	UNIT
VLED1800F-BLK-BOS	EA

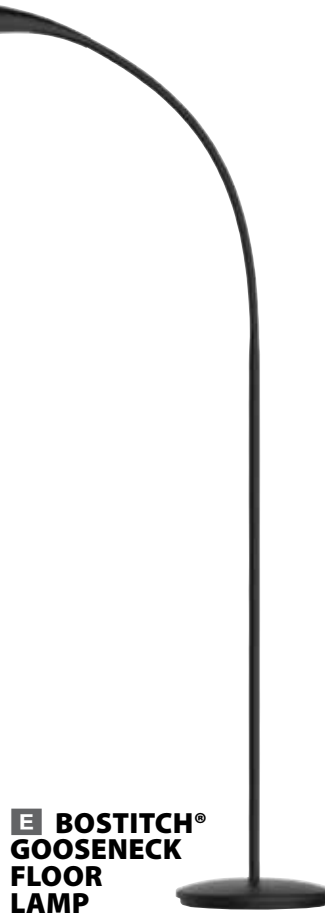

E BOSTITCH® GOOSENECK FLOOR LAMP

A great pairing with the VLED1502-BK LED desk lamp. Silicone flexible arm provides light where you need it. Heavy weighted base provides great stability. Convenient foot pedal to turn it on and off. 800 lumens, 12W. 72" high. Black.

ORDER NUMBER	UNIT
VLED1502-BKF	EA



NEW!

F DAC® FLOOR LAMP WITH ROTATING HEADS

Modern and sleek design and metal construction. Featuring touch control on each lamp head with 3 dim levels. Two 360° rotating heads. 55"H high. 10 W. 900 Lumens. 3000K. 1-year warranty. Black.

ORDER NUMBER	UNIT
61754-02342	EA

Arts & Education

Display Boards & Lettering.	354-355
Canvas & Art Pads.	356-361
Art & Craft Paper.	362-364
Art & Craft Supplies.	365-369
Markers, Crayons, Pastels & Pencils	370-379
Paint.	380-385
Calligraphy.	386-387
Classroom Organizers.	388-390
Classroom Essentials.	391-400



A HEADLINE® EZ BLOCK™ ADHESIVE LETTERS AND NUMBERS



Permanent waterproof letters and numbers are designed for indoor and outdoor use. Black on White.

ORDER NUMBER	DESCRIPTION	UNIT
1 83392-02570	1"	EA
2 83392-02571	2"	EA



C CTHRU® ARTIST TAPE

Perfect for marking, colour coding and labelling. Durable and tear-resistant. 3/8"×324". Assorted colours.

ORDER NUMBER	UNIT
CTAPE-1	6/PK



E HEADLINE® GRAPHIC ART TAPE

Crepe paper self-adhesive border tape. Colours: 1 Black, 3 Red; specify colour.

ORDER NUMBER	DESCRIPTION	UNIT
1 83392-7316	1/16" W×324" L	EA
2 83392-7308	3/8" W×324" L	EA
3 83392-7304	1/4" W×324" L	EA



NEW!

G OLFA® AK-1/5B GRAPHIC ART KNIFE

Craft knife that delivers the stability and ease of a pen with the precise cuts of a knife. Features molded handle. Made from carbon tool steel. Precision blade with a 23-degree angle is perfect for both consumer and industrial graphics applications. Includes 5 replacement blades. Yellow.

ORDER NUMBER	DESCRIPTION	UNIT
1 9167	#11 blades	5/PK
2 9153	Craft knife	EA



B HEADLINE® SELF-ADHESIVE VINYL LETTERING

Helvetica typestyle. Colours: 1 Black, 2 White. Specify colour.

ORDER NUMBER	DESCRIPTION	UNIT
1 83392-3174	3/4" Capitals and numerals	EA
2 83392-3181	1/2" Capitals and numerals	EA
3 83392-3191	3/4" Capitals and numerals	EA
4 83392-3111	1" Capitals and numerals	EA
5 83392-3121	2" Capitals and numerals	EA
6 83392-3131	3" Capitals	EA
7 83392-3133	3" Numerals	EA



D HEADLINE® REUSABLE PAINT AND LETTERING STENCILS

Capitals and numerals. Gothic style.

ORDER NUMBER	DESCRIPTION	UNIT
1 83392-00101	1"	EA
2 83392-00102	2"	EA
3 83392-00103	3"	EA
4 83392-00104	4"	EA
5 83392-00105	5"	EA
6 83392-00106	6"	EA
7 83392-00107	8" Numerals	EA
8 83392-00108	8" Capitals	EA



F X-ACTO KNIVES

For precise, fine cuts. #1 knife with a #11 blade.

ORDER NUMBER	DESCRIPTION	UNIT
1 XWA211E	#11 blades	5/CD
2 XWA3201E	Slim style knife	EA
3 X3601Q3	Slim style knife with safety cap	EA

H MERANGUE CUTTING MATS

Provides a self-healing, smooth cutting surface. Three layers extend life of mat. PVC-free. Green.

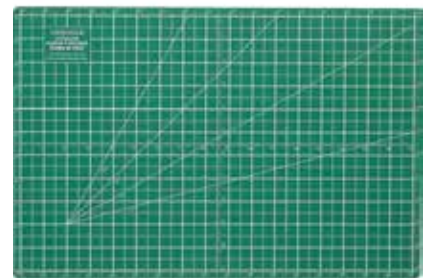

ORDER NUMBER	DESCRIPTION	UNIT
1 1026-0611-00-000	12"×18"	EA
2 1026-0621-00-000	18"×24"	EA

NEW!

A UCREATE® COATED POSTER BOARD

Made from high-strength, bleached kraft base stock and is coated and coloured on both sides. Coating provides a durable smooth finish that does not bleed when moistened and can be used for a variety of applications. Fade resistant and acid free. 22"×28". Regular colours: **80** Red, **83** Yellow, **84** Green, **86** Blue, **87** Lt. Blue, **94** Black. Neon colours: **07** Hot Pink, **08** Hot Orange, **09** Hot Lemon.

ORDER NUMBER	DESCRIPTION	UNIT
1 P53 -1	12 pt. Regular colours	EA
2 P54 -1	12 pt. Neon colours	EA
3 P5460-7	14 pt. White	EA



C ITOYA® PROFOLIO MIDTOWN BAG

Made of soft, durable, felt material – it's perfect for carrying large format sketchpads, canvases, presentation boards, artwork, posters, and frames. Extremely durable one-piece construction reliable. Blue stitching on black felt.

ORDER NUMBER	DESCRIPTION	UNIT
1 MD-1421-BKBU	14"×21"	EA
2 MD-1723-BKBU	17"×23"	EA
3 MD-2231-BKBU	22"×31"	EA

E ITOYA® ART PROFOLIO®

Features a durable polypropylene cover; crystal-clear, top-loading pocket sheets that resist moisture and dust; and quality crafted, thick-gauge, black mounting paper. Completely acid-free and PH-neutral. It's archival safe for all storage needs, from artwork to photography and film. The display book comes with 24 sleeves (48 views).

ORDER NUMBER	DESCRIPTION	UNIT
1 EV-12-9	9"×12"	EA
2 EV-12-12	11"×17"	EA



B READI-BOARD FOAM BOARD

Lightweight board that cuts crisply and holds a cleancut edge. Suitable for mounting artwork; thickness: 3/16".

ORDER NUMBER	DESCRIPTION	UNIT
1 SL99301	Black, 20"×30"	EA
2 SL99300	White, 20"×30"	EA



NEW!

D PACON® PRESENTATION BOARDS

Tri-fold, corrugated display boards used for projects, booths, science fairs and all types of displays. Coloured front and Natural Kraft back. Recyclable. 36"×48" open, 36"×24" with two fold-over flaps of 12"×36" closed.

ORDER NUMBER	DESCRIPTION	UNIT
1 P3762	Double wall-Heavy duty, 6 mm, White	EA
2 P3763	Single wall, White	EA
3 P3766	Black	EA



F VLB® PRESENTATION BOOKS

Archival book for art and photographs; lets you add to or change your presentation without glue or tape. With 24 crystal clear, archival quality, non-ink-transferring polypropylene pocket pages. Each page provides two viewing sides and includes an acid-free, archival quality black backing paper insert. Poly cover with piping.

ORDER NUMBER	DESCRIPTION	UNIT
1 20583-97840	8½"×11"	EA
2 20583-97820	11"×14"	EA
3 20583-97810	11"×17"	EA

Arts & Crafts — easels and canvas



A SIMPLY® WOODEN TABLE EASEL

For canvas sizes up to 22".

ORDER NUMBER	UNIT
835200010	EA

B WINSOR & NEWTON® CLASSIC STRETCHED CANVAS

12.3 oz. cotton canvas with highly pigmented titanium dioxide Gesso primer for superior coverage and performance. Warp resistant kiln-dried solid wood stretcher bars base. Hand-stretched, back-stapled canvas with folded, uncut corners. Archival acid free canvas is ideal for use with oils or acrylics.

ORDER NUMBER	DESCRIPTION	UNIT
1	6201041 5"×7"	EA
2	6201045 8"×10"	EA
3	6201049 9"×12"	EA
4	6201006 11"×14"	EA
5	6201008 12"×16"	EA
6	6201013 14"×18"	EA
7	6201016 16"×20"	EA
8	6201019 18"×24"	EA
9	6201022 20"×24"	EA
10	6201026 24"×30"	EA
11	6201031 30"×40"	EA



C SIMPLY® ALUMINUM FIELD EASEL

Portable easel with carrying bag. Easel holds canvas sizes up to 33". Telescopic legs

ORDER NUMBER	UNIT
835300050	EA

D WINSOR & NEWTON® CANVAS BOARDS

Canvas laminated onto high quality boards of excellent stability. Hand stretched for correct tension; triple coated — one coat of acid free triple and two coats of highly pigmented primer.

ORDER NUMBER	DESCRIPTION	UNIT
1	6224100 4"×6"	EA
2	6224103 8"×8"	EA
3	6224258 8"×10"	EA
4	6224109 9"×12"	EA
5	6224261 11"×14"	EA
6	6224264 12"×16"	EA
7	6224266 14"×18"	EA
8	6224270 16"×20"	EA
9	6224278 18"×24"	EA
10	6224136 24"×30"	EA



E LIQUITEX® GESSO ACRYLIC MEDIUM

Excellent ground for acrylic and oil paints. Clear gesso sizes and primes while maintaining the original appearance of the surface. For canvas, paper, wood, or any clean, porous, non-oily surface. White gesso is fast drying and opaque



ORDER NUMBER	DESCRIPTION	UNIT
1	7608 237 mL, clear	EA
2	7632 946 mL, clear	EA
3	5308 237 mL, white	EA
4	5332 946 mL, white	EA

F CANSON® FOUNDATION CANVAS PAPER

Features a bleed proof, canvas like textured paper that is ready for oil or acrylic paint without priming or preparation. 136 lb. 10 sheets per pad.



ORDER NUMBER	DESCRIPTION	UNIT
100510841	9"×12"	EA



A CANSON® XL® OIL & ACRYLIC PAD

XL® sheets are bleed proof, canvas-like textured paper that is ready to use with oil or acrylic without priming or preparation. Glue-bound pad contains 24 acid-free 136lb. natural white sheets.

ORDER NUMBER	DESCRIPTION	UNIT
400026824	9"×12"	EA



B CANSON® PLEIN AIR ARTBOARDS

Pads contain 10 rigid art boards laminated to different art mediums. Glued one side with convenient fold over cover. 9"×12". 10 boards/pad.

ORDER NUMBER	DESCRIPTION	UNIT
1 400061734	Illustration paper: ultra-smooth, extra white with no optical brighteners, brilliant for ink, marker, felt tip pens, and pencils	EA
2 400061737	Canva: primed for oil paint, oil sticks, oil pastels, or acrylics. Canvas-like texture treated with a high performance barrier to evenly absorb oil, bonding agents, and water	EA
3 400061698	Watercolour paper: Montval cold press, watercolour paper for wet media	EA



C CANSON® XL® WATERCOLOUR PADS

A cold press textured paper for a variety of techniques. The durable surface stands up to repeated washes. 30 sheets. 140lb. 9"×12".

ORDER NUMBER	DESCRIPTION	UNIT
1 100510941	Fold over	EA
2 400068375	Side wirebound	EA



D BIENFANG® #538 PH NEUTRAL WATERCOLOUR PAPER

Washes will not bleed on this heavyweight 140lb, acid-free paper. Student grade pH neutral watercolour paper is excellent for watercolours and mixed media. Glue-bound pads or loose sheet packs.



ORDER NUMBER	DESCRIPTION	UNIT
1 R285421	9"×12", 15 sheets/pad	EA
2 R285431	11"×15", 15 sheets/pad	EA
3 285461	18"×24"	15/PK
4 285257	18"×24"	100/PK

E CRAYOLA® MARKER & WATERCOLOUR PAD

Heavy bright white paper for colouring and painting fun. Pad of 60 sheets.



ORDER NUMBER	DESCRIPTION	UNIT
61-2009	9"×12"	EA



F PRANG® FINGERPAINT PAPER

Extra strong glossy white paper, coated on both sides. Resists running, smearing and bleeding.

ORDER NUMBER	DESCRIPTION	UNIT
1 P0073620	11"×16"	100/PK
2 P5316	16"×22"	100/PK

A BIENFANG® #601 TAKE ME ALONG SKETCH BOOKS

Wire-bound sketchbook containing 100 sheets of light weight, general purpose paper (50lb). Great for learning new techniques with pencil and pen. Acid free.



ORDER NUMBER	DESCRIPTION	UNIT
1 R237104	5½"×8½"	EA
2 R237117	8½"×11"	EA
3 R237130	11"×14"	EA

B CANSON® XL® SKETCH PADS

Medium tooth paper that erases cleanly. The wire bound pads have micro perforated true size sheets. 100 sheets. 50lb. 9"×12".



ORDER NUMBER	DESCRIPTION	UNIT
1 100510939	Top bound	EA
2 400061860	Side bound	EA

C STUDIO PRO™ SKETCH BOOKS

Coilbound, professional quality 50-lb paper sketch book is ideal for use with charcoals, pastels and pencil media. Acid free; 100 sheets.



ORDER NUMBER	DESCRIPTION	UNIT
1 65800-41520	11"×8½"	EA
2 65800-41502	11"×14"	EA

NEW!

D STRATHMORE® 200 SERIES SKETCH PAD

A light weight sketch paper excellent for on-location sketching and practicing techniques. Use with pencil, charcoal, sketching stick and pastel. Fine tooth surface. 50lb. Acid free.



ORDER NUMBER	DESCRIPTION	UNIT
P25-509-1	9"×12"	EA

E HILROY STUDIO® SKETCH PAD

Standard weight white cartridge paper with smooth finish. Coil bound. Perforated header for clean edge when removing sheets; 30 sheets.



ORDER NUMBER	DESCRIPTION	UNIT
65800-41511	9"×12"	EA

F BIENFANG® HARDCOVER SKETCH BOOKS

Bienfang's hardcover sketch book features 75 sheets of superior quality, 70 lb. paper protected by durable polypropylene cover. Paper is acid-free and has a fine tooth surface making it ideal for use with pencil, pen & ink, charcoal or pastel.



ORDER NUMBER	DESCRIPTION	UNIT
234501	9"×12"	EA

G WINNABLE SKETCH BOOK

Durable poly cover with an elastic tie closure. Medium tooth acid free paper.

ORDER NUMBER	DESCRIPTION	UNIT
1 WSB-129-BK	12"×9"	EA
2 WSB-811-BK	8"×11", (landscape)	EA



A BIENFANG® #523 RARITAN DRAWING PAPER PADS

Contains 30 sheets of white heavyweight (70lb) acid-free paper. Medium surface texture stands up against erasing and scraping, and is ideal for techniques utilizing pencil, charcoal, pen & ink.



ORDER NUMBER	DESCRIPTION	UNIT
1 R234221	9"×12"	EA
2 R234230	11"×14"	EA
3 R234257	18"×24"	EA

C HILROY STUDIO PRO™ DRAWING BOOKS

Top bound. 50 lb. acid free paper. White. 50 sheets/book.



ORDER NUMBER	DESCRIPTION	UNIT
1 65800-41516	9"×12"	EA
2 65800-41518	11"×14"	EA

E BIENFANG® MIXED MEDIA PADS

An excellent choice for a wide range of media including watercolours, acrylics, pen and ink, pencils, markers, pastels, collage and more. The fine texture surface accepts wet media well, erases easily, and mixes well. 40 sheets, 90 lb.



ORDER NUMBER	DESCRIPTION	UNIT
1 220100	5½"×8½"	EA
2 220101	9"×12"	EA
3 220102	11"×14"	EA

G BIENFANG® BRISTOL VELLUM DRAWING PAPER PADS

These glue-bound pads contain 20 sheets of 146lb acid-free paper. The fine vellum surface is ideal for use with crayon, coloured pencils, charcoal, and oil pastels.



ORDER NUMBER	DESCRIPTION	UNIT
1 R210121	9"×12"	EA
2 R210130	11"×14"	EA



B CANSON® XL® DRAWING PADS

A smooth surface paper that erases cleanly. Wirebound pad has microperforated true size sheets. 60 sheets. 70lb. 9"×12".



ORDER NUMBER	DESCRIPTION	UNIT
1 100510936	Top bound	EA
2 400054491	Side bound	EA
3 100510915	Top bound, 30% post consumer content	EA

D CANSON® MI-TEINTES PASTEL PAD

Paper contains 50% cotton and is acid free and resistant to fading. Guaranteed longevity. Ideal for: pastel, charcoal, sanguine and pencil. Heavy pronounced texture on one side and a smooth side for detailed work. 24 assorted sheets in a glue bound foldover pad. 98 lb.



ORDER NUMBER	DESCRIPTION	UNIT
100510864	9"×12"	EA

F CANSON® XL® MIX MEDIA PAD

A fine texture paper with heavy sizing for wet and dry media. It erases well and blends easily. Wirebound pad has microperforated true size sheets. 60 sheets. 98lb. 9"×12".



ORDER NUMBER	DESCRIPTION	UNIT
100510927	Side bound	EA

H CANSON® XL® BRISTOL PAD

An exceptionally smooth, bright white surface. 25 sheet smooth. 100lb. 9"×12".



ORDER NUMBER	DESCRIPTION	UNIT
400061834	Fold over	EA

A BIENFANG® GRAPHICS 360 MARKER PADS

50-sheet, tape bound, 100% rag paper pads specially formulated to take heavy marker coverage without bleeding through. Colours flow smoothly yet hold sharp edges. 13½ lb paper accommodates light washes, pen & ink, pencil and other dry media.



ORDER NUMBER	DESCRIPTION	UNIT
1 316121	9"×12"	EA
2 316130	11"×14"	EA

B CRAYOLA® MARKER & WATERCOLOUR PAD

Heavy bright white paper for colouring and painting fun. Pad of 60 sheets.



ORDER NUMBER	DESCRIPTION	UNIT
61-2009	9"×12"	EA

C CANSON® XL® PEN & INK PAD

An ultra smooth, bright white paper that gives the artist clean, crisp lines with no feathering. Perfect for use with felt tip, gel and ballpoint pens, as well as pigment and dye inks. 80 lb. 60 sheets.



ORDER NUMBER	DESCRIPTION	UNIT
400100927	7"×10"	EA

D CANSON® ARTIST GRAPH & LAYOUT PAD

Constructed with a lightweight bond paper and printed with a non-reproducible 4/4 blue grid. 20 lb. / 75g acid free paper. 40 sheets per pad.

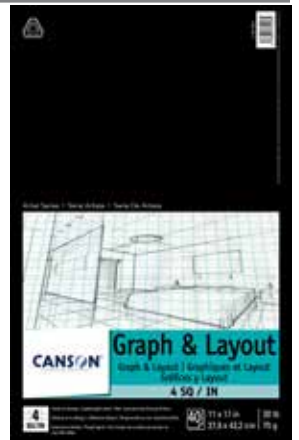

ORDER NUMBER	DESCRIPTION	UNIT
100510874	11"×17"	EA

E CANSON® XL® NEWSPRINT PAD

A rough surface perfect for rapid sketching, drafts and experimenting. Ideal for use with charcoal and pencil. 100 sheets. 30lb. 9"×12".



ORDER NUMBER	DESCRIPTION	UNIT
100510949	Fold over	EA

NEW!

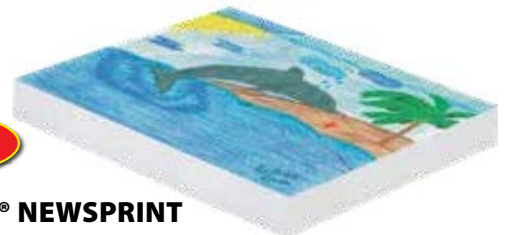

F PACON® NEWSPRINT PAPER

Pacon® Newsprint Paper can be used for drawing, colouring or any classroom project. Sheets are unruled and have a smooth finish. Ideal for use with pens, pencil, charcoal, and crayon. Recyclable.

ORDER NUMBER	DESCRIPTION	UNIT
1 P3401	8½"×11"	500/PK
2 P3414	24"×36"	500/PK

G CANSON® XL® STUDENT DRAWING PAPER

This 70 lb. drawing paper is economical, acid-free paper and has a fine tooth and good erasability. Suitable for pencil, coloured pencil, pen and ink.



ORDER NUMBER	DESCRIPTION	UNIT
100511128	18"×24"	25/PK

NEW!



H PACON® MANILA DRAWING PAPER

Great for beginning drawing and sketching. The medium tooth is perfect for all types of dry media.

ORDER NUMBER	DESCRIPTION	UNIT
P004109	9"×12"	500/PK

NEW!

**A STRATHMORE®
200 SERIES
TRACING PAPER PAD**

This economical white parchment tracing paper has a smooth surface and good transparency. Tape bound pad with 40 sheets. 25lb / 40g.



ORDER NUMBER	DESCRIPTION	UNIT
P25-209-1	9"×12"	EA

**B CANSON® ARTIST
TRACING PAPER PAD**

An exceptionally translucent paper with a smooth surface suitable for pencil, ink and markers that is resistant to scraping. 50 sheets. 25lb.

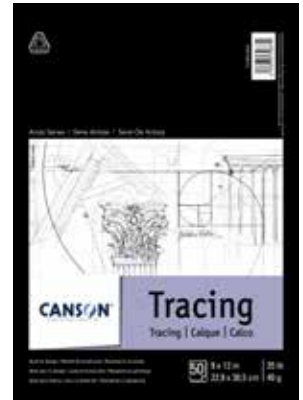

ORDER NUMBER	DESCRIPTION	UNIT
100510960	9"×12"	EA

NEW!

C CANSON® TRACING PAPER ROLL

Exceptionally translucent paper with a smooth surface. Suitable for pencil, ink, and markers. Great for creating artworks large or small without being restricted by a particular paper size. Great for finished artwork, or for practicing and perfecting techniques. 25 lb / 40g.

ORDER NUMBER	DESCRIPTION	UNIT
100510824	18"×60"	EA

**D BIENFANG®
PARCHMENT TRACING
PAPER PAD**

Bienfang® #100 parchment tracing pads are glue-bound, containing medium-weight (24lb), fine surface texture paper that offers premium translucency. Excellent for use with pencil, pen and ink, markers and pastels.

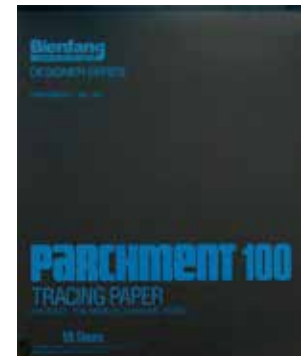

ORDER NUMBER	DESCRIPTION	UNIT
1 240121	9"×12"	EA
2 240130	11"×14"	EA
3 240142	14"×17"	EA



E HILROY STUDIO® TRACING PAPER

Lightweight transparent paper. Smooth, durable surface is perfect for layouts and designs. Erases cleanly; 44 sheets.

ORDER NUMBER	DESCRIPTION	UNIT
65800-41200	9"×12"	EA



**F HILROY
STUDIO® SCRAPBOOKS**

Durable manila paper holds heavy glue and taping. Oversized coil binding.

ORDER NUMBER	DESCRIPTION	UNIT
1 65800-26421	12"×10", 30 sheets	EA
2 65800-26411	14"×11", 20 sheets	EA

**G HILROY
FUNTIME®
SCRAPBOOK**

Features newsprint pages and a sturdy tape binding. Pad contains 36 sheets.

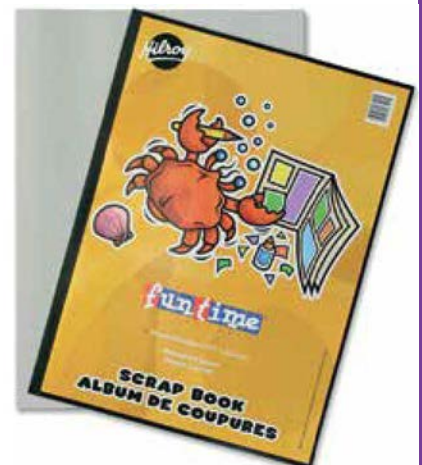

ORDER NUMBER	DESCRIPTION	UNIT
65800-26590	15"×11"	EA

NEW!

A PRANG® CONSTRUCTION PAPER

Perfect for school projects and other arts and crafts. Bright consistent colours with a smooth texture that cuts and folds evenly without cracking.

1 9"×12"

ORDER NUMBER	DESCRIPTION	UNIT	PRICE
P6303	Black	50/PK	\$3.65
P6103	Red		
P8003	Holiday Green		
P8803	Grey		
P7003	Pink		
P8403	Yellow		
P6703	Brown		
P6803	Dark Brown		
P7703	Turquoise		
P9103	Hot Pink		
P9603	Bright Green		
P8703	Bright White		
P7503	Bright Blue		
P9903	Holiday Red		
P6603	Orange		
P7203	Violet		
P7603	Sky Blue		
P6503	Assorted Colours		

2 12"×18"

ORDER NUMBER	DESCRIPTION	UNIT	PRICE
P6307	Black	50/PK	\$6.39
P6107	Red		
P8007	Holiday Green		
P8807	Grey		
P7007	Pink		
P8407	Yellow		
P6707	Brown		
P6807	Dark Brown		
P7707	Turquoise		
P9107	Hot Pink		
P9607	Bright Green		
P8707	Bright White		
P7507	Bright Blue		
P9907	Holiday Red		
P6607	Orange		
P7207	Violet		
P7607	Sky Blue		
P6507	Assorted Colours		

3 18"×24"

ORDER NUMBER	DESCRIPTION	UNIT	PRICE
P6317	Black	50/PK	\$9.99
P8017	Holiday Green		
P8817	Grey		
P8717	Bright White		
P9917	Holiday Red		
P6617	Orange		
P7217	Violet		
P7617	Sky Blue		
P6517	Assorted Colours		

NEW!

B PRANG® SMART-STACK™ CONSTRUCTION PAPER

Heavyweight groundwood grade paper with more sheets of the most frequently used colours. Assorted colours.



ORDER NUMBER	DESCRIPTION	UNIT
P6525	9"×12"	300/PK

C HILROY FUNTIME® CONSTRUCTION PAPER PADS

Assorted colours.



ORDER NUMBER	DESCRIPTION	UNIT
1 65800-41002	9"×12", 96 sheets	EA
2 65800-41016	12"×9", 200 sheets	EA

NEW!

D PRANG® MULTICULTURAL CONSTRUCTION PAPER

Five creative shades for multicultural curriculums. This art and craft paper reflects the rich variety of skin colour found around the world with 5 assorted colours. Practical all-purpose sheets with excellent strength, brightness and durability. Recyclable.

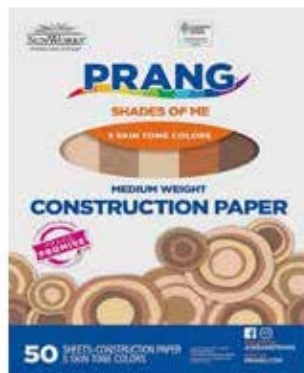

ORDER NUMBER	DESCRIPTION	UNIT
P9509	9"×12"	50/PK

NEW!

E TRU-RAY® HEAVYWEIGHT CONSTRUCTION PAPER

Heavyweight 100% vat-dyed sulphite with longer, stronger fibers. Tru-Ray® Construction Paper is tough enough to take scoring, folding and curling without cracking and tearing. Its superior fade-resistance keeps projects brighter and fresher longer. Acid free for less fade. Recyclable.

ORDER NUMBER	DESCRIPTION	UNIT
1 P102947	9"×12", Warm colours	50/PK
2 P102942	9"×12", Cool colours	50/PK

NEW!

**A PACON®
FADELESS®
PAPER MURAL
ROLLS**

Ultra fade-resistant paper for use on bulletin boards, doors, file cabinets, and more. Also perfect for backgrounds, displays, table skirting, and party decorations. Vibrant colour on one side, plain white on the other. Acid free. Colours: **015** White, **035** Red, **085** Canary, **105** Orange, **175** Blue, **305** Black, **335** Violet.



ORDER NUMBER	DESCRIPTION	UNIT
P0057	48"×50', Specify colour	RL

NEW!

**C COROBUFF®
CORRUGATED PAPER ROLLS**

A true, fade-resistant 3-dimensional paper. Perfect for covering bulletin boards, play scenery, table skirting, and decorating. Exclusive guideline design on the back makes it easy to cut, measure or score. Colours: **011** White, **031** Flame Red, **081** Canary, **101** Orange, **131** Apple Green, **161** Azure, **331** Violet.



ORDER NUMBER	DESCRIPTION	UNIT
P0011	48"×25', Specify colour	RL

NEW!

**E DBLG
TISSUE PAPER**

Versatile art paper is perfect for wrapping gifts or creating crafts like tissue paper flowers. Acid free. Colours: **01** White, **02** Red, **03** Yellow, **04** Orange, **05** Green, **07** Dark Blue, **08** Purple, **09** Light Pink, **10** Dark Pink, **11** Lavender, **12** Turquoise, **13** Brown, **14** Black, **15** Dubonnet, **16** Hunter Green.



ORDER NUMBER	DESCRIPTION	UNIT
1 454	20"×30", Specify colour	24/PK
2 45400	20"×30", Assorted colours	24/PK

NEW!

B RAINBOW® COLOURED KRAFT DUO-FINISH® PAPER

Two-sided with a smooth side that's perfect for felt pens, finger painting and fine line drawing. The other side is a superior, "toothy" surface, perfect for chalk, tempera, water colour and acrylic paints. Comes in a storage box. Colours: **001** White, **021** Brown, **031** Scarlet, **061** Flame, **081** Canary, **101** Orange, **131** Bright Green, **141** Emerald, **151** Sky Blue, **161** Aqua, **171** Bright Blue, **181** Dark Blue, **261** Pink, **301** Black, **331** Purple.



ORDER NUMBER	DESCRIPTION	UNIT
P0066	36"×100', Specify colour	RL

NEW!

**D CREATIVITY
STREET®
CREPE PAPER**

Fade-resistant and bleed-resistant colours to make art projects, classroom decorations, flowers, and much more. This paper is extra fine, lightweight crepe with around 50% stretch. Flame resistant. Colours: **110** White, **120** Buttercup, **130** Bright Orange, **140** Holiday Red, **150** Pink, **160** Royal Purple, **180** Holiday Green, **210** Black.



ORDER NUMBER	DESCRIPTION	UNIT
PAC10	20"×7½', Specify colour	12/PK



F CELLOPHANE ROLLS

Tinted cellophane/ polypropylene rolls with dozens of uses; wrap baskets, gifts or flowers. Works great for different arts & crafts projects at school and at home. Colours: **2** Blue, **3** Red, **4** Green, **6** Clear, **7** Yellow.

ORDER NUMBER	DESCRIPTION	UNIT
4520	20"×12½', Specify colour	RL

A AVERY® MAGNETIC SHEETS

Letter size white, printable magnetic sheet. Use your inkjet printer to create business cards, custom designs and more. Easily cut out with scissors. 8½"×11". Inkjet only.



ORDER NUMBER	DESCRIPTION	UNIT
67933-03270	White	5/EV



C CREATIVITY STREET® KRAFT BAGS

Perfect for many craft projects like making puppets, masks, luminaries, hats and gift bags! Made from high quality uncoated kraft paper that accepts all types of media like crayons, pens, paints and rubber stamps. These #6 flat bottom bags are recyclable. 6"×3⅝"×11".

ORDER NUMBER	DESCRIPTION	UNIT
1 P0072020	White	100/PK
2 P0072140	Assorted colours	28/PK

E DBLG FELT SHEETS

Perfect for cutting into shapes, making costumes, decorations, bulletin board backdrops and school projects. 9"×12". Colours: **61** Black, **62** White, **63** Red, **64** Green, **65** Yellow, **66** Royal Blue, **67** Fuchsia, **68** Pink, **69** Orange, **70** Brown.



ORDER NUMBER	DESCRIPTION	UNIT
1 400	Specify colour	10/PK
2 40090	Assorted colours	10/PK
3 40050	Assorted colours	50/PK

NEW!

G DIXIE UNCOATED PAPER PLATES

Lightweight paper plates. Suitable for arts and crafts.



ORDER NUMBER	DESCRIPTION	UNIT
1 702622WNP6	6"	1000/CT
2 709902WNP9	9"	1000/CT

B AVERY® IRON-ON TRANSFERS

New improved formula! Create custom T-shirts, aprons, gift bags, mouse pads, photographs on quilts and more. Designed for vivid results on cotton or cotton/poly blend fabrics. 8½"×11". For inkjet printers.



ORDER NUMBER	DESCRIPTION	UNIT
1 67933-03275	For white/ light fabrics	12/PK
2 67933-03302	For white/light stretchable fabrics	5/EV
3 67933-03279	For dark fabrics	5/EV

NEW!



D CREATIVITY STREET® WONDERFOAM® SMALL SHEETS

Flexible foam sheets in assorted colours. Easy to cut and accepts many types of glue, glitter glue, paints and markers. 5½"×8½".

ORDER NUMBER	DESCRIPTION	UNIT
PAC4301	Assorted colours	40/PK



F DBLG® CRAFT FOAM SHEETS

Assorted colours.

ORDER NUMBER	DESCRIPTION	UNIT
1 37710	12"×18"	10/PK
2 37520	9"×12"	10/PK

H PAPERUS PAPER PLATES

ORDER NUMBER	DESCRIPTION	UNIT
1 21016	6"	1000/CT
2 21018	8"	500/CT
3 21019	9"	500/CT





A SELECTUM WIGGLE EYES

Bring your craft creations to life. These wiggle eyes have a flat back for gluing. Assorted colours.

ORDER NUMBER	UNIT
54461	100/PK

NEW!



C CREATIVITY STREET® WIGGLE EYES

Wiggle Eyes bring projects to life! Sizes include 25 each of 7 mm, 10 mm, 12 mm, and 15 mm. Ideal for the classroom, art room, daycare, or home.

ORDER NUMBER	DESCRIPTION	UNIT
1 PAC3446-02	Glue on, Black	100/PK
2 PAC3446-10	Peel and Stick, Assorted colours	100/PK



B DBLG WIGGLE EYES

Googly eyes make many craft projects come alive with their silly and cute appearance. Perfect for decorating sock puppets, farm animals, clowns and more.

ORDER NUMBER	DESCRIPTION	UNIT
1 37210	10mm, Black	100/PK
2 37215	15mm, Black	100/PK
3 37264	Assorted sizes, Black	100/PK
4 38203DBLG	Assorted sizes and colours	300/PK



D DBLG CRAFT STICKS

Perfect for crafts and other projects.

ORDER NUMBER	DESCRIPTION	UNIT
1 35505	4½" Natural	150/PK
2 35507	6" Natural	100/PK
3 35506	4½" Assorted colours	200/PK



E SELECTUM® POM-POMS

Add more excitement to your art projects with these Pom-Poms in assorted sizes and colours.

ORDER NUMBER	UNIT
54470	100/PK

NEW!

G CREATIVITY STREET® POM POMS

Add texture, dimension and colour to any project! 141.7gm (5 ounce) classroom pack assortment of approximately 300 pom poms including a variety of colours and sizes from ½" to 1½".

ORDER NUMBER	UNIT
PAC8150-01	300/PK



NEW!

F CREATIVITY STREET® CRAFT STICKS

Creative Street "Ice cream stick" wood craft sticks are designed for a multitude of arts and crafts projects. Each stick is 2 mm thick.



ORDER NUMBER	DESCRIPTION	UNIT
1 PAC3775-01	4 ½"×⅜" Natural	1000/BX
2 PAC3775-02	4 ½"×⅜" Coloured	1000/BX
3 PAC3776-01	6"×¾" Natural	500/BX
4 PAC3776-02	6"×¾" Coloured	500/BX



H DBLG WOOD DOWELS

Perfect for any arts and crafts projects. Let creativity flow as children use this in various projects.

ORDER NUMBER	DESCRIPTION	UNIT
35516	12mm×5mm	16/PK



A DBLG WOOD ALPHABET BEADS

These alphabet beads are perfect for beading projects, ABC learning or kids craft activities. Use wooden beads to design jewelry with your preschooler.

ORDER NUMBER	UNIT
35354	250/PK



B DBLG CRAFT BEADS

Assorted colours.

ORDER NUMBER	DESCRIPTION	UNIT
1 35557	Hearts	500/PK
2 35559	Stars	500/PK



C DBLG PONY BEADS

Create fun necklaces or bracelets with these smooth beads. Assorted colours. 6mm×9mm.

ORDER NUMBER	UNIT
35800	1000/PK



D DBLG BEADING THREAD

Clear stretch cord. 100m.

ORDER NUMBER	UNIT
21121	EA



E SELECTUM® CHENILLE PIPE CLEANERS

Easy to add colour, texture, and dimension to any art or craft project. Stems can bend, twist, curl or wrap to just about any shape. Colours: **12** 50T Assorted, **13** Black, **15** Red, **16** Blue, **17** Green, **18** Brown, **19** Orange, **20** Yellow, **21** Dark Blue, **22** Pink, **23** Violet, **24** White.

ORDER NUMBER	DESCRIPTION	UNIT
1 533	12", Specify colour	100/PK
2 53314	6" Assorted colours	100/PK



F DBLG DAZZLE BEADS

Faceted plastic beads in assorted transparent colours. 8mm.

ORDER NUMBER	UNIT
35404	1000/PK



G CREATIVITY STREET® FEATHERS

Perfect addition to any arts and crafts project! Glue or tape to masks, collages and other mixed media projects. Bright Hues assortment.

ORDER NUMBER	DESCRIPTION	UNIT
1 PAC4502	Plumage feathers, 28 g	PK
2 PAC4504	Marabou feathers, 14 g	PK



H SELECTUM® DECORATIVE FEATHERS

Add dimension to projects and bring crafts to life. Great for costumes, art projects and more.

ORDER NUMBER	DESCRIPTION	UNIT
1 54451	Medium Size	20/PK
2 54450	Small Size	10/PK



I DBLG FELT LETTERS

Use these letters at home, for birthday party decor, for making craft projects, greeting cards, gift tags and DIY projects. Assorted colours.

ORDER NUMBER	UNIT
40130	104/PK

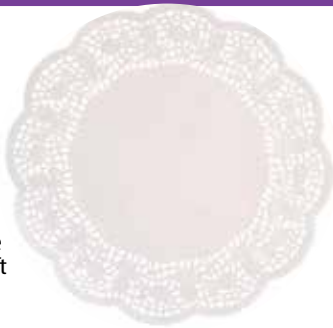

A DBLG PAPER DOILIES

Round paper lace doilies for festive table settings, bulletin boards, craft projects, card making and more.

ORDER NUMBER	DESCRIPTION	UNIT
1 45051	4"	100/PK
2 45053	6½"	100/PK
3 45054	8"	100/PK



C SELECTUM® DECORATIVE GLITTER

Great for all kinds of arts and crafts projects.
12g Colours: **90** Red, **91** Blue, **92** Green, **93** Gold, **94** Assorted, **95** Silver.
454g Colours: **87** Red, **88** Blue, **89** Green, **91** Gold, **92** Assorted, **94** Silver.

ORDER NUMBER	DESCRIPTION	UNIT
1 545	12g / .4oz., Specify colour	EA
2 549	454g / 1lb., Specify colour	EA



G FUNNY® MAT TABLE TOP COLOURING MAT

For use with water-based, non-permanent markers. Washable and re-usable. Made of polypropylene. 48×33.5 cm (18.9"×13.2").

ORDER NUMBER	DESCRIPTION	UNIT
1 67897-02036	The Prince & The Princess	EA
2 67897-02032	Space	EA
3 67897-02033	Jurassic Period	EA
4 67897-02038	Numbers	EA
5 67897-00587	Bugs	EA
6 67897-00581	Wild Animals	EA
7 67897-00582	Deep Sea	EA



B DBLG STYROFOAM™ BALLS

ORDER NUMBER	DESCRIPTION	UNIT
1 36300	Assorted (25, 50, 75, 100 mm)	16/PK
2 36301	25 mm	24/PK
3 36302	50 mm	24/PK
4 36303	75 mm	12/PK

D DBLG DOOR HANGERS

Precut foam door hangers. Create designs paint signs or glue messages onto these blank door hangers. Assorted colours.



ORDER NUMBER	UNIT
38560	12/PK



E FUNNY® MAT COLOURING ACTIVITY SET

Reusable set in the shape of spiral notebook. Pre-printed designs and a blank sheet can be coloured with washable markers. Colours wash off under running water or can be wiped clean with a wet cloth. Includes water-based markers and built-in handle to carry on the go. 10¼×7½".



ORDER NUMBER	DESCRIPTION	UNIT
1 67897-02056	Which Way to Go?	ST
2 67897-02057	Lots of Things To Do	ST

F SNAZAROO™ FACE PAINTING STICKS

Just draw on your skin! Fun for school carnivals, costume parties and more, paint is easy to remove with soap and water.

ORDER NUMBER	DESCRIPTION	UNIT
1172074	Six colours	6/PK



Paints up to 50 FACES!

Paints up to 65 FACES!

H SNAZAROO™ FACE PAINTING KITS

Draw on your skin! Fun for school, carnivals, costume parties and more! Easily remove with soap & water.

ORDER NUMBER	DESCRIPTION	UNIT
1 1172069	Unisex	PK
2 1172071	Ultimate Party Pack	PK



NEW!

A UHU TWIST & GLUE SCHOOL GLUE

Unique twist applicator for gluing dots, lines and larger surfaces. Dries clear. Bonds to paper, wood, fabric and more. Perfect for home, school and office. Washable and non-toxic. 95 mL.



ORDER NUMBER	UNIT
9U34040	EA

C CRAYOLA® WASHABLE PROJECT GLUE

Won't run, dries clear, and resists cracking.



ORDER NUMBER	DESCRIPTION	UNIT
66-1108	236 mL	EA

NEW!

E ELMER'S® GUE SLIME

It's a premade slime that comes ready to play with right out of its slime container. Stretch it, squish it, twist it; explore all the fun ways to play. 118.25 mL.



ORDER NUMBER	DESCRIPTION	UNIT
1 2149168	Fruity Slushie	EA
2 2149167	Glassy Clear	EA
3 2149166	Cosmic Shimmer	EA

NEW!

G DBLG PASTE BRUSH AND SPREADER

The brush has a plain handle and hog hair bristles. Size 2. 3/8". The spreader is made of flexible plastic.



ORDER NUMBER	DESCRIPTION	UNIT
1 29626	Brush	10/BX
2 49424	Spreader	10/PK



Our Brand, YOUR Savings!

B OP BRAND GLUE STICKS

Positive seal cap prevents dry-out; harder formulation spreads evenly. For paper, cardboard, fabric, photos, etc.



ORDER NUMBER	DESCRIPTION	UNIT
1 27811-10004	20 g	EA
2 27811-10005	40 g	EA

NEW!

D ELMER'S® ALL PURPOSE WASHABLE GLUE STICKS

All-purpose and photo safe. Non-toxic, acid-free. Permanent.



ORDER NUMBER	DESCRIPTION	UNIT
61550-60556	8 g	30/BX

F ELMER'S® RE-STICK GLUE STICKS

Adjustable for up to 5 minutes. Washable, safe and non-toxic. 8 g.



ORDER NUMBER	DESCRIPTION	UNIT
E4806	8 g	6/PK

NEW!

H ELMER'S® SCENTED GLUE STICKS

Inspire your child's imagination! Your little learner will be delighted as they work on their next school project. A fun way to attach items to paper, display board, foam board, photos, and much more. Washable, safe, and non-toxic formula. 6 g. Apple Pie, Sugar Cookie, Blueberry Muffin and Watermelon scents.



ORDER NUMBER	UNIT
2142958	4/PK

I ELMER'S® WASHABLE SCHOOL GLUE

All-purpose glue for paper and other materials. Non-toxic; dries clear.

ORDER NUMBER	DESCRIPTION	UNIT
1 60308Q	White, 120 ml	EA
2 60310Q	White, 225 ml	EA
3 61550-60341	White, 3.8 L	EA
4 60305Q	Clear, 147 ml	EA
5 2048351	Clear, 3.78L	EA



A PRANG® MODELLING CLAY

An outstanding colour range makes this the perfect clay for modelers and hobbyists. Warms up quickly to make shaping fast and fun; has a rich, smooth texture. Non-staining on clothes and skin. 1 lb box. Colours: **81** Red, **82** Orange, **83** Yellow, **84** Green, **85** Blue, **86** Violet, **87** White, **88** Brown, **89** Black, **90** Grey.

ORDER NUMBER	DESCRIPTION	UNIT
1 72067-007	1 lb. block, Specify colour	PK
2 72067-00740	4× ¼ lb. sticks, Red, Blue, Green and Yellow, individually wrapped	PK



C STAEDTLER® FIMO® MODELLING CLAY

Ideal for a rainy day, art, leisure, hobby as well as for educational purposes! Great at home and in the classroom. Hardens in the oven. 25 g.

ORDER NUMBER	DESCRIPTION	UNIT
1 8023 C12-1	Assorted Basic colours	12/PK
2 8023 C12-3	Assorted Pastel colours	12/PK



E DAS® MY CREATIVE TOOLSET™

Durable carving tools work on any clay. Metal wire edges help shave, while plastic spatulas help carve. Includes two wire and two plastic sculpting tools and a bonus rolling pin. 4+1 bonus.

ORDER NUMBER	UNIT
72067-00321	EA



G DBL CLAY TOOLS

Used to shape and mold clay, dough or wax.

ORDER NUMBER	UNIT
49423	8/ST

B CRAYOLA® MODELLING CLAY

Clay will not dry out or harden. Red, blue, green and yellow. 1 lb.

ORDER NUMBER	UNIT
57-0304	4/BX



D CRAYOLA® MODEL MAGIC

A fun modelling material that air dries in 24 hours. Projects can be decorated with paint, markers and decorative glues.

ORDER NUMBER	DESCRIPTION	UNIT
1 57-4400	White, 4× 8 oz.	4/PK
2 03-6001	White, 75× 1 oz.	75/BX
3 57-4415	Assorted colours, 4× 8 oz.	4/PK
4 03-6002	Assorted colours, 75× 1 oz.	75/BX

F DAS® JUNIOR AIR-HARDENING MODELLING CLAY

Soft & ready to use. Colours remain bright even when dry, and can be mixed together to create infinite shades. Mineral based and gluten free. 100 g blocks. Assorted colours.

ORDER NUMBER	UNIT
F349200	10/BX



NEW!

H STAEDTLER® FIMOAIR® MODELLING CLAY

Air dries and is easy to use. 95% natural raw materials. Hardened objects can be sanded, painted and drilled. White.

ORDER NUMBER	DESCRIPTION	UNIT
1 8100-009	500 g	EA
2 8101-0A6	1 kg	EA



Arts & Crafts – coloured pencils



A CRAYOLA® COLOURED PENCILS

Pre-sharpened; provide smooth, even coverage in bright, vibrant colours.

ORDER NUMBER	DESCRIPTION	UNIT
1 67-2012	12 colours	12/PK
2 67-2024	24 colours	24/PK
3 67-2060	60 colours	60/PK



B CRAYOLA® COLOURED PENCILS CLASSPACK

Made from reforested wood. Non-toxic, AP certified. Pre-sharpened, with thick lead. Includes 20 pencils in each of 12 colours plus 20 hand held sharpeners.

ORDER NUMBER	DESCRIPTION	UNIT
68-8024	240 pencils	BX



C STAEDTLER® TRIANGULAR COLOURED PENCILS

Ergonomic triangular barrel with 4mm lead. Pre-sharpened with soft easy to blend, brilliant colours. Rich pigments lay down smoothly.

ORDER NUMBER	DESCRIPTION	UNIT
1 1278CC12A6	12 colours	12/ST
2 1278CC24A6	24 colours	24/ST
3 1278CC48A6	48 colours	48/ST



D PRANG® COLOURED PENCIL CRAYONS

3.3mm core pencils come pre-sharpened AP certified non-toxic.

ORDER NUMBER	DESCRIPTION	UNIT
1 72067-22120	12 colours	12/ST
2 72067-22240	24 colours	24/ST



E CRAYOLA® COLORS OF THE WORLD COLOURED PENCILS

Make colouring pages and drawings even more detailed and realistic with skin tone pencils. Three main shades: Almond, Golden and Rose, and darker/lighter shades in between to better represent diversity. Presharpened. FSC Certified®. Assorted colours.

ORDER NUMBER	DESCRIPTION	UNIT
1 67-4154	24 colours	24/PK
2 68-2023	Classpack NEW!	240/BX



F DERWENT ACADEMY™ COLOURED PENCILS

Made with natural wood barrels and quality pigments. Includes tin storage case. Assorted colours.

ORDER NUMBER	DESCRIPTION	UNIT
2301938	24 colours	PK



G PRISMACOLOR® SCHOLAR® COLOURED PENCILS

Student quality.

ORDER NUMBER	DESCRIPTION	UNIT
1 92804	12 colours	ST
2 92805	24 colours	ST
3 92808HT	60 colours	ST



H PRISMACOLOR® PREMIER® COLOURED PENCIL TINS

High quality professional artist tools that inspire your inner artist.

ORDER NUMBER	DESCRIPTION	UNIT
1 2023752	Botanic Garden theme colours	12/ST
2 2023751	Under the Sea theme colours	12/ST



I STAEDTLER® COLOURED PENCILS

Soft blendable colours. Includes metal storage tin. Assorted colours.

ORDER NUMBER	DESCRIPTION	UNIT
1 175M36A6	36 colours	36/ST
2 175M72A6	72 colours	72/ST

NEW!

A PRANG® TRIANGULAR COLOURED PENCILS

Triangular shape provides writing comfort.



ORDER NUMBER	UNIT
72067-25120	12/PK

B PRANG® DUO-COLOR™ DOUBLE SIDED COLOURED PENCILS

Twice the colours in half the volume. Presharpened. Assorted colours.



ORDER NUMBER	UNIT
1 72067-22106	6/PK
2 72067-22112	12/PK
3 72067-22118	18/PK



C MERANGUE PENCIL CASE

Oblong shaped. 420 denier nylon. Features 2 zippers. Black. 9"L×3¼"H×2½"D

ORDER NUMBER	UNIT
1015-4390-20-000	EA



D MERANGUE® 3 RING BINDER POUCH

Strong nylon construction. 3 metal rings. Easily fits binders. Assorted colours.

ORDER NUMBER	DESCRIPTION	UNIT
1015-4360-00-000	9.7"L×7.3"H×0.03"D	EA



E IT'S ACADEMIC FLEXI STORAGE BOXES

Adjustable storage case expands to 3"H to hold belongings securely inside. Made of durable and ductile rubber material to stretch and expand. Latches shut with contrasting closure. 6"×9".

ORDER NUMBER	DESCRIPTION	UNIT
1 23133	Blue & Black	EA
2 23134	Pink & Grey NEW!	EA
3 23135	Purple NEW!	EA



F STOREX® PLASTIC PENCIL BOX

Clear bottom allows for quick & easy identification of contents. Lid snaps shut with an integrated latch. Durable plastic construction. 8.38"L×5.63"W×2.5"H.

ORDER NUMBER	DESCRIPTION	UNIT
1 61623U12C	Blue	EA
2 61605U12C	Assorted colours	EA



G WINNABLE BACKPACK POUCH

Frosted poly bag, coloured zippered edge. 10½"×12¼". Assorted colours.

ORDER NUMBER	UNIT
20130	EA



H VLB PENCIL CASE WITH ORGANIZER

Frosted hard case with snap closure. Features two extra compartments on top. 8½"W×2½"D×5½"H. Assorted colours.

ORDER NUMBER	UNIT
AE92960	EA



I STAEDTLER® PENCIL SHARPENERS

Student quality; in sets or three individual colours.

ORDER NUMBER	DESCRIPTION	UNIT
1 511 63	Single hole	EA
2 512 001 A6	Double hole	EA
3 511 300M NA	Mini oval NEW!	EA

Arts & Crafts – crayons



A CRAYOLA® CRAYONS

Regular size crayons in 8, 16, 24, 64 or 96 different colours. Boxes of 64 and 96 have a built-in sharpener on the box.

ORDER NUMBER	DESCRIPTION	UNIT
1 52-0008	8 colours	PK
2 52-0016	16 colours	PK
3 52-0024	24 colours	BX
4 52-0064	64 colours	BX
5 52-0096	96 colours	BX

C CRAYOLA® LARGE CRAYONS

Large wax crayons with brighter, vibrant colours. Easy for little hands to hold, so they can enjoy drawing at a younger age.

ORDER NUMBER	UNIT
52-0080	8/PK



D YOUNG ARTISTS CRAYOLA™ TRIANGULAR CRAYONS

Triangular barrel shape guides toddlers' fingers into the correct writing grip.

ORDER NUMBER	UNIT
80-6868	8/PK



F CRAYOLA® LARGE SIZE WASHABLE CRAYONS

The perfect colouring book crayons for little hands. Easy-to-grip and washable – designed to wipe off most walls and nonporous household surfaces with just warm water and a sponge.

ORDER NUMBER	UNIT
52-3280	8/PK



G DEFLECTO® 6 CUP CADDY

Lightweight & portable. Six separate cups allow neat organisation. Great for storing and carrying all types of classroom supplies. Comes with SteriTouch® Antimicrobial protection for the life of the product. Plastic. 9½"W×12¼"D×5¼"H.

ORDER NUMBER	DESCRIPTION	UNIT
1 39509BLU	Blue	EA
2 39509RED	Red	EA
3 39509YEL	Yellow	EA



B CRAYOLA® CRAYON CLASSPACKS

Regular size – 8 colours, 100 of each. Large size – 8 colours, 50 each.

ORDER NUMBER	DESCRIPTION	UNIT
1 52-8800	800 regular	BX
2 52-8038	400 large	BX

E CRAYOLA® COLORS OF THE WORLD CRAYONS

Make colouring pages and drawings even more detailed and realistic with skin tone crayons. Subtle shades fall in three main shades: Almond, Golden and Rose – and darker or lighter shades in between to better represent growing diversity.

ORDER NUMBER	DESCRIPTION	UNIT
1 52-1733	24 Colours	24/PK
2 52-3456	NEW! Classpack	480/BX

CRAYOLA® COLORS OF THE WORLD COLOURING BOOK

Young artists can colour their way across the globe visiting iconic landmarks and making new friends in more than 20 countries. Makes great gift for kids and perfect addition to classroom supplies. 48 pages.

3 61-0586	Colouring book	EA
-----------	----------------	----





A CRAYOLA® WASHABLE MARKERS

Designed to wash from hands and clothing.

ORDER NUMBER	DESCRIPTION	UNIT
1 58-7208	Wedge tip, 8 classic colours	PK
2 56-7910	Conical tip, 10 colourset	PK
3 56-7916	Conical tip, 16 colourset	PK
4 58-7510	Fine tip, 12 classic colours	PK
5 56-8612	Fine tip, 12 bold colourset	PK
6 56-8524	Fine tip, 24 colourset	PK



B CRAYOLA® WASHABLE MARKERS CLASSPACK

Broad, conical tip, washable markers.

ORDER NUMBER	DESCRIPTION	UNIT
1 58-8200	8 Colours	200/BX
2 58-8201	16 Colours	256/BX



C YOUNG ARTISTS CRAYOLA® TRIANGULAR MARKERS

Great for all kinds of arts and crafts projects. The triangular barrel is designed to fit nicely in toddler hands and promotes the proper writing grip. Assorted colours.

ORDER NUMBER	UNIT
80-6813	8/PK



D MR. SKETCH® SCENTED WASHABLE MARKERS

Washable bright colours, "juicy scented" markers. Exciting and fun markers for kids. Assorted colours. Chisel tip

ORDER NUMBER	UNIT
1 1925829	10/PK
2 2003992	36/BX



E CRAYOLA® COLORS OF THE WORLD WASHABLE MARKERS

Make colouring pages and drawings even more detailed and realistic with skin tone markers. Subtle shades fall in three main shades: Almond, Golden and Rose – and all the darker or lighter shades in between to better represent growing diversity. Broad tip. Washable.

ORDER NUMBER	DESCRIPTION	UNIT
1 56-7709	24 Colours	24/PK
2 58-8228	Classpack NEW!	240/BX



F CRAYOLA® FINE CLASSIC MARKERS

Non-toxic, non-washable. Fine tip. Classic Colours.

ORDER NUMBER	UNIT
58-7613	12/PK



G MR. SKETCH® SCENTED MARKER SET

Ideal as an easel pad marker. Watercolours are bright and vivid. Smooth-flowing bevel tip makes sketching easier. Tip keeps its shape after months of colouring. Markers are certified AP non-toxic. Chisel tip.

ORDER NUMBER	UNIT
1904150	12/ST

H PILOT® FRIXION ERASABLE COLOURING MARKERS

Erasable markers for marking or colouring. Easy to use, safe for children – no residue, no odour. Polyester fibre tips.

ORDER NUMBER	DESCRIPTION	UNIT
1 SW-FC-S6	Fine, 6 colours	6/ST
2 SW-FC-S12	Fine, 12 colours	12/ST
3 SW-FC-BK	Medium, Black	EA





A STAEDTLER® DUO-COLOR MARKERS

Double ended fibre tip markers wash easily out of most textiles. Line widths are 0.5mm - 0.8mm and 3.0mm with Assorted colours. Box made with 90% post consumer recycled PET, barrels made with 100% recycled material.



ORDER NUMBER	UNIT
1 3200 TB36	36/PK
2 3200 TB72	72/PK

B CRAYOLA® WINDOW WRITERS

Washable conical tip markers specially formulated to decorate windows, glass, mirrors, foil and more. Easy clean-up. Non-toxic.



ORDER NUMBER	UNIT
56-9704	10/ST

C STAEDTLER® ART PIGMENT LINERS

Versatile fibre tip pens for sketching and drawing. Black ink. Available in line widths: **01** 0.1 mm, **03** 0.3 mm, **05** 0.5 mm and **07** 0.7 mm.



ORDER NUMBER	DESCRIPTION	UNIT
1 308 __-9	Specify line width	EA
2 308 A6 WP4	Set of 4	ST

D SHARPIE® ART PENS

Discover bold colour that won't bleed through paper and is acid free, quick drying and formulated to resist both smearing and fading. Fine tip. Featuring a sturdy stand-up hard case that opens into an easel. Assorted colours.



ORDER NUMBER	UNIT
1802226	12/PK

NEW!

E BIC® INTENSITY COLOR CHANGE! FINELINERS

Great for everyday writing, doodles and illustration. Write in one colour, then erase over the writing to reveal a contrasting second colour. Bullet tip. Assorted Colours.



ORDER NUMBER	UNIT
70330-37440	6/PK

F BIC® INTENSITY PERMANENT MARKERS

Waterproof, non-toxic and fast-drying. Won't dry out even the cap is left off for 2 weeks. Comfortable rubber grip. Fine tip. Assorted colours.



ORDER NUMBER	UNIT
70330-32592	12/PK

G ZEBRA CLICKART RETRACTABLE MARKERS

Great for everyday writing, doodles and illustration. Never dries out. Bullet tip. Assorted colours.



ORDER NUMBER	UNIT
1 45888-69006	6/PK
2 45888-69012	12/PK

H STAEDTLER® DOUBLE-ENDED BRUSH LETTERING PENS

One pen, two tips. Flexible brush on one end and fine tip marker on the other. 1.0 - 6.0 mm brush tip and 0.5 - .08 mm pen tip. Assorted colours.



ORDER NUMBER	UNIT
3004 TB12	12/ST



A TOMBOW DUAL BRUSH PENS

Versatile, flexible, nylon fibre brush tip creates medium or bold strokes by changing brush pressure. The water based ink is blendable, odorless and non-bleeding. Acid free and non-toxic. Ideal for fine art, illustrations, doodling, journaling, hand lettering and more. Tips self-clean after blending.

ORDER NUMBER	DESCRIPTION	UNIT
1 56167	Primary colours	10/PK
2 56168	Secondary colours	10/PK
3 56171	Greyscale colours	10/PK
4 56185	Bright colours	10/PK
5 56170	Portrait colours	10/PK
6 56169	Landscape colours	10/PK
7 56187	Pastel colours	10/PK
8 56188	Galaxy colours	10/PK



C ZEBRA ZENSATIONS METALLIC BRUSH PENS

Add brilliant metallic colour to lettering and drawing projects. Soft tip allows for thick or thin line. Archival quality, water resistant Acid-free ink. AP Certified Non-toxic. Assorted colours.



ORDER NUMBER	UNIT
45888-01607	7/PK



E STAEDTLER® DOUBLE-ENDED WATERCOLOUR BRUSH PENS

Ideal for detailed sketching and illustration for beautiful watercolour effects on most watercolour papers. One pen, two tips: flexible brush and a thin tip. Assorted colours.

ORDER NUMBER	UNIT
1 3001 TB18	18/PK
2 3001 TB36	36/PK



B STAEDTLER® METALLIC MARKERS

Brush tip works like a paintbrush to create fine, medium or bold strokes. Blendable, odourless water-based ink. Assorted colours.

ORDER NUMBER	DESCRIPTION	UNIT
1 8321TB5A6	Brush Lettering	5/PK
2 8325TB5A6	Calligraphy	5/PK
3 8323TB5A6	Adventure Awaits Pens	5/PK



D ZEBRA ZENSATIONS BRUSH PENS

Perfect tool for art or calligraphy projects. The deep rich black colour and flexible tips create varying line widths depending on applied pressure. Archival quality, water resistant Acid-free ink. 2 Ultra Fine tip, 2 Fine tip, 1 Medium tip, and 1 Double ended pen. Black.



ORDER NUMBER	UNIT
45888-01006	6/PK



F PRIMO BINGO DAUBERS

100 mL. For use in fun bingo games or adding colour to art and crafts.



ORDER NUMBER	DESCRIPTION	UNIT
1 SL91260	Blue	EA
2 SL91261	Green	EA
3 SL91262	Pink	EA
4 SL91263	Purple	EA
5 SL91264	Red	EA

A STAEDTLER® SOFT CHALK PASTELS

Perfect for both the amateur and experienced artist. Brilliant colours are rich in pigments and feature a soft smooth texture. Easy to blend. Smudge easily and can go over each other. Water soluble and can be brushed with water. Certified non-toxic.



ORDER NUMBER	DESCRIPTION	UNIT
2430 C12	12 colours	12/ST

B STAEDTLER® OIL PASTELS

Ideal for the student or aspiring artist. Brilliant colour. Adhere easily to all smooth surfaces for creamy, smooth performance. Medium soft with smooth opacity. Extremely vibrant colours are easy to blend. Waterproof and highly break resistant. Certified non-toxic.



ORDER NUMBER	DESCRIPTION	UNIT
1 2420 C12	12 colours	12/ST
2 2420 C24	24 colours	24/ST

C DERWENT® ACADEMY™ SOFT PASTELS

Soft, easy to blend texture with beautiful pigmentation. Versatile square shape lets you do fine detailed work or apply lots of colour to a page quickly. Assorted colours.



ORDER NUMBER	UNIT
98216	24/PK

D PENTEL ARTS® OIL PASTELS

ORDER NUMBER	DESCRIPTION	UNIT
1 PHN-12	12 sticks	ST
2 PHN-16	16 sticks	ST
3 PHN-25	25 sticks	ST
4 PHN-36	36 sticks	ST
5 PHN-50	50 sticks	ST



E PRANG® GALLERY™ PASTELLO® CHALK PASTELS

The chalk that bridges the gap between soft and hard pastels. It has the sharp edge of a hard pastel and the soft texture used for sketching and details.



ORDER NUMBER	DESCRIPTION	UNIT
72067-10441	Assorted colours	12/PK

F PRANG® GALLERY™ SKETCHO® OIL PASTEL CRAYONS

Obtain many different effects by blending, drawing, staining and dipping. Assorted colours.

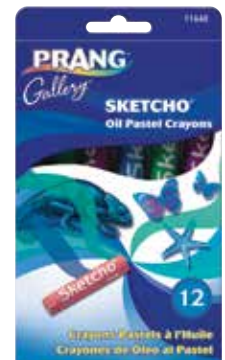

ORDER NUMBER	UNIT
72067-11660	12/PK

G PRANG® GALLERY™ AMBRITE® PAPER CHALK

Soft, grit free, moulded chalk with intensely bright, rich colours. For paper, cardboard or similar surfaces.



ORDER NUMBER	DESCRIPTION	UNIT
72067-53012	Assorted colours	12/PK

H CRAYOLA® OIL PASTELS

Rich colours and creamy laydown. Colours are easy to blend. Hexagonal shape. Pointed tip.



ORDER NUMBER	DESCRIPTION	UNIT
1 52-4629	Classpack, 12 colours	336/BX
2 52-4616	Assorted colours	16/PK



A CONTÉ À PARIS™ CRAYONS

12 crayons in a plastic case.

ORDER NUMBER	DESCRIPTION	UNIT
1 50237	Black HB sketching	12/ST
2 50233	White HB sketching	12/ST
3 50128	Pastel colours	12/ST



B DERWENT® TINTED CHARCOAL PENCILS

Combining natural charcoal particles with the finest clays, the pencils are wood-cased for easy control and can be sharpened to a fine point. They can be smudged and blended together to produce satisfyingly deep, rich tones. There are 12 subtle colours to choose from, including white for burnishing and highlights.

ORDER NUMBER	UNIT
2301690	ST

C PRANG® GALLERY™ CHARCOAL PENCILS

Paper wrapped with pull string for self-sharpening. Medium and Soft.

ORDER NUMBER	UNIT
72067-60300	2/PK



D DERWENT® CHARCOAL PENCILS

Metal tin contains 1 light, 2 medium, 2 dark, 1 tinted charcoal white, and a pencil sharpener. Tone is similar to graphite. A combination of natural charcoal particles with the finest clays. Smooth lay down and blends easily.

ORDER NUMBER	UNIT
0700838	ST



E DERWENT® ACADEMY™ PAPER STUMPS

Paper Stumps are perfect for blending and smudging media such as charcoal and pastels. Defined tips provide accuracy in small areas. 3 assorted sizes.



ORDER NUMBER	UNIT
98248	3/PK

F DERWENT® BURNISHER AND BLENDER SET

Includes 2 blender pencils, 2 burnisher pencils, a plastic sharpener and a plastic eraser. The Blender is a soft colourless pencil that allows you to blend two or more colours together. The burnisher is a hard colourless pencil which when used over layers of pigment provides a rich polished finished.



ORDER NUMBER	UNIT
2301774	ST

G WINSOR & NEWTON® ARTISTS' FIXATIVE

A colourless medium which provides protection for charcoal, pencil, pastel & chalk drawings. Aerosol for easy application.



ORDER NUMBER	UNIT
3046913	EA



A HILROY STUDIO PRO™ ARTIST'S KIT

Basic sketching and design supplies for new artists. Includes eight sketching pencils (8B, 6B, 4B, 2B, HB, F, H, 2H), two charcoal sticks, one woodless sketching pencil, three charcoal pencils, two erasers and two sharpeners.

ORDER NUMBER	UNIT
65800-41058	ST



B STAEDTLER® MARS LUMOGRAPH DRAWING PENCILS

Available individually or in two different sets of 12 popular grades in a tin box. Grades: **6H, 5H, 4H, 3H, 2H, H, F, HB, B, 2B, 3B, 4B, 5B, 6B, 7B, 8B.**

ORDER NUMBER	DESCRIPTION	UNIT
1 100 G6	8B-HB	6/ST
2 100 G12	6B-4H	12/ST
3 100 G12S	8B-2H	12/ST
4 100-__	Specify grade	EA



C HILROY STUDIO PRO™ SKETCH AND DESIGN PENCILS

Pre-sharpened pencils with break-resistant leads write smoothly on any paper surface.

ORDER NUMBER	DESCRIPTION	UNIT
65800-41092	14 pencils, (8B-4H)	14/ST



D TOMBOW MONO DRAWING PENCIL SET

Perfectly centered lead core adhered throughout entire woodcase, making pencil break resistant and ensures even sharpening. Progressive range from 6B - 4H. Easily erase graphite pencil marks with included light touch plastic eraser. Set includes 12 pencils, plastic eraser and pencil sharpener.

ORDER NUMBER	UNIT
51523	ST



E DALER-ROWNEY SIMPLY™ 13-PIECE SKETCHING SET

This set includes: 4 sketching pencils: HB, 2B, 4B, 6B, 2 pastel sticks, 2 charcoal sticks, 2 paper blending sticks, 1 eraser, 1 pencil sharpener, and 1 block of sandpaper sheets. The pastels and charcoal sticks can be mixed and blended using the paper sticks to create a variety of effects and styles.

ORDER NUMBER	UNIT
64420000	ST



F DERWENT® SKETCHING COLLECTION

Including Drawing, Pastels and watersoluble Sketching Pencils, plus traditional products like Natural Graphite and Compressed Charcoal Blocks.

ORDER NUMBER	UNIT
34306	24/ST



A STAEDTLER® WATERCOLOUR PENCILS

Allow the artist unlimited freedom to switch from drawing to painting in an instant. Brilliant colours are soft and easy to blend. Rich pigments lay down smoothly. Triangular shape is easy to grip. Assorted colours.

ORDER NUMBER	UNIT
1 1278 10 CC12	12/PK
2 1278 10 CC24	24/PK



B DERWENT® ACADEMY™ WATERCOLOUR PENCILS

Made with natural wood barrels and quality water-soluble pigments. Easy to sharpen. Includes tin storage case. Assorted colours.

ORDER NUMBER	UNIT
2301942	24/PK

C STAEDTLER® MARS VINYL ERASER

Clean, white non-abrasive eraser in a protective sleeve for use with bond or drafting vellums.



ORDER NUMBER	DESCRIPTION	UNIT
1 526 50 UP	Plastic	EA
2 525 B20	NEW! PVC and Latex free	EA



D STAEDTLER® KARAT® WATERCOLOUR CRAYONS

Professional quality watercolour crayons that offer the utmost in versatility. Dip the crayon directly into water, apply water with a brush, or colour onto a wet area for beautiful and easy watercolour effects. Assorted colours.

ORDER NUMBER	UNIT
223 C12	12/ST

E TOMBOW MONO ZERO ERASER VALUE PACK

Protect your work and erase only what you need with high-quality, precision eraser that will not damage your paper. Two shapes and sizes for correcting your work. Pen-style body is easy to use and store. Includes a round 2.3 mm diameter and ultra-fine precision tip.



ORDER NUMBER	UNIT
57315	PK

F LYRA KNETGUMMI KNEADABLE ERASER

Great for erasing and lightening charcoal, chalk and pastel drawings. It is easy to knead and does not smudge paper. The practical plastic case keeps it pliable.



ORDER NUMBER	UNIT
2091467	EA

G STAEDTLER® ART ERASERS

Kneadable eraser and art gum eraser.



ORDER NUMBER	UNIT
5427SBK2-C	2/CD



H PRISMACOLOR® ARTGUM® ART ERASERS

Block-shaped eraser keeps projects clean and free of smudges and smears.

ORDER NUMBER	DESCRIPTION	UNIT
73030	2"×1"×7/8"	EA

Arts & Crafts – tempera and washable paint



A PRANG® READY-TO-USE TEMPERA PAINT

No shaking or stirring required.
Washable; non-toxic. Colours:

01 Red, **02** Orange, **03** Yellow,
04 Green, **05** Blue, **06** Violet,
07 White, **08** Brown, **09** Black, **10** Magenta.



ORDER NUMBER	DESCRIPTION	UNIT
1	72067-107 473 mL (16 oz.), Specify colour	EA
2	72067-10712 473 mL (16 oz.), Turquoise	EA
3	72067-109 946 mL (32 oz.), Specify colour	EA
4	72067-10912 946 mL (32 oz.), Turquoise	EA
5	72067-106 3.79 L (128 oz.), Specify colour	EA
6	72067-10613 3.79 L (128 oz.), Turquoise	EA



D PRANG® READY-TO-USE TEMPERA PAINT SETS

No shaking or stirring required. Washable and non-toxic.
473ml bottles.

ORDER NUMBER	DESCRIPTION	UNIT
1	72067-10799 4 Neon + 2 Fluorescent colours	6/BX
2	72067-10798 Glitter colours	6/BX
3	72067-10797 Metallic colours	6/BX
4	72067-10796 Classic colours	12/BX



NEW!

B DBLG TEMPERA BLOCKS

Convenient source of opaque water colour and will not deteriorate in storage. They are instantly usable with the addition of water. Colours can be mixed to produce an unlimited range of hues. 58mm x 19mm.

ORDER NUMBER	DESCRIPTION	UNIT
1	49003 Red	6/PK
2	49008 Orange	6/PK
3	49007 Yellow	6/PK
4	49004 Green	6/PK
5	49002 Blue	6/PK
6	49012 Purple	6/PK
7	49001 Black	6/PK
8	49006 White	6/PK

NEW!

C DBLG TEMPERA BLOCK PALETTE



Designed to hold 6 tempera blocks. Made from heavy duty plastic. Stackable

ORDER NUMBER	UNIT
29003	EA



E CRAYOLA® WASHABLE PAINT

Crayola® paints deliver premium quality, vibrant colours and are easily washable. 237 mL. Assorted colours.

ORDER NUMBER	UNIT
54-7408	4/PK



F DEFLECTO® ANTIMICROBIAL KIDS NO SPILL PAINT CUP

Antimicrobial paint cup designed especially for kids. Protect floors, tables, and yourself from paint splatter. Features secure screw-on cap, hinged inner lid and a ridge on the lid holds the brush. Plastic.



ORDER NUMBER	DESCRIPTION	UNIT
1	39515BLU Blue	EA
2	39515RED Red	EA
3	39515YEL Yellow	EA

A CRAYOLA® ART SMOCK WITH SLEEVES

Protection for kids' skin and clothes. Adjustable velcro closure fits kids 3-5 years. 100% polyester easily wipes clean.

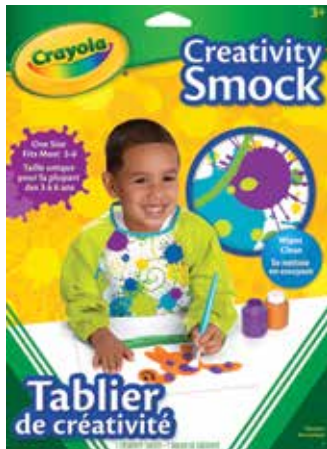

ORDER NUMBER	UNIT
66-3609	EA

B CRAYOLA® BIG PAINT BRUSHES

4 general purpose arts and craft brushes. White synthetic bristle. Colour metal ferrule wood handle with cool metallic sheen. Wide widths for posters, signs, stenciling.



ORDER NUMBER	DESCRIPTION	UNIT
1 05-3619	Round	4/CD
2 05-3618	Flat	4/CD



NEW!

C PRANG® FINGERPAINT PAPER

This glossy white paper is extra strong, coated on both sides and non-absorbent. The smooth, bright surface resists running, smearing and bleeding.

ORDER NUMBER	DESCRIPTION	UNIT
1 P0073620	11"×16"	100/PK
2 P5316	16"×22"	100/PK



D CRAYOLA® KIDS' WASHABLE PAINT SETS

Washable paint in 59 ml jars. For finger painting, posters and banners. Assorted colours.



ORDER NUMBER	DESCRIPTION	UNIT
1 54-1204	6 colours	BX
2 54-1205	10 colours	BX
3 54-1216	6 glitter colours	BX



E CRAYOLA® WASHABLE FINGERPAINT

Bold colours. Washable. Features a thick, creamy consistency that's ideal for developing fine and gross motor skills while experimenting with textures and designs. 8oz. (236ml.)

ORDER NUMBER	UNIT
55-0355	3/PK



F DEFLECTO® FINGER PAINT TRAY

Comes with SteriTouch® Antimicrobial protection for the life of the product. Sturdy tray designed to make craft projects neater. Deep edges keep messes contained. Built-in handles make it easy for little hands to hold & carry. Perfect for painting and collaging. 16"W×12"D×1¼"H. Plastic.

ORDER NUMBER	DESCRIPTION	UNIT
1 39507BLU	Blue	EA
2 39507RED	Red	EA
3 39507YEL	Yellow	EA

A DALER-ROWNEY GEORGIAN WATER MIXABLE OIL PAINTS

High quality mixable paints offering an alternative to traditional oils. 20 ml.



ORDER NUMBER	DESCRIPTION	UNIT
119900150	6 tubes	ST



B STAEDTLER® WATERCOLOUR PAINTS

Easy to blend paints can be mixed with water for colour washes or layered for depth. Use right out of the tube for intense colour. Perfect for fine art and a variety of craft applications on watercolour paper or board. Cleans easily with water.

ORDER NUMBER	DESCRIPTION	UNIT
1 8880 C12	12 tubes	ST
2 8880 C24	24 tubes	ST



C PENTEL ARTS™ WATERCOLOURS

Rich, dramatic colours spread and blend easily to create subtle hues. Dries evenly, resists fading, and will not crack or flake. Ideal for glazing without turning "muddy". Great to use in conjunction with oil pastels and colour pencils. Once colours are dry on palette, they can be re-used when water is applied. Acid-free and Certified by ACMI. 5 mL. Assorted colours.

ORDER NUMBER	DESCRIPTION	UNIT
1 WFRS-12	12/PK	
2 WFRS-24	24/PK	

D STAEDTLER® WATERCOLOUR PANS

Pans come in a sturdy plastic box with mixing tray in the lid. 12 intense colours can be mixed with water to achieve a myriad of watercolour effects. Paint brush and 7.5ml tube of Zinc white included. Perfect for indoor or outdoor painting.

ORDER NO.	DESCRIPTION	UNIT
888 C12A6	12 colours	ST



E PRANG® OVAL WATERCOLOURSETS

Eight or 16 colours. No. 9 brush included.

ORDER NUMBER	DESCRIPTION	UNIT
1 72067-00800	8 colours	ST
2 72067-16000	16 colours	ST



F CRAYOLA® WASHABLE WATERCOLOURS

Assorted Colours. 24 colours.

ORDER NUMBER	DESCRIPTION	UNIT
53-2400	24 colours	ST

G PRANG® WASHABLE WATERCOLOURS

Non-toxic. Washable. Semi-moist for long lasting colour. Brush included. Assorted colours.

ORDER NUMBER	DESCRIPTION	UNIT
1 72067-16016	16 Classic colours	ST
2 72067-80515	8 Glitter colours	ST
3 72067-80516	8 Metallic colours	ST



A DERWENT® ACADEMY™ ACRYLIC PAINTS

Great for craft painting. Can be used to paint on all conventional acrylic painting surfaces. 12 ml tubes. Assorted colours.



ORDER NUMBER	DESCRIPTION	UNIT
98226	24 tubes	ST

C STAEDTLER® ACRYLIC PAINTS

Paint tubes contain 12ml. of highly pigmented, brilliant paint colours which are water soluble prior to drying. Laydown thick for texture, layering and impressive brush marks. Can be thinned for subtle washes. Certified non-toxic.



ORDER NUMBER	DESCRIPTION	UNIT
1 8500 C12	12 colours	ST
2 8500 C24	24 colour	ST

D LIQUITEX® BASICS ACRYLIC PAINTS

Liquitex Basics series in 22 ml tubes, for students and artists that need dependable quality at an economical price.



ORDER NUMBER	DESCRIPTION	UNIT
101501	Set of 6 tubes	ST

E LIQUITEX BASICS® ACRYLIC PAINTS

Brilliant colour, high levels of pigment strength, opacity and permanence. 250ml.

ORDER NUMBER	DESCRIPTION	UNIT
1 4385127	Burnt sienna	EA
2 4385128	Burnt umber	EA
3 4385720	Cadmium orange hue	EA
4 4385311	Cadmium red deep hue	EA
5 4385151	Cadmium red med. hue	EA
6 4385163	Cadmium yel. deep hue	EA
7 4385160	Cadmium yel. light hue	EA
8 4385161	Cadmium yel. med. hue	EA
9 4385470	Cerulean blue hue	EA
10 4385170	Cobalt blue hue	EA
11 4385186	Dioxazine purple	EA
12 4385244	Ivory black	EA
13 4385276	Mars black	EA
14 4385316	Phthalocyanine blue	EA
15 4385317	Phthalocyanine green	EA
16 4385330	Raw sienna	EA
17 4385432	Titanium white	EA
18 4385380	Ultramarine blue	EA



B WINSOR & NEWTON® GALERIA ACRYLIC COLOURS

Brilliant colour, high levels of pigment strength, opacity & permanence. 60 ml.

ORDER NO.	DESCRIPTION	UNIT
1 2120074	Burnt sienna	EA
2 2120076	Burnt umber	EA
3 2120077	Burnt sienna opaque	EA
4 2120090	Cadmium orange hue	EA
5 2120095	Cadmium red hue	EA
6 2120114	Cadmium yel. pale hue	EA
7 2120115	Cadmium yel. deep hue	EA
8 2120120	Cadmium yel. med. hue	EA
9 2120138	Cerulean blue hue	EA
10 2120179	Cobalt blue hue	EA
11 2120203	Crimson	EA
12 2120257	Pale rose blush	EA
13 2120311	Hookers green	EA
14 2120331	Ivory black	EA
15 2120337	Lamp black	EA
16 2120346	Lemon yellow	EA
17 2120386	Mars black	EA
18 2120415	Mixing white	EA
19 2120435	Pale olive	EA
20 2120438	Pale umber	EA
21 2120446	Powder blue	EA
22 2120447	Olive green	EA
23 2120448	Opera rose	EA
24 2120465	Payne's grey	EA
25 2120466	Perm. alizaron crimson	EA
26 2120482	Permanent green deep	EA
27 2120483	Permanent green light	EA
28 2120488	Permanent magenta	EA
29 2120502	Permanent rose	EA
30 2120516	Phthalo blue	EA
31 2120522	Phthalo green	EA
32 2120541	Prussian blue hue	EA
33 2120552	Raw sienna	EA
34 2120554	Raw umber	EA
35 2120599	Sap green	EA
36 2120644	Titanium white	EA
37 2120653	Transparent yellow	EA
38 2120660	Ultramarine	EA
39 2120676	Vandyke brown	EA
40 2120682	Vermilion hue	EA
41 2120706	Winsor blue	EA
42 2120728	Winsor violet	EA
43 2120744	Yellow ochre	EA
METALLIC		
44 2120283	Gold	EA
45 2120617	Silver	EA

A DERWENT® ACADEMY™ PAINT KNIVES

Straight knives are great for blending paint on a palette to create different shades while bent knives work well for applying paint directly to surfaces. Ideal for use with acrylic and oil paints. Durable plastic construction.



ORDER NUMBER	UNIT
98246	4/PK

B WINSOR & NEWTON® ARTISTS' ACRYLIC VARNISHES

A protective layer over finished art. UV agent improves light fastness. Use on acrylic, oil and alkyd paintings (fully cure paint before applying.) 225ml.



ORDER NUMBER	DESCRIPTION	UNIT
1 3040929	Gloss	EA
2 3040930	Matte	EA
3 3040931	Satin	EA



C CANSON® DISPOSABLE PALETTE

Smooth, coated surface. For all paints and solvents. Eliminates messy clean up compared to traditional palettes. 40 sheets/pad. 9"×12".

ORDER NUMBER	UNIT
100510953	EA



D DEFLECTO® PAINT SAVER PALETTE WITH MIXING TRAY AND LID

Airtight and leak-proof to keep watercolour and oil paints fresh and ready to use. Non-porous material. 18 painting wells and mixing areas. Clear, removable mixing tray stores in lid. Polypropylene. 5"W×10²/₃"D×³/₄"H.

ORDER NUMBER	UNIT
29507	EA

E DEFLECTO® 19 WELL PAINTER'S PALETTE

Non-porous material cleans up quickly. For acrylic and oil paints. Removable lid with snap tight closures. Airtight design keeps paints fresh and ready to use. 15 small paint wells and 4 large mixing areas. Polypropylene. 13¹/₃"W×9¹/₃"D×1¹/₃"H.

ORDER NUMBER	UNIT
29511	EA



F DEFLECTO® PAINT TRAY

Non-porous material cleans up quickly. Paints peel off easily. For acrylic and oil paints. With 9 small paint wells, 2 large mixing areas, and comfortable thumb indentations for easy left or right-handed grip. Polypropylene. 8⁷/₁₀"W×13⁸/₁₆"D×³/₁₆"H.

ORDER NUMBER	UNIT
29510	EA



G DERWENT® ACADEMY™ METAL PAINT PALETTE

Palette has 10 wells for holding and mixing paints. Durable metal construction. Plastic lid is great for storing unused paint between uses.

ORDER NUMBER	UNIT
98244	EA

NEW!



H DBLG PLASTIC PAINT PALETTE

10 rounded wells around a center well. Studded perimeter.

ORDER NUMBER	UNIT
29002	EA

**A DBLG
FLAT BRISTLE BRUSHES**

A good entry level brush that can be used with a variety of mediums. Hog hair bristles.

ORDER NUMBER	DESCRIPTION	UNIT
1 29122	#2	EA
2 29124	#4	EA
3 29126	#6	EA
4 29128	#8	EA
5 29130	#10	EA
6 29132	#12	EA



**C DBLG
ROUND BRISTLE BRUSHES**

Terrific for watercolours. Can be used with a variety of mediums. Camel hair bristles.

ORDER NUMBER	DESCRIPTION	UNIT
1 29401	#1	EA
2 29402	#2	EA
3 29408	#8	EA
4 29410	#10	EA
5 29412	#12	EA



**E DERWENT
ACADEMY™ PAINT
BRUSHES**

Great for use with acrylic, oil and watercolour paints as well as other wet media. High-quality bristles are made of all-natural fibres that are securely embedded in the brush. Round wash brushes are great for making large, consistent strokes. Squared ends are able to make fine lines.



ORDER NUMBER	DESCRIPTION	UNIT
1 98250	Wash brush set: 3 flat	3/PK
2 98238	Artist brush set: 3 round, 2 flat, 1 liner, 1 mop brush, 1 fan brush	8/PK

**G DEFLECTO® PAINTER'S COMPANION WATER
BUCKET WITH HANDLE**

Three deep reservoirs provide areas to clean, mix and organize brushes, plus an area to hold a wiping cloth for dabbing. Handle folds down to hold brushes when not in use. Nestable. Plastic. 2.3 L. 11½"W×7¾"D×5¼"H.

ORDER NUMBER	UNIT
29506	EA

**B LIQUITEX®
BASICS
ACRYLIC
BRUSH SET**

White nylon artist acrylic brushes.



ORDER NUMBER	DESCRIPTION	UNIT
LONG HANDLE		
1 692002	#2 and #3 round, #2 filbert, #3 bright and #2 flat	5/ST
2 692003	#4 filbert, #6 round, #4 and #8 bright	4/ST
SHORT HANDLE		
3 692001	#1 and #4 round, #2 flat, #4 fan, #3 and #6 bright	6/ST

D PRANG® HOBBY BRUSHES

Soft, synthetic bristles for clean paint applications. Washes easily with soap and water. Includes two flat and three round brushes.

ORDER NUMBER	DESCRIPTION	UNIT
72067-94005	#6, #10 flat, #3, #6 & #10 round	5/PK



**F STAEDTLER® SYNTHETIC
BRUSHES**

For use with watercolours, acrylic, gouache, oil and water soluble pencil crayons and chalks. Brushes feature excellent elasticity and shape retention. Durable synthetic fibre wood handle with metal ferrule. Made in Germany.

ORDER NUMBER	DESCRIPTION	UNIT
989-SBK3-3	Round #2,8; Flat#8	3/CD



Check online for the most current price.



A SHEAFFER® CALLIGRAPHY MINI KIT

Each kit includes one pen with three interchangeable nib grades, four ink cartridges (Jet Black, Blue, Red, Green) and an instruction booklet.

ORDER NUMBER	UNIT
74040-83403	EA



B SHEAFFER® CALLIGRAPHY KIT

Three pens, three interchangeable nib grades, and 20 ink cartridges.

ORDER NUMBER	UNIT
74040-00545	EA



C SHEAFFER® SKRIP® INK

For all makes of fountain pens. Colours: **21** Blue, **31** Jet Black.

ORDER NUMBER	DESCRIPTION	UNIT
74040-942	53 ml bottle	EA



D SPEEDBALL® CALLIGRAPHY PEN SET

Ideal set for beginners. Use for Roman text, Italic alphabets, ornamental work or fine lettering. Contains 4× C Style Pen Nibs (C1, C2, C3, C4); 2× Pen Points (No. 101 and No. 512); 1× Pen Nib Holder.

ORDER NUMBER	UNIT
2961	EA



E SPEEDBALL® ARTIST PEN SET

Includes: 2× Pen Nib Holders; 3× BStyle Pen Nibs (B1, B3, B5); 3× C Style Pen Nibs (C0, C2, C4), 3× Pen Points (No. 102 Crow Quill, No. 56, No. 513EF). Great for lettering, calligraphy, poster-making, sketching, cartooning and mapping.

ORDER NUMBER	UNIT
2962	EA



F SPEEDBALL® SKETCHING PEN SET

Excellent for drawing, sketching, lettering and cross-hatching, this set contains: 2× Pen Nib Holders; 6× Pen Points (No. 99, No. 56, No. 102 Crow Quill, No. 107 Hawk Quill, No. 108, No. 512).

ORDER NUMBER	UNIT
2964	EA

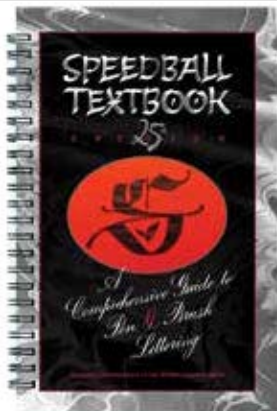

G THE SPEEDBALL® TEXTBOOK

Contains a wealth of lettering examples and styles. Also outlines nibs selection for varying styles of work, spacing recommendations, design information, and offers samples of some of today's best calligraphy.

ORDER NUMBER	UNIT
3073	EA



H SPEEDBALL® 10-COLOUR CALLIGRAPHY INK PALETTE

Kit includes 9" round white plastic palette and 12ml ink glass jars with ten different vibrant colours: black, red, blue, green, brown, gold, teal, silver, purple and white. Perfect for scrapbooks, journals, drawing, sketching, and much more. Acid free, archival quality, waterproof and non-toxic.

ORDER NUMBER	UNIT
3132	ST



I SPEEDBALL® PEN CLEANER

A highly effective cleaning agent for brushes, nibs and jewelry. Excellent with Acrylic and India Inks.

ORDER NUMBER	DESCRIPTION	UNIT
3159-SPE	2 oz./59.1 ml	EA



A SPEEDBALL® SUPER VALUE CALLIGRAPHY KIT

All-in-one kit includes the essentials to get started in drawing, lettering or calligraphy. Great for beginners and students. Includes 1 each of the following: 2oz (59.1ml) Super Black India Ink and Pen Cleaner; 41oz (12ml) Super Pigmented Acrylic Drawing and Lettering Ink (Silver); C1, C2, B4, and A5 Pen Nibs; Speedball® Pen Nib Holder; Speedball® Elementary Alphabets Instruction Book; practice paper.

ORDER NUMBER	DESCRIPTION	UNIT
3060	Super Value kit	EA



B ITOYA® DOUBLEHEADER® CALLIGRAPHY MARKER

Double-ended marker; contains water-soluble and acid free ink. Chisel tips, 1.5 mm and 3 mm. Colours **BK** Black, **BU** Blue, **GN** Green, **PK** Pink, **PU** Purple, **RD** Red.

ORDER NUMBER	DESCRIPTION	UNIT
1 CL-10-__	Specify colour	EA
2 CL-100	Set of 6 colours	ST



C BIENFANG® CALLIGRAPHY PRACTICE PAPER PAD

Glue-bound pad contains 50 sheets of smooth surface texture paper that is ideal for practicing all calligraphic lettering techniques. 19lb. Lined paper.

ORDER NUMBER	DESCRIPTION	UNIT
R400145	9"×12"	EA



D BIENFANG® CALLIGRAPHY PARCHMENT PAPER

Excellent, fine surface texture paper specifically designed for use with pen and ink. Each package contains 50 sheets of 60lb, acid-free paper.

ORDER NUMBER	DESCRIPTION	UNIT
R400127	8½"×11", White	50/PK

E SPEEDBALL® SUPER BLACK INDIA INK



Made from highly opaque, carbon black pigment, Super Black India Ink offers excellent reproduction quality on absorbent surfaces with optimum lightfastness. Easily applied by brush, pen, steel brush or air brush. Free-flowing, non-clogging and waterproof.

ORDER NUMBER	DESCRIPTION	UNIT
3338	2 oz./59.1 ml	EA



F WINSOR & NEWTON® BLACK INDIAN INK

For illustrators, designers, calligraphers and artists. Made from a lightfast pigment dissolved in a superior shellac solution. For brush and dip pens.

ORDER NUMBER	DESCRIPTION	UNIT
1005030	14 ml bottle	EA

Check online for the most current price.



A DEFLECTO® STACKABLE CADDY ORGANIZER BUNDLE

Roll your stacked caddies wherever you need them by snapping on the Caddy Wheel Base. Caddy containers hang on the 22" wall mounting bar for easy access without cluttering your workspace. Includes 3 stackable caddy organizers (14"W×6.5"H×10.5"D), Stack 'N Go wheel base (16"W×3¼"H×11"D) and wall mounting bar.

ORDER NUMBER	DESCRIPTION	UNIT
329003BB	White and clear	EA



B DEFLECTO® STORAGE ORGANIZER

Transparent storage organizer with three divided drawers to keep supplies organized. Compact and stackable. Non-skid pads on bottom aid in stacking and protect work space surface.

ORDER NUMBER	DESCRIPTION	UNIT
350901CR	10"W×6.8"L×7"H.	EA



D DEFLECTO® INTERLOCKING TILT BIN

Interlocking dovetail design stacks and connects vertically or horizontally. Bins tilt out effortlessly and stay open when not in use. Removable for easy cleaning and refilling. Use on table, mount direct to wall, hang on mounting bar (22773CR sold separately) or underneath cabinets. Clear and White.

ORDER NUMBER	DESCRIPTION	UNIT
421103	4¾"W×5¼"D×5½"H	4/PK



C DEFLECTO® CADDY ORGANIZER SYSTEM

Integrated handle/locking system allows for on the go storage. Removable storage containers with hinged snap tight lids. Each compartment also mounts on the wall using a mounting bar system for versatile storage.

ORDER NUMBER	DESCRIPTION	UNIT
1 29443CR	Caddy wheel base, white	EA
2 29003CR	Caddy, white	EA
3 29101CR	Small compartment, clear	EA
4 29201CR	Medium compartment, clear	EA
5 29301CR	Large compartment, clear	EA

DEFLECTO® CADDY ORGANIZER SYSTEM MOUNTING BAR

For wall mount applications. Screws and anchors included.

ORDER NUMBER	DESCRIPTION	UNIT
6 22773CR	Aluminum wall mount bar	EA



E DEFLECTO® STACKABLE CUBE ORGANIZERS

Modular organizers stack together with clips (included) for a custom system. Removable drawers and dividers. Plastic.

ORDER NUMBER	DESCRIPTION	UNIT
1 350101	2-drawer, 6"W×7¼"D×6"H	EA
2 350201	"X" divider, 6"W×6"×6"	EA
3 350301	4-drawer, 6"W×7¼"D×6"H	EA
4 350701	Divided shelf, 6"×6"×6"	EA



A DEFLECTO® SINGLE TRAY STORAGE BOX

Compact, yet spacious with lots of storage to keep supplies organized. Space-saving and stackable. Features lift-out tray with separate storage areas, sturdy latch, and a bottom compartment with ample storage capacity. Plastic. 7½"W×14½"D×5½"H.

ORDER NUMBER	DESCRIPTION	UNIT
29601	White	EA



B DEFLECTO® THREE TRAY STORAGE BOX

Multi-purpose storage box with three tiered trays. Features 3 lid-access storage areas, top tray with adjustable dividers, deep lower compartments, sturdy latch and carrying handle. Plastic. 9"W×16¼"D×8¾"H.

ORDER NUMBER	DESCRIPTION	UNIT
29505	Grey and White	EA



C DEFLECTO® ANTIMICROBIAL LAP DESK

Create a comfortable activity station for kids at home, outside, or on long road trips with all-in-one creative activity tray. Features a flat center surface to place books and papers, and deep side compartments for supplies. Durable, lightweight and easy to transport. Plastic. 11¼"W×23¾"D×8½"H.

ORDER NUMBER	DESCRIPTION	UNIT
1 39502BLU	Blue	EA
2 39502RED	Red	EA
3 39502YEL	Yellow	EA



D DEFLECTO® ANTIMICROBIAL STORAGE BOXES

Perfect for pencils, markers or art and craft supplies. Features a snap shut lid. Colours: **BLU** Blue, **RED** Red, **YEL** Yellow.

ORDER NUMBER	DESCRIPTION	UNIT
1 39504	5½"W x 7½"D x 2¼"H	EA
2 39506	10½"W x 8½"D x 2½"H	EA

E BANKERS BOX® MAGAZINE FILES

Stores and organizes letter size materials. Contains 60% recycled material. Assorted Red, Blue & Yellow pack.



ORDER NUMBER	DESCRIPTION	UNIT
3381701	12¾"H×4"W×11"D	3/PK



F BANKERS BOX® 9-COMPARTMENT CLASSROOM CUBBY

Sturdy multi-layered construction for lasting performance. Nine compartments hold oversized books and teaching materials. Contains 60% recycled material. SFI certified. Blue.



ORDER NUMBER	DESCRIPTION	UNIT
3380701	16"H×28¼"W×13"D	EA

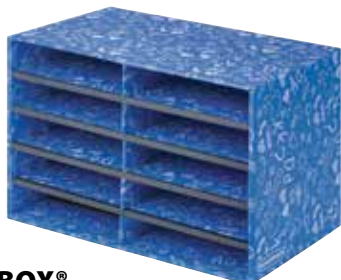

G BANKERS BOX® CLASSROOM LITERATURE SORTERS

Stores, protects and organizes supplies in the classroom. Premium multi-layer construction with labels for quick identification. Easy assembly.

ORDER NUMBER	DESCRIPTION	UNIT
3384201	10 compartment, 26¼"W×18¾"D×16¾"H	EA



H BANKERS BOX® CLASSROOM STACKABLE LITERATURE SORTERS

Stores, protects and organizes supplies in the classroom. Premium multi-layer construction with labels for quick identification. Easy assembly.

ORDER NUMBER	DESCRIPTION	UNIT
1 3384301	15 compartment, 29¼"W×12¾"D×9¾"H	EA
2 3384401	30 compartment, 29¼"W×12¾"D×18¾"H	EA





A STOREX® ART CADDY

Impact resistant plastic, washable and dishwasher safe. Caddy features 1 large and 2 small compartments and a carry handle. Large. 12¾"L×11¼"W×5½"H

ORDER NUMBER	DESCRIPTION	UNIT
1 00953U06C	Blue	EA
2 00954U06C	Red	EA
3 00955U06C	Purple	EA
4 00956U06C	Green	EA
5 00957U06C	Yellow	EA
6 00959U06C	Teal	EA



B STOREX® BOOK BINS

Book Bin will hold large books, magazines, file folders, etc. Sides of bins connect together for safe storage and have front and rear handles for easy gripping. 14"L×5¼"W×7¼"H.

ORDER NUMBER	DESCRIPTION	UNIT
1 70105U06C	Assorted colours	5/PK
2 70109B06C	Black	EA



D STOREX® STORAGE BINS

Organize and store supplies. Front and rear handles for easy gripping. Plastic.

ORDER NUMBER	DESCRIPTION	UNIT
15 L, 13¾"W×11¼"D×7¾"H		
Colours: 51 Blue, 52 Red, 53 Yellow, 77 Teal, 81 Purple, 80 Green.		
1 614__U06C	Specify colour	EA
21 L, 16¾"W×11¾"D×8¼"H		
Colours: 82 Blue, 83 Red, 84 Yellow, 78 Teal, 86 Purple, 85 Green.		
2 614__U06C	Specify colour	EA



C DEFLECTO® ANTIMICROBIAL KIDS MINI TOTE

Perfect holder for crayons, googly eyes, and other art supplies so little ones can be creative anywhere. Features built-in, easy-grip handle. Plastic. 6.89"×2.91"×6.57".



ORDER NUMBER	DESCRIPTION	UNIT
1 39501BLU	Blue	EA
2 39501RED	Red	EA
3 39501YEL	Yellow	EA



E STOREX® CUBBY BINS

Bins fit standard classroom cubbies. Durable plastic. 7¼"S×12½"L×5⅛"H. Colours: **07** Red, **08** Blue, **09** Green, **10** Yellow, **11** Purple, **12** Teal.

ORDER NUMBER	DESCRIPTION	UNIT
624__U05C	Specify colour	EA



F STOREX® CUBBY BIN RACK

Complete stand alone storage solution that is colour coded to help organize classrooms, crafts or art supplies. 12-Slot. Includes 12 bins in assorted colours. Bins made from sturdy, drip-resistant plastic. 27¼"S×13⅓"D×27½"H.

ORDER NUMBER	UNIT
62488E01C	EA



A HILROY EXERCISE BOOKS

Stitched binding. Contains 30% post-consumer material.



ORDER NUMBER	DESCRIPTION	UNIT
--------------	-------------	------

9 1/8" x 7 1/8", 72 PAGES

1	43100-12150	Half plain, half ruled	EA
2	43100-12154	Plain	EA
3	43100-12901	Ruled with margin	EA
4	43100-12152	Dotted interlined with margin	EA
5	43100-12155	Half plain, half interlined	EA

9 1/8" x 7 1/8", 40 PAGES

6	65800-11969	Dotted interlined with margin 4mm ruling	EA
7	65800-11975	8mm ruling with margin	EA
8	65800-11935	Half plain, half interlined	EA
9	65800-11925	Interlined with margin	EA

9 1/8" x 7 1/8", 80 PAGES

10	65800-11985	8mm ruling with margin	EA
----	-------------	------------------------	----

10 7/8" x 8 3/8", 40 PAGES

11	65800-11175	8mm ruling with margin	EA
----	-------------	------------------------	----

10 7/8" x 8 3/8", 80 PAGES

12	65800-11185	8mm ruling with margin	EA
----	-------------	------------------------	----



B INNOVATIVE TEACHER DAILY PLAN BOOKS

Features colour-coded separate plan and record sections. Includes daily planning pages, record section, time tables, seating plans, meetings and more. 1 page per day. English. Coil bound. 8 1/2" x 11".

ORDER NUMBER	DESCRIPTION	UNIT
1	01-0100	Elementary
2	02-0100	Secondary



C HILROY RULED NOTEBOOKS

Ruled pages with subject header, date and page number box. Index page printed on interior cover. Sticker page with tab divider and reminder stickers. Ruled. Coil bound. 10 1/2" x 8". Assorted colours.

ORDER NUMBER	DESCRIPTION	UNIT
65800-13048	200 pages	EA



D HILROY STITCHED EXERCISE BOOKS

Ruled 7mm with margin, white paper, 3-hole punched. Ideal for school and home use. Lightweight covers in assorted colours. 10 1/8" x 8 3/8".

ORDER NUMBER	DESCRIPTION	UNIT
1	65800-12102	40 pages 4/PK
2	65800-12107	80 pages 3/PK



E U BRANDS® DOUBLE-SIDED DRY ERASE LAP BOARD

Perfect tool for students to solve problems individually and hold the answers up high to share with the teacher & classroom. Ghost-resistant surface erases easily on both sides. Lined on one side and blank on the other. Rounded edges ensure safe use for children.

ORDER NUMBER	DESCRIPTION	UNIT
483U00-01	9" x 12"	10/PK

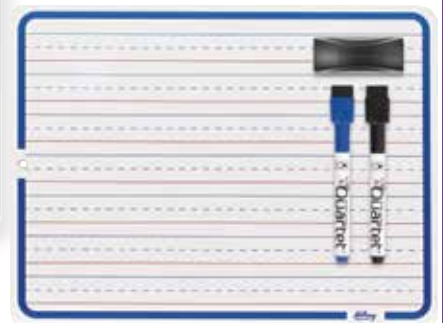

F HILROY DOUBLE-SIDED DRY ERASE LAP BOARD

A double sided dry erase board that mimics a Hilroy exercise book with one side blank and one side interlined. Includes two Quartet® dry-erase markers and one eraser.

ORDER NUMBER	DESCRIPTION	UNIT
64474-15847	8 1/2" x 11"	EA



A DIXON® CLASSMATE® PENCILS

Designed to meet the special needs of both student and teacher. Lead is specially formulated to lessen smear and effort.



ORDER NUMBER	DESCRIPTION	UNIT
72067-14009	HB	144/BX



C TICONDEROGA® TRI-WRITE™ PENCILS

Ergonomically perfect, triangular-shaped pencil for exceptional comfort and fatigue free-writing. Latex free pink eraser. Certified non-toxic.

ORDER NUMBER	DESCRIPTION	UNIT
72067-13856	HB	12/BX



E DIXON® PRIMARY PRINTER PENCILS

The beginners' choice for that important first pencil. Oversized diameter makes the Primary Printer easy for little hands to hold.

ORDER NUMBER	DESCRIPTION	UNIT
1 72067-18997	#1, 1 1/2" diameter	12/BX
2 72067-18995	#2, 1 1/2" diameter	12/BX



H DIXON® ERASERS

ORDER NUMBER	DESCRIPTION	UNIT
1 72067-77001	Medium #100	EA
2 72067-77003	Large #101	EA
3 72067-79003	Wedge tip #1212	25/BX
4 72067-39700	White Vinyl Pearl medium	EA
5 72067-39701	White Vinyl Pearl large	EA
6 72067-38965	Mini Neon NEW!	5/PK

J WINNABLE VINYL ERASER

Soft white plastic eraser that is age resistant. 2 1/2" x 1/2" x 1".

ORDER NUMBER	UNIT
40015	20/BX

Our Brand, YOUR Savings!



B OP BRAND PENCILS

Premium HB pencils with eraser tip.

ORDER NUMBER	DESCRIPTION	UNIT
27811-50004	HB	12/BX



D STAEDTLER® WOODCASED PENCILS

Pre-sharpened yellow school woodcased pencils. Latex free eraser tip. Easy to sharpen. HB/#2. FSC® Certified.

ORDER NUMBER	DESCRIPTION	UNIT
1 13247C12A6	HB	12/BX
2 13247C144A	Class Pack	144/BX



F DIXON® TICONDEROGA® PREMIUM GRAPHITE CORE PENCILS

Lead grades: 2 HB, 4 2H, 5 F.

ORDER NUMBER	DESCRIPTION	UNIT
1 72067-1388	Unsharpened, Specify grade	12/BX
2 72067-13830	Pre-sharpened, HB	30/BX



G STAEDTLER® MY FIRST NORICA JUMBO PENCIL

Learner's pencil in an ergonomic triangular shape encourages a correct grip. High break-resistance through special lead formulation. Wood from FSC® certified, sustainably managed forests.

ORDER NUMBER	DESCRIPTION	UNIT
119 22	4MM, HB	12/BX



I PRISMACOLOR® COL-ERASE® PENCIL

Features vivid, easily-erasable pigments and an eraser that allows for easy correction. Perfect for illustrating, animating and designing, the medium point delivers intense, rich colour laydown.

ORDER NUMBER	DESCRIPTION	UNIT
20045	Carmine red	12/BX



A OXFORD® CANADIAN DICTIONARY OF CURRENT ENGLISH

Paperback; 7"×4½".

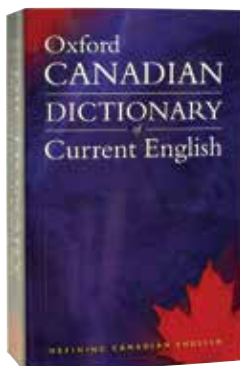

ORDER NUMBER	UNIT
9780195422832	EA

B OXFORD® ESSENTIAL FRENCH DICTIONARY

French-English, English-French. Paperback. 7"×4½".

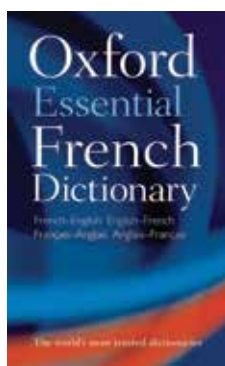

ORDER NUMBER	UNIT
9780199576388	EA

C OXFORD® CANADIAN THESAURUS OF CURRENT ENGLISH

Paperback; 7¼"×4½".

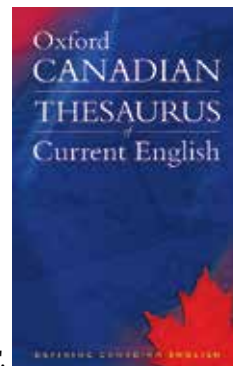

ORDER NUMBER	UNIT
9780195425697	EA



D TRODAT® PRINTY 4911 TEACHER STAMPS

Designed to provide feedback and motivation. Contains a minimum of 65% post-consumer recycled content. Lifetime warranty. English.

ORDER NUMBER	DESCRIPTION	UNIT
1 97071	Beautiful Work!	EA
2 97075	Good Listener!	EA
3 97074	Neat Writing!	EA
4 97072	SUPER!	EA
5 97076	You did it!	EA
6 97073	VERY COOL!	EA



E DURAPOLY® CANADA FLAGS

Knitted polyester for maximum durability. Printed with fade resistant inks. Features a heavy duty header with two brass grommets.

ORDER NUMBER	DESCRIPTION	UNIT
1 50-34005427Q	54"×27"	EA
2 50-34007236Q	72"×36"	EA



F TRODAT® 4911 SELF-INKING TEACHER STAMPS

Ideal when sending homework home for parent's signature. Contains up to 65% post-consumer recycled material. Non-toxic water-based ink. Lifetime warranty on mechanism.

ORDER NUMBER	DESCRIPTION	UNIT
1 97057	Parent Signature Stamp	EA
2 67678	Replacement ink pad, Blue	EA



G TRODAT® 4922 SELF-INKING TEACHERS' STAMPS

Stamps are water-based and non-toxic.

ORDER NUMBER	DESCRIPTION	UNIT
1 05396	"Excellent"	EA
2 05398	"Good Homework"	EA
3 05399	"Much Improved"	EA
4 05420	"Outstanding"	EA
5 05422	"Very Good"	EA
6 97332	Replacement ink pad, Red (6/4922)	EA

H X-ACTO® SCHOOL PRO® ELECTRIC PENCIL SHARPENER

Stops when the shavings bin is removed. Stops sharpening when the pencil reaches ideal sharpness. Coloured pencil compatible. Slip resistant bottom and extra large shavings bin.



ORDER NUMBER	UNIT
1670XT	EA



I BOSTITCH® ANTIMICROBIAL MANUAL PENCIL SHARPENER

Antimicrobial protected. Features dual cutters which can be easily removed for cleaning or replacement. Prevents over sharpening. Durable, all metal design. Large capacity shavings receptacle. Includes screws for mounting.



ORDER NUMBER	UNIT
MPS1-BLK	EA

A STAEDTLER® 10-PIECE MATH SET

In metal box.

ORDER NUMBER	UNIT
557 10 BN	ST



C STAEDTLER® 9 PIECE SCHOOL KIT

Plastic storage case contains Mars plastic mini eraser, 0.5mm mechanical pencil, plastic 45° and 60° set squares, 6" ruler and metal compass with universal adaptor.

ORDER NUMBER	UNIT
550 60S9	ST

F WESTCOTT® PROTRACTOR

4" base, 180° coverage. Clear acrylic plastic.



ORDER NUMBER	UNIT
65956-00480	EA

NEW!

H WESTCOTT® GEOMETRY STENCIL

Precise stencil for all your geometry needs. Twenty-four geometry shape openings. Imperial scale in 16ths and 8ths. Metric scale in millimeters, numbered in centimeters.

ORDER NUMBER	UNIT
KT-95	EA



B WESTCOTT® KLEENEARTH® RULER

Contains an antimicrobial agent to inhibit the growth of bacteria, stains, and odours. Contains a minimum of 30% post-consumer recycled material. Plastic.

ORDER NUMBER	DESCRIPTION	UNIT
65956-41015	12" (30 cm)	EA

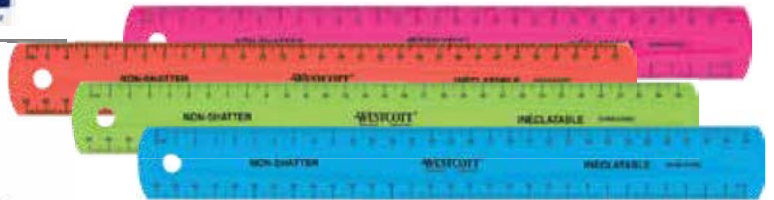

D WESTCOTT® NON-SHATTER RULER

Assorted translucent colours allow for easy viewing through to the page. Shatter-proof plastic.

ORDER NUMBER	DESCRIPTION	UNIT
65956-14381	30 cm	ST



E WESTCOTT® SUPERFLEX RULER

Ultra flexible vinyl ruler. Assorted translucent colours and double beveled. One edge scaled in millimetres and the order edge in centimetre markings.

ORDER NUMBER	DESCRIPTION	UNIT
65956-04530	30 cm	EA



G WESTCOTT® ANTIMICROBIAL WAVE RULER

Plastic parts contain an antimicrobial agent to help inhibit the growth of bacterial odours. One edge scaled in centimetre and millimetre graduations. 3 binder holes. Soft touch non-slip surface. Plastic. Blue and Grey.

ORDER NUMBER	DESCRIPTION	UNIT
65956-14197	30 cm	ST



I WESTCOTT® RULERS

ORDER NUMBER	DESCRIPTION	UNIT
1 65956-11244	6" / 15 cm Flexible clear acrylic	EA
2 65956-20020	12" / 30 cm Flexible clear acrylic	EA
3 65956-16930	30 cm Wood with bevel	EA
4 65956-31530	30 cm Flat wood	EA



A WESTCOTT® SOFT GRIP LEFTY SCISSORS

Designed specifically for left-handed cutters. Inlaid stainless steel blades for precision & safety. Soft grip inserts for added comfort. 5". 5-year warranty. Red.

ORDER NUMBER	DESCRIPTION	UNIT
1 65956-14728	5", pointed tip	EA
2 65956-14774	7", pointed tip	EA



C WESTCOTT® KLEENEARTH® SCISSORS

Handles contain an antimicrobial agent. Plastic components contain 20% post-consumer content. Stainless steel blades. 10 year warranty.

ORDER NUMBER	DESCRIPTION	UNIT
1 65956-14835	5", blunt tips, 4 assorted colours	EA
2 65956-14834	7", pointed tips, Green	EA



D WESTCOTT® X-RAY™ ANTIMICROBIAL SCISSORS

Ultra durable polycarbonate handle with soft grip inserts for added comfort. For left or right hand use. Handles contain an antimicrobial agent. 3 assorted colours. Lifetime warranty.

ORDER NUMBER	DESCRIPTION	UNIT
1 65956-14596	5", blunt tip	EA
2 65956-14597	5", pointed tip	EA
3 65956-66094	7", pointed tip	2/PK

NEW!

F WESTCOTT® KLEENCUT KID'S SCISSORS

Comfortable scissors for small hands. Rounded or pointed tips. Assorted colours. 5 year warranty.



ORDER NUMBER	DESCRIPTION	UNIT
1 65956-40005	5", blunt tip	EA
2 65956-40025	5", pointed tip	EA

NEW!

B BANKERS BOX® AT PLAY™

Use markers, crayons or paint to decorate playhouse any way you want. Corrugated board with kid-friendly rounded edges provides strength and safety for hours of play. Easy two-piece assembly. Operable windows and doors. 32"W×38"D×48"H.

ORDER NUMBER	DESCRIPTION	UNIT
1 1230101	Unicorn	EA
2 1230201	Treats 'N Eats	EA
3 1230301	Color Your House	EA
4 1231401	Castle Playhouse	EA

NEW!

E BANKERS BOX® AT PLAY™ COLOUR IN TOY BOX

Decorate toy box anyway you want - making clean up time fun. Fits Bankers Box 40 pack block set, stuffed animals, sporting gear, books, blankets, pillows, clothes, and other misc. kids items. Features FastFold quick and easy assembly with strong single wall, double bottom construction. Rolled edge to add strength and a premium feel to avoid paper cuts. 18"W×18"D×28"H.

ORDER NUMBER	DESCRIPTION	UNIT
1 1231701	Animal	EA
2 1231601	Sports	EA

NEW!

G BANKERS BOX® AT PLAY™ BUILDING BLOCKS

Fun and durable, large and medium-sized cardboard building blocks. 2 sizes and 3 colours. Holds up to 150 lb. Strong and safe construction, lightweight, rounded edges, bright primary colours featuring brick pattern. Lead-free design. Easy to assemble. Large: 12"W×3"D×6"H Medium: 6"W×3"D×6"H.

ORDER NUMBER	UNIT
1 1230802	20/PK
2 1230801	40/PK



A CRAYOLA® CHALK

ORDER NUMBER	DESCRIPTION	UNIT
1 51-0312	White	12/BX
2 51-0812	Assorted colours	12/BX
3 51-1406	White	144/BX



C WESTCOTT® CHALK HOLDER

Pen-style chalk holder keeps hands cleaner and prevents chalk from breaking.

ORDER NUMBER	DESCRIPTION	UNIT
65956-03504	Aluminum	EA



E WESTCOTT® CHALKBOARD ERASER

Deluxe felt eraser for use on black or green chalkboards. Cleans easily with a vacuum cleaner.

ORDER NUMBER	UNIT
65956-21104	EA



G OP BRAND DRY ERASE MARKERS

Quick-drying markers with low odour, non-toxic ink provide bold colours. Easily wipes off. Chisel tip.

ORDER NUMBER	DESCRIPTION	UNIT
1 27811-50040	Black	10/BX
2 27811-50041	Assorted	4/PK



B ELMER'S® BOARDMATE® CHALK MARKERS

Looks like chalk... without the dust! Acts like a marker, with bullet tip. Erase easily with a damp cloth. Washable, odorless, safe & non-toxic.

ORDER NUMBER	DESCRIPTION	UNIT
E152M	White, orange, pink, blue	4/PK

D CRAYOLA® SIDEWALK CHALK

Square. Assorted colours.

ORDER NUMBER	UNIT
51-3555	12/BX



F DUDLEY® COMBINATION LOCKS

Three-digit combination; hardened steel shackle provides extra cut resistance. School standard lock since 1922.



ORDER NUMBER	DESCRIPTION	UNIT
1 DYRP7SP	Standard combination lock	EA
2 DYRP3SP	Serialized for extra security	EA



H MERANGUE® CHAIR SLIPPERS

Reduces noise. Helps prevent injury from falls. Helps prevent floor scuffs and scrapes. Ideal for schools, day cares, seniors and rehab centers.

ORDER NUMBER	DESCRIPTION	UNIT
1026-5082-00-000	Assorted	4/PK



A DAVIS GROUP™ QUICKFIT® EDUCATIONAL DRY-ERASE POCKETS

Reduce paper waste – teachers can reuse worksheets. Durable heavyweight construction. Convenient grommet hole allows pockets to easily hang inside classroom. Wipes clean with a soft, dry cloth or tissue. 9"×12", assorted colours.

ORDER NUMBER	DESCRIPTION	UNIT
1 40105		5/PK
2 40110-DAV		10/PK
3 40125		25/PK

C ZIPLOC® BIG BAGS

Features a pleated bottom, a secure double zipper seal and built-in handles. Creates ideal storage solutions for almost anything. 15"×15" (38cm x 38cm).



ORDER NUMBER	DESCRIPTION	UNIT
67140-70293		5/BX



F TREND® DESK TOPPERS® NAME PLATES

Brighten your classroom with versatile name plates that make each child feel important! Perfect for labeling everything from lockers to storage, and creating reminders, announcements & schedules. Includes guidelines for printing/writing practice. 27/8"×9½".

ORDER NUMBER	DESCRIPTION	UNIT
1 T69013	Colourful Crayons	36/PK
2 T69217	Owl-Stars!®	36/PK
3 T69235	Sock Monkeys	36/PK

B VELCRO® FASTENERS

Self-adhesive white hook and loop fasteners.



ORDER NUMBER	DESCRIPTION	UNIT
1 90070	5/8" circles, 15 sets per pack	PK
2 90073	7/8" squares, 12 sets per pack	PK
3 90076	¾"×3½" strips, 4 sets per pack	PK
4 90082	¾"×15' tape	EA

D LEPAGE® FUNTAK®

Adhesive putty that won't dry out; non-toxic, non-flammable and repositionable. Mount posters or photographs without using pins.

ORDER NUMBER	DESCRIPTION	UNIT
61083-05401	56 g	CD



E ELMER'S® TAC 'N STIK® ADHESIVE PUTTY

Removable adhesive putty that replaces tapes and tacks. Ideal for holding posters, messages, displaying decorations on windows and more. Reusable and won't dry out. Non-toxic and acid-free. 84 g.

ORDER NUMBER	DESCRIPTION	UNIT
61550-06531		PK

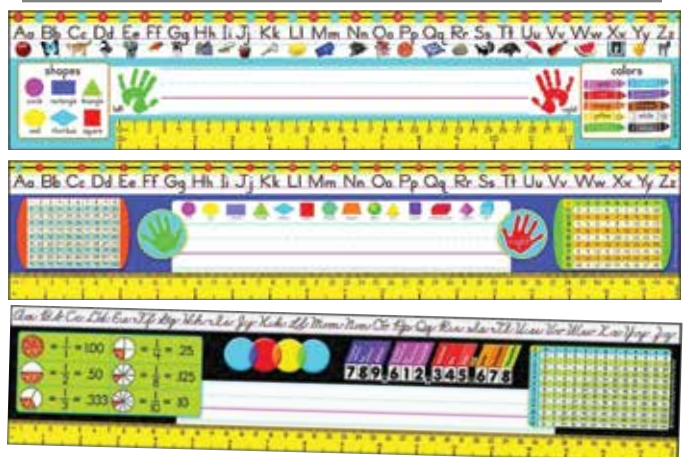

G TREND® DESK TOPPERS® REFERENCE NAME PLATES

Put a world of facts at children's fingertips. These grade-appropriate name plates feature language arts and math facts. 3¾"×18".

ORDER NUMBER	DESCRIPTION	UNIT
1 T69401	PreK - 1	36/PK
2 T69402	Grades 2-3	36/PK
3 T69403	Grades 3-5	36/PK

Education – classroom essentials



A TREND® TERRIFIC TRIMMERS®

Layer patterns on solids, sparkles, or metallics to engage & delight. Use as-is to showcase student work, make crowns, bookmarks and more. The perfect touch for whiteboards, reward charts, calendars or any display. Durable & reusable.

ORDER NUMBER	DESCRIPTION	UNIT	ORDER NUMBER	DESCRIPTION	UNIT	ORDER NUMBER	DESCRIPTION	UNIT
2¼"×39'			2¼"×32½'					
1	T92682 I ♥ Metal™ Silver Stars	PK	6	T92044 Rainbow Plaid	PK	10	T91408 Silver Sparkle	PK
2	T91352 World Flags	PK	7	T92045 Rainy Day Boots	PK	11	T91410 Red Sparkle	PK
3	T91400 Math Fun	PK	8	T92132 Fall Fun	PK	12	T91412 Yellow Sparkle	PK
4	T91406 Winter Fun	PK	9	T92138 Rainbow Gel	PK	13	T91413 Blue Sparkle	PK
5	T92002 Helping Hands	PK						



B TREND® FOUR SEASONS TERRIFIC TRIMMERS® VARIETY PACK

Durable and reusable. Four designs, 39 feet each for a total of 156 feet.

ORDER NUMBER	UNIT
T92914	PK



C TREND® BOLDER BORDERS®

Create show stopping displays, morning message boards and daily schedules that capture attention, add energy & excitement. Precut, durable, reusable. 2¾"×35¾".

ORDER NUMBER	DESCRIPTION	UNIT
1	T85100 Sock Monkeys	PK
2	T85130 Sea Buddies™	PK



D TREND® TERRIFIC LABELS™

Bright, welcoming labels are designed for no-smear writing with markers or pens. Perfect for name tags: labels stay put and won't leave residue on clothes. Great for cubbies, lockers, storage boxes, envelopes, learning centers, and much more. Self-adhesive. 2½"×3".

ORDER NUMBER	DESCRIPTION	UNIT
1	T68005 Rainbow Handprints	36/PK
2	T68125 I ♥ Metal™ Dots	36/PK
3	T68117 Owl-Stars!®	36/PK

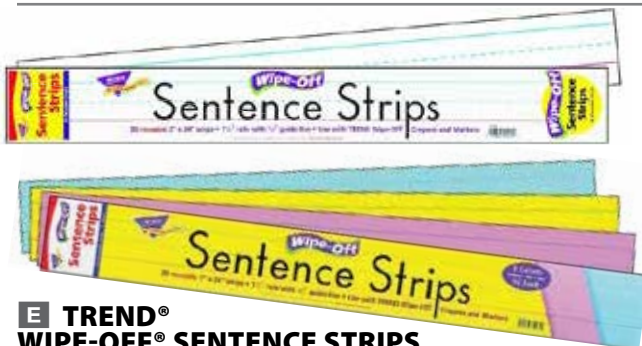

E TREND® WIPE-OFF® SENTENCE STRIPS

Give kids a chance to practice again and again. Class-size packs. 24"×3".

ORDER NUMBER	DESCRIPTION	UNIT
1	T4001 White	30/PK
2	T4002 Tricolour	30/PK

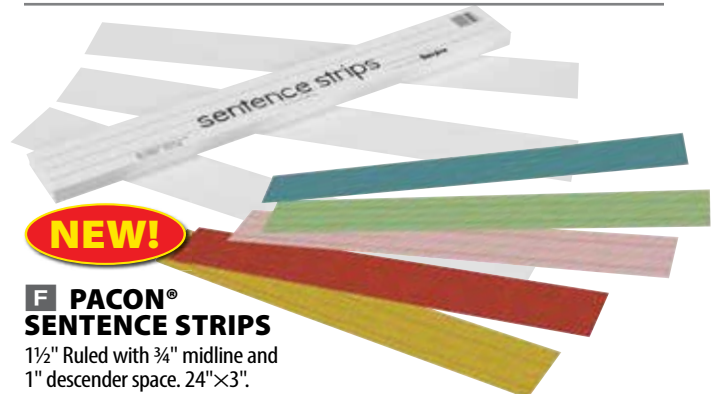

F PACON® SENTENCE STRIPS

1½" Ruled with ¾" midline and 1" descender space. 24"×3".

ORDER NUMBER	DESCRIPTION	UNIT
1	P5166 White	100/PK
2	P0073400 Assorted colours	100/PK



A TREND® COLOURFUL CLASSICS CERTIFICATES

Mark achievement throughout the year for students, volunteers and staff. Dynamic designs and positive messages. Printer compatible, ready to frame. 8½"×11".

ORDER NUMBER	DESCRIPTION	UNIT
1 T2959	Honor Roll Award	30/PK
2 T2960	Student of the Week	30/PK
2 T2954	Congratulations	30/PK
2 T2965	Recognition	30/PK



B TREND® PK-K CERTIFICATES & DIPLOMAS

Celebrate early learning! Recognize children's first school experiences and give a feeling of success. Charming designs and messages celebrate participation and completion. Printer compatible and ready to frame. 8½"×11".

ORDER NUMBER	DESCRIPTION	UNIT
1 T17002	Classic Kindergarten Diploma	30/PK
2 T17005	Kindergarten Diploma	30/PK
3 T17006	Preschool Certificate	30/PK
4 T17009	Kindergarten Certificate Owl-Stars!®	30/PK



C TREND® RECOGNITION AWARDS

Celebrate special moments with awards kids are proud to take home. They are easy to customize with personal messages, notes, and praise. 5½"×8½".

ORDER NUMBER	DESCRIPTION	UNIT
1 T81017	Happy Birthday Cake	30/PK
2 T81019	I'm a Star Student	30/PK
3 T81044	Happy Birthday Owl-Stars!®	30/PK
4 T81047	Way to Go! You Shine!	30/PK
5 T8107	Star of the Week!	30/PK

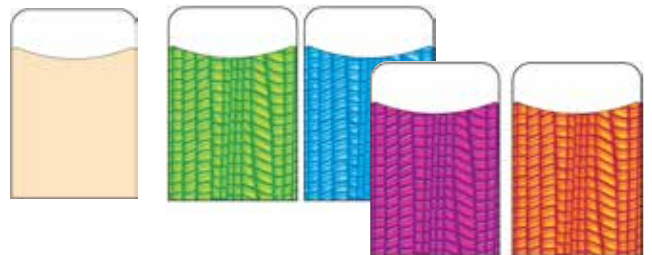

D TREND® LIBRARY POCKETS

Library pockets are easy to load for storage and displays. Use handy pockets in planners and notebooks, organize your classroom library, and display flash cards, prizes, or bookmarks on bulletin boards. Acid free. 3½"×5¼"

ORDER NUMBER	DESCRIPTION	UNIT
1 T77303	Vanilla Terrific™ Pockets™ NEW!	40/PK
2 T77907	Reptile Terrific Pockets™	40/PK

E TREND® SPARKLE STICKERS®

Little sparklers are a big hit with kids! Just the right size to put on homework and reward good behaviour. Acid-free, non-toxic, and safe for use on photos.

ORDER NUMBER	DESCRIPTION	UNIT
1 T6300	Apple Dazzlers	72/PK
2 T63007	Party Pumpkins	72/PK

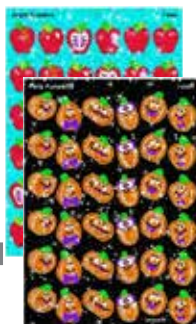

F WESTCOTT® STARS STICKERS

Just peel and stick. Use to mark work or to encourage good behavior or use as a great craft item.

ORDER NUMBER	DESCRIPTION	UNIT
1 65956-01344	Red	350/PK
2 65956-01324	Blue	350/PK
3 65956-01394	Silver	350/PK
4 65956-01354	Gold	350/PK
5 65956-11270	Assorted colours	350/PK





A TREND® STICKER PADS

Surprise students every time! Acid-free, non-toxic, safe for photos. 5¾"×9½" pad.

ORDER NUMBER	DESCRIPTION	UNIT
1 T5006	Seasons And Holidays	738/PK
2 T5009	Animal Antics	738/PK
3 T5010	Super Stars And Smiles	738/PK
4 T5011	Praise & Reward	738/PK
5 T5008 NEW!	Schootime Fun	738/PK
6 T5005 NEW!	Sparkly Stars, Hearts & Smiles	336/PK

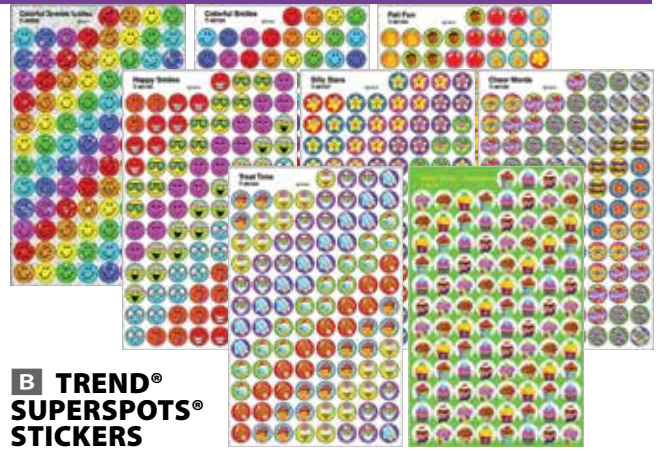

B TREND® SUPERSPOTS® STICKERS

Dynamic spots encourage and delight! Perfect for tracking progress and spotlighting success. Acid-free, non-toxic, and safe for use on photos.

ORDER NUMBER	DESCRIPTION	UNIT
1 T46505	Colourful Sparkle Smiles	400/PK
2 T46134	Colourful Smiles	800/PK
3 T46153	Fall Fun	800/PK
4 T46155	Happy Smiles	800/PK
5 T46157	Silly Stars	800/PK
6 T46159	Cheer Words	800/PK
7 T46164	Treat Time	800/PK
8 T46189	The Bake Shop™ Cupcakes	800/PK



C TREND® SUPERSHAPES STICKERS

Light up faces with popular little stickers in fun shapes! Acid-free, non-toxic, and safe for photos.

ORDER NUMBER	DESCRIPTION	UNIT
1 T46304	Construction Vehicles, large	200/PK
2 T46074	Sports Balls	800/PK
3 T46327	The Bake Shop™ Cupcakes	200/PK
4 T46037	Alphabet	800/PK
5 T46908	Alphabet, Numbers & Shapes Variety Pack	2500/PK
6 T46301	Rescue Vehicles, large	208/PK
7 T46039	Weather	800/PK
8 T46606	Colourful Foil Stars	400/PK
9 T46405	Colourful Sparkle Stars	400/PK
10 T46075	Happy Apples	800/PK
11 T46058	Zoo Animals	800/PK
12 T46080	Heart Smiles	800/PK
13 T46079	Star Smiles	800/PK
14 T46036	Numbers	800/PK



D TREND® STINKY STICKERS®

Everyone's favorite stickers! Fun to collect & trade, provide encouragement, and celebrate success. Acid-free, non-toxic, and safe for use on photos. 3 designs.

ORDER NUMBER	DESCRIPTION	UNIT
1 T6407	Earth & Space (Grape scent)	60/PK
2 T6411	Lots Of Chocolate (Chocolate scent)	60/PK
3 T6418	School Time (Apple scent)	60/PK
4 T83403	Thanksgiving (Pumpkin scent)	60/PK
5 T928	Valentine's Day (Cherry scent)	60/PK
6 T930	Halloween (Licorice scent)	60/PK
7 T932	Christmas (Peppermint scent)	60/PK

E TREND® SUPERSPOTS® AND SUPERSHAPES VARIETY PACKS

Handy favorites in a mega pack! superSpots® and superShapes provide extra value in every pack. Add cheer to rewards, homework, and more.



ORDER NUMBER	DESCRIPTION	UNIT
1 T46916	Everyday Favourites Variety Pack	2500/PK
2 T46826 NEW!	Awesome Assortment	5100/PK

Cleaning, Breakroom & Facilities

Adhesives & Tape	495-496
Air Care	447-452
Breakroom Supplies	403-419
Brooms, Mops & Dusters	439-446
Cleaning Supplies	420-432
Fans & Heaters	476-477
First Aid	459-466
Hand Soap & Sanitizer.	453-458
Key Control.	497
Knives	493-494
Ladders & Trucks	499-501
Laundry	438
Lockers.	505
Locks	498
Mats.	478-479
Mirrors & Crowd Control	504
Outdoor Supplies	486-488
Paper Towels & Tissue	433-437
Safety Supplies.	467-475
Shelving.	502-503
Shipping Supplies.	506-514
Tools.	489-492
Waste.	480-485





DON'T UNDERESTIMATE THE POWER OF A GREAT OFFICE COFFEE

Coffee—caffeinated goodness that can make or break an employee's day. And, great coffee is a valuable office perk that shows you care about your staff's well-being.

That's why we're proud to offer revolutionary brewing technologies along with an incredibly wide variety of K-Cup® blends and brands to please discerning palates.

Furthermore, now that all our pods in Canada are recyclable, we've also introduced K-Cycle™, a simple, commercial program aimed at helping companies consolidate pods for easy recycling.

At Keurig®, we create the ultimate beverage experience in every life we touch from source to cup.



 **Keurig
DrPepper**™/MC

Breakroom Supplies – single serve brewers



A KEURIG® K-3500™ COMMERCIAL COFFEE MAKER

Ideal for the busy breakroom, this brewer is engineered for continuous use and back to back brewing. Features 5 cup sizes including the new 12 ounce size, strong brew and an intuitive touch-screen. It also has a dedicated hot water line. Direct water line plumbing. 12"W×18"D×17.4"H. 35lbs.

ORDER NUMBER	UNIT
50-37955	EA



B KEURIG® K2500 COMMERCIAL BREWER

Ideal for busy breakrooms.

When plumbed, can brew continuously, or use with 3.25 L reservoir (sold separately). Five brew sizes: 4, 6, 8, 10 and 12-ounce cups. Strong brew option and an intuitive touch screen. 7.87"W (12"W with Reservoir)×14¼"D×13"H. 15lbs.

ORDER NUMBER	DESCRIPTION	UNIT
1 50-37952	Brewer	EA
2 76-38571	Reservoir	EA



C KEURIG® K155 BREWER FOR SMALL TO MEDIUM OFFICES

Interactive touchscreen. Fully programmable. Set to English, French or Spanish. Choose from 4 oz., 6 oz., 8 oz., 10 oz., or 12 oz. Reservoir holds up to 90 oz. May be direct-water-line plumbing compatible with optional accessory. Commercial grade - engineered for continuous use. 10¾"W×14"D×13¾"H. 18 lbs.

ORDER NUMBER	UNIT
75-36888	EA



D KEURIG® K1500 SMALL BUSINESS BREWER

Minimize noise during use with Quiet Brew Technology™. Large 96 oz reservoir with 12 oz brew size. Strong brew selection for bolder, more intense flavor. Black and Silver.

ORDER NUMBER	UNIT
50-38114	EA



E ONEBREW® K-CUP CAROUSEL STORAGE

Storage carousel for coffee pods. Full 360° rotation.

ORDER NUMBER	DESCRIPTION	UNIT
1 25MI370	Holds 18 pods	EA
2 25MI371	Holds 36 pods	EA



F TANNEX® STORAGE DRAWER

Store your favourite coffee capsules such as K-Cups or other kitchen items discreetly with a matte black undercabinet storage drawer. Includes railings and screws. Holds 48 K-Cups. 26"×9"×2".

ORDER NUMBER	UNIT
25MI383-L48CT	EA

G KEURIG® DESCALING SOLUTION

The only solution approved for cleaning Keurig® brewing systems. Clean quarterly to extend brewer life. Compatible with K-Mini®, K-Duo® Essentials, K-Select®, K-Mini Plus®, K-Elite™, K-Compact®, K-Cafe®, K-Duo®, K-Cafe® Special Edition, and K-Duo® Plus. Removes mineral build-up, fast-acting and odourless. 400 mL.



ORDER NUMBER	UNIT
60-40580	EA

Due to safety concerns, edible items are non-returnable.
Check online for the most current price.

Breakroom Supplies – single serve coffee



A MCCAFÉ® PREMIUM ROAST COFFEE K-CUPS®PODS

ORDER NUMBER	DESCRIPTION	UNIT
1 61-60832	Medium Dark Roast	24/BX
2 11KR180	Medium Dark Roast	30/BX
3 11KR181	Decaffeinated Medium Dark Roast	12/BX



B STARBUCKS® COFFEE K-CUPS

24/box.

ORDER NUMBER	DESCRIPTION	UNIT
1 74-09076	Caffé Verona® Dark Roast	BX
2 93-20068	True North Blend	BX
3 74-09072	Pike Place® Medium Roast	BX
4 74-09073	Decaf Pike Place® Medium Roast	BX
5 74-09037	French Roast	BX



C TIMOTHY'S® SPECIALTY COFFEE K-CUPS

24/box.

ORDER NUMBER	DESCRIPTION	UNIT
1 96-06771	Breakfast Blend Light Roast	BX
2 96-06776	Colombian Excelencia Medium Roast	BX
3 96-06775	Colombian Medium Roast Decaffeinated	BX
4 96-06782	Donut Blend Light Roast	BX
5 77-06017	French Vanilla Latte	BX
6 96-06784	Hazelnut Medium Roast	BX
7 96-06792	Italian Blend Medium Roast	BX
8 96-06785	Midnight Magic Extra Bold Dark Roast	BX
9 96-06766	Rainforest Espresso® Extra Bold Dark Roast	BX



D THE ORIGINAL DONUT SHOP® COFFEE K-CUPS

24/box.

ORDER NUMBER	DESCRIPTION	UNIT
56-07722	Medium Roast	BX



F VAN HOUTTE® COFFEE K-CUPS

24/box.

ORDER NUMBER	DESCRIPTION	UNIT
1 40-19917	Breakfast Blend Light Roast	BX
2 40-53917	French Vanilla Light Roast	BX
3 40-33918	Colombian Medium Roast	BX
4 40-59918	Original House Blend	BX
5 80-51517	Mexico Fair Trade Organic Dark Roast	BX
6 80-01017	Amazonia Fair Trade Medium Roast	BX
7 80-97917	Costa Rica Fair Trade Light Roast	BX
8 80-07712	Honduras Extra Bold Medium Roast	BX
9 80-89817	Sumatra Fair Trade Extra Bold Dark Roast	BX
10 40-39917	Vanilla Hazelnut Light Roast	BX
11 40-54917	Original House Blend Decaf	BX



E KAHLÚA® COFFEE K-CUPS

24/box.

ORDER NUMBER	DESCRIPTION	UNIT
97-01341	Kahlúa Original® Medium Roast	BX

CLEANING, BREAKROOM AND FACILITIES

Breakroom Supplies – single serve coffee coffee



A TIM HORTONS® COFFEE K-CUPS

24/box.

ORDER NUMBER	DESCRIPTION	UNIT
1 61-01306	Original Blend	BX
2 61-01307	Dark Roast	BX
3 61-01308	Decaf	BX
4 61-11309	100% Colombian	BX
5 61-11311	French Vanilla	BX



B GREEN MOUNTAIN COFFEE® K-CUPS

24/box.

ORDER NUMBER	DESCRIPTION	UNIT
1 94-06800	Caramel Vanilla Cream Light Roast	BX
2 94-04761	Dark Magic® Extra Bold Dark Roast	BX
3 94-06799	Half-Caff Medium Roast	BX
4 94-60859	Island Coconut™ Light Roast	BX
5 94-07832	Decaf French Vanilla Light Roast	BX



C ADAGIO CAFFÈ NAPOLI K-CUPS

24/box.

ORDER NUMBER	DESCRIPTION	UNIT
1 86-26924	House Blend Medium Roast	BX
2 86-28924	House Blend Decaf Medium Roast	BX
3 86-27924	Caffè Napoli Dark Roast	BX

NEW!
NEW!



D DONUT HOUSE COLLECTION® K-CUPS

24/box.

ORDER NUMBER	DESCRIPTION	UNIT
94-06834	Donut House® Light Roast	BX



E FOLGERS COFFEE K-CUPS

24/box.

ORDER NUMBER	DESCRIPTION	UNIT
1 61-22711	Caramel Drizzle Medium Roast	BX
2 61-20902	Classic Medium Roast	BX
3 61-22709	Lively Colombian Medium Roast	BX
4 61-22714	Vanilla Biscotti Medium Roast	BX
5 61-20905	Black Silk Dark Roast	BX

NEW!

NEW!



F BARISTA PRIMA COFFEEHOUSE® K-CUPS

24/box.

ORDER NUMBER	DESCRIPTION	UNIT
89-60863	Italian Dark Roast	BX



H TASSIMO T DISCS

ORDER NUMBER	DESCRIPTION	UNIT
NABOB COFFEE PODS		
1 11KR152	Nabob Breakfast	14/BX
2 11KR158	Nabob French Vanilla	14/BX
MCCAFÉ® COFFEE PODS		
3 11KR176	McCafé Premium Roast	14/BX
MAXWELL HOUSE COFFEE PODS		
4 11KR153	Maxwell House Blend	16/BX



G EMERIL'S® COFFEE K-CUPS

24/box.

ORDER NUMBER	DESCRIPTION	UNIT
97-01936	Big Easy® Bold Dark Roast	BX

Due to safety concerns, edible items are non-returnable.
Check online for the most current price.

CLEANING, BREAKROOM
AND FACILITIES

Breakroom Supplies – hot chocolate and tea



A TIM HORTONS® HOT CHOCOLATE K-CUPS

20/box.

ORDER NUMBER	DESCRIPTION	UNIT
61-12573	Hot Chocolate mix	BX



B LAURA SECORD® K-CUPS

24/box.

ORDER NUMBER	DESCRIPTION	UNIT
77-21917	Hot Chocolate Mix	BX



C TIM HORTONS® TEA K-CUPS

30/box.

ORDER NUMBER	DESCRIPTION	UNIT
15MI189	Orange Pekoe Black Tea	BX



D CARNATION HOT CHOCOLATE

Canada's #1 hot chocolate brand since 1973. Perfect blend of chocolate, milk and sweetness. Rich and creamy. Just add 175ml of water

ORDER NUMBER	DESCRIPTION	UNIT
55000-38310	25g	50/BX



E TIMOTHY'S® SPECIALTY TEA K-CUPS

24/box.

ORDER NUMBER	DESCRIPTION	UNIT
77-10517	Chai Tea Latte	BX



F TETLEY® TEA K-CUPS

24/box.

ORDER NUMBER	DESCRIPTION	UNIT
1 81-12817	Pure Peppermint Tea	BX
2 81-17817	Green Tea	BX
3 81-06817	Orange Pekoe	BX
4 81-60869	Earl Grey	BX



G MOTHER PARKERS 4 STAR ORANGE PEKOE TEA

A blend of leaves from Ceylon, Kenya and Indonesia. 100 bags/box.

ORDER NUMBER	UNIT
15MP120	BX



H TETLEY® TEA

Since 1837, the experts at Tetley have painstakingly chosen and carefully blended leaves from around the world to give you the delicious taste of Tetley. Orange Pekoe. 100 bags/box.

ORDER NUMBER	UNIT
15TE102	BX

Breakroom Supplies – tea



A TETLEY® TEAS

Since 1837, the experts at Tetley have painstakingly chosen and carefully blended leaves from around the world to give you the delicious taste of Tetley. 25/box.

ORDER NUMBER	DESCRIPTION	UNIT
1 15TE130-ENGBRKF25CT	Black Tea, English Breakfast	BX
2 15TE130-EARLGR25CT	Black Tea, Earl Grey	BX
3 15TE130-CHAI25CT	Black Tea, Chai	BX
4 15TE130-DCFORGPK25CT	Decaffeinated Black Tea, Orange Pekoe	BX
5 15TE130-PUREGRN25CT	Green Tea, Pure Green	BX
6 15TE130-CHAM25CT	Herbal Tea, Pure Camomile	BX
7 15TE130-PURP/MNT25CT	Herbal Tea, Peppermint	BX
8 15TE130-WLDBRY25CT	Herbal Tea, Wildberries	BX

C LIPTON® TEA

100 bags/box.

ORDER NUMBER	DESCRIPTION	UNIT
1 15LI141	Black Tea	BX
2 15LI118	Green Tea, Herbal	BX



B HIGGINS & BURKE™ SPECIALTY TEAS

Premium quality, hand picked estate leaves for rich anti-oxidant content and bold flavour. 20 bags/box.

ORDER NUMBER	DESCRIPTION	UNIT
1 15MP104-ENGBR20S	Black Tea, English Breakfast	BX
2 15MP104-LEMON20S	Black Tea, Lemon	BX
3 15MP104-EARLGR20S	Black Tea, Earl Grey	BX
4 15MP104-GRTEA20S	Green Tea, Herbal	BX
5 15MP104-PEPMINT20S	Herbal Tea, Peppermint	BX



D HIGGINS & BURKE TEA K-CUPS

Real loose leaf tea in a single serve format. 24/box.

ORDER NUMBER	DESCRIPTION	UNIT
NEW! 1 15MP119	Black Tea, Orange Pekoe	BX
2 15MP121-ROARING24CT	Black Tea, Roaring Black	BX
3 15MP121-BERGGREY24CT	Black Tea, Bergamia Grey	BX
4 15MP121-KAZCHAI24CT	Black Tea, Chai Glow	BX
5 15MP121-TAMEDRAG24CT	Bountiful Green	BX
6 15MP121-CHAMMOON24CT	Caffeine-free Herbal, Chamomile Meadows	BX
7 15MP121-LUSHBRY24CT	Caffeine-free Herbal, Lush Berry	BX



E TAZO® TEAS

Full-flavoured, herbal teas are individually wrapped for convenience and perfect for individual consumption. Tazo is life, rebled. 20 bags/box.

ORDER NUMBER	DESCRIPTION	UNIT
1 15LI143-ZEN20CT	Zen	BX
2 15LI143-EARLGR20CT	Earl Grey	BX
3 15LI143-AWAKE20CT	Awake	BX
4 15LI143-ORGCHAI20CT	Organic Chai	BX
5 15LI143-CALMCHAM20CT	Calm Chamomile	BX

CLEANING, BREAKROOM AND FACILITIES

Due to safety concerns, edible items are non-returnable.
Check online for the most current price.

Breakroom Supplies – coffee makers and kettles

A BUNN® 12-CUP POUR-O-MATIC COFFEE BREWER

Stainless steel hood and base. No plumbing needed. Two separately switched warming stations with indicator lights. Includes plastic pitcher and 50 filters. Decanters are sold separately. Brewing capacity: 100 cups per hour. UL listed for commercial and institutional use



ORDER NUMBER	UNIT
33200.6000	EA

B BUNN® BREWER ACCESSORIES

For use with most 12 cup coffee brewers.



ORDER NUMBER	DESCRIPTION	UNIT
EASY POUR COFFEE DECANTER - HOLD 12 CUPS		
1 06100.0201	Regular black handle	EA
FILTERS - TWO PACKS OF 500/BX		
2 20115.6000	4½"W×2½"H	BX

C HAMILTON BEACH® 12-CUP COFFEE BREWER

Easy to read programmable LCD clock with 2-hour worry-free automatic shut off. Auto pause and serve. Dishwasher safe carafe. Black.



ORDER NUMBER	UNIT
43874	EA

D BUNN® THERMAL SERVER

An appealing, easy to use, easy to transport, self service coffee system. Convenient for keeping coffee hot and fresh for hours. Standard base accommodates up to 4½" tall cups. Removable drip tray holds 2.5 oz. Sturdy handle with built in name tag holder. Mesh filter included in brew through lid. 7½"W×8½"D×17¼"H. Black.



ORDER NUMBER	DESCRIPTION	UNIT
23300.6101	2.5L	EA

E HAMILTON BEACH® 45-CUP COFFEE URN

One-cup-per-minute brewing speed. Features a dishwasher safe permanent filter basket and lid, easy to read interior fill level markings, and a safety anti-boil dry shutoff. Silver and Black.



ORDER NUMBER	UNIT
40515CR	EA

F MOTHER PARKERS COFFEE FILTERS

Paper basket coffee filters for 12-cup coffee maker. 500 per package. 2 packages/box.



ORDER NUMBER	UNIT
1708501	BX

G BLACK & DECKER® CORDLESS STAINLESS STEEL KETTLE

1500 Watts, 360°swivel base for easy handling. Features auto shut-off with on/off power indicator, one touch, stay-open hinged lid, water level indicator, anti-scale filter and boil-dry protection. Cord wraps safely under unit for storage. 1.7 L. 2-year limited warranty. Brushed stainless steel.



ORDER NUMBER	UNIT
KE1518SD	EA

Breakroom Supplies – coffee



A MOTHER PARKERS COFFEE

A good blend of coffee from Central America, this coffee delivers satisfaction and value. Freshness sealed and consistent in taste. 925 g.

ORDER NUMBER	UNIT
11MP225	EA



B TIM HORTONS® PREMIUM FINE GROUND COFFEE

The signature flavour in every cup created using a blend of 100% Arabica beans. 930 g.

ORDER NUMBER	UNIT
11GR175	EA



C MCCAFFÉ® PREMIUM ROAST FINE GROUND COFFEE

Made from 100% Arabica beans. Resealable tin. 950 g.

ORDER NUMBER	UNIT
11KR192	EA



D DISTINCTIVELY YOURS GROUND COFFEE FROM MOTHER PARKERS

Good, Central American coffee blend delivering satisfaction and value. Freshness sealed. Consistent taste.

ORDER NUMBER	DESCRIPTION	UNIT
1 11MP174	Mountain Grown, 39 g	42/BX
2 11MP231	Classic Roast, 42.5 g	64/BX



E TIMOTHY'S GROUND COFFEE

Timothy's selects only the top 1-5% of Arabica beans from coffee growing regions around the world. They are Specialty grade – the highest grade possible. 70.8 g.

ORDER NUMBER	DESCRIPTION	UNIT
1 74-02014	Breakfast Blend	24/BX
2 74-02015	Colombian La Vereda	24/BX
3 74-02017	Italian Blend	24/BX
4 74-02021	Decaf Colombian	24/BX



F TASTER'S CHOICE INSTANT COFFEE

House Blend. 100% pure coffee without the cost and preparation hassle. 1.7g stick packs.

ORDER NUMBER	DESCRIPTION	UNIT
1 28000-15782	Original	80/BX
2 28000-66488	Decaf	80/BX



G MOTHER PARKERS GROUND COFFEE

Good, Central American coffee blend delivering satisfaction & value. Freshness sealed. Consistent taste.

ORDER NUMBER	DESCRIPTION	UNIT
1 11MP101-42X1.75	100% Colombian, 49 g	42/BX
2 11MP168	Café Blend, 71 g	64/BX
3 11MP109-64x2.5	Exclusive Blend, 71 g	64/BX

CLEANING, BREAKROOM AND FACILITIES

NEW!

Due to safety concerns, edible items are non-returnable.
Check online for the most current price.

Breakroom Supplies – cream, sugar and sweeteners



A GRAND PRÉ™ MILK

Can be kept up to 9 months without refrigeration and 20 days in the refrigerator after opening. 2% 1 L.

ORDER NUMBER	UNIT
22MI115	EA



B NESTLÉ® COFFEE MATE®

Blends quickly & completely. Delicious in hot and cold beverages. 9 month shelf life without refrigeration. 11ml.

ORDER NUMBER	DESCRIPTION	UNIT
1 50000-46130	Original	180/CT
2 50000-46240	French Vanilla	180/CT
3 50000-46350	Hazelnut	180/CT

C NESTLÉ® COFFEE MATE® ORIGINAL WHITENER



ORDER NUMBER	DESCRIPTION	UNIT
50000-63040	311 g	EA



D REDPATH® SUGAR

Pure cane sugar.

ORDER NUMBER	DESCRIPTION	UNIT
1 18MI102	3.5 g packets	1000/BX
2 18MI100	2 kg bag	EA



E BEEMAID PURE LIQUID HONEY

100% pure Canadian honey. 500 g.

ORDER NUMBER	UNIT
17MI161	EA



F DURE SUGAR & WHITENER

ORDER NUMBER	DESCRIPTION	UNIT
1 18DU101	Sugar shaker, 570 g	EA
2 18DU100	Whitener, 340 g	EA



G REDPATH® SUGAR CUBES

Natural, real sugar. 15 Calories per teaspoon. 500 g.

ORDER NUMBER	UNIT
18MI168	BX



H SWEET'N LOW SWEETENER

0.8g packets.

ORDER NUMBER	UNIT
18MI188	200/BX



I SPLENDA® SWEETENER

1g packets

ORDER NUMBER	UNIT
18MI118	100/BX

J SUGAR IN THE RAW® NATURAL TURBINADO SUGAR

Enjoy sweet moments with Turbinado sugar grown in the tropics. Golden crystals are never bleached, keeping their flavor and colour of their natural molasses. 500 g.

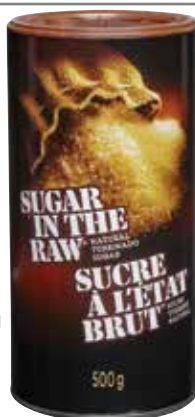

ORDER NUMBER	UNIT
18KR101	EA



K REDPATH® TURBINADO SINGLE SERVE SUGAR

Made from golden turbinado sugar which is boiled directly from natural concentrated cane juices. Distinctive large crystals and mild molasses flavour. 3.5 g, 1,000/box.

ORDER NUMBER	UNIT
18MI103	BX



NEW!

L PLANTATION BROWN SUGAR PACKETS

3.5 g. packets.

ORDER NUMBER	UNIT
02061	1000/CT

CLEANING, BREAKROOM AND FACILITIES

COMPOSTABLE
REDUCE OUR FOOTPRINT

NEW!

A COMPOSTABLES BY GLOBE™ SINGLE WALL HOT/COLD CUPS

100% compostable cups made from sugarcane fibre. The cups are lined with PLA which is a renewable bio-resin made from corn. As a liner, it resists leaking and is used instead of the typical petroleum-based cup lining. These non-toxic, classic hot coffee cups are the best on the market making them ideal for serving coffee, tea, and other steamy beverages. Lids are completely bio-based and compostable too.



ORDER NUMBER	DESCRIPTION	UNIT
1 6052	8 oz. cup	50/PK
2 6054	12 oz. cup	50/PK
3 6055	16 oz. cup	50/PK
4 6056	20 oz. cup	50/PK
5 6081	Lids	50/PK

COMPOSTABLE
REDUCE OUR FOOTPRINT



B SOLO® BARE® PAPER HOT CUPS

PLA lined cups are compostable in commercial compost facilities. Rolled rim for secure fit. Use with lid #6081.

ORDER NUMBER	DESCRIPTION	UNIT
412PLN-JT330	12 oz	50/PK



C HY PAX RIPPLE CUPS AND LIDS

Ripple design makes the cup cool to the touch. No need for sleeves or double cups. Microwavable. Brown. Use with lid #6081.

ORDER NUMBER	DESCRIPTION	UNIT
1 HPE-HC12RK	12 oz	40/PK
2 HPE-HC16RK	16 oz	20/PK

D FROST CUP DISPENSER

Water cup dispenser. Holds 200 cups. Includes mounting hardware.

ORDER NUMBER	UNIT
1 185	EA
DART CONE WATER CUPS	
Treated paper cup with rolled rim. Designed for cold applications. 4 oz.	
2 4BR-2050	200/PK



E STIR STICKS

ORDER NUMBER	DESCRIPTION	UNIT
80411N	Wood, 5½"	1000/BX

Due to safety concerns, edible items are non-returnable.
Check online for the most current price.

Breakroom Supplies – tableware



✓ **COMPOSTABLE**
REDUCE OUR FOOTPRINT

NEW!

A COMPOSTABLES BY GLOBE™

The bagasse plates, bowls and hinged containers are made of 100% sugarcane fiber, a sustainable, renewable, and biodegradable material. Sugarcane pulp is hygienic and green and 100% biodegradable in 90-180 days. Leak free, sturdy, stackable and engineered for heavy duty use. Meets ASTM D6400 and/or D6868 for Compostability. Other sizes available.

ORDER NUMBER	DESCRIPTION	UNIT
6020	6" Plates	50/PK
6022	9" Plates	50/PK
6041	16 oz. Bowls	50/PK
6011	8"x8"x3" Hinged container	50/PK

✓ **COMPOSTABLE**
REDUCE OUR FOOTPRINT



B ROYAL CHINET PAPER PLATES

Canadian made. Compostable.

ORDER NUMBER	DESCRIPTION	UNIT
10124	8" dinner plate	40/PK

✓ **COMPOSTABLE**
REDUCE OUR FOOTPRINT



NEW!

C COMPOSTABLES BY GLOBE™ TAKEOUT CONTAINER

Ideal alternative to traditional plastic or foam containers that performs like plastic and composts like a piece of fruit. Leak and cut resistant. #8. Other sizes available.

ORDER NUMBER	DESCRIPTION	UNIT
6064	6"Lx4.75"Wx2.5"H	50/PK



D SALT AND PEPPER PACKETS

Single serving; 1000 per box.

ORDER NUMBER	DESCRIPTION	UNIT
1 25MI122	Salt	BG
2 25MI126	Pepper	BG



E GLOBE™ PITCHER

Commercial grade polycarbonate resists breaking and chipping. Lightweight for easy transportation. NSF Approved. BPA Free. Drip-proof spout for the perfect pour. Clear. 60 oz.

ORDER NUMBER	UNIT
1200	PK

NEW!



F NALGENE® ON-THE-FLY SUSTAINABLE WATER BOTTLES

Leak proof, lock-top opens easily for convenient one hand refreshment on the fly. Made with 50% recycled content, each bottle is created from resin powered by next-generation recycling technology that transforms plastic destined for landfills into high performance, BPA/BPS and phthalate-free bottles. Built to last, dishwasher safe. 24 oz.



ORDER NUMBER	DESCRIPTION	UNIT
1 5565-2424	Clear	EA
2 5565-2624	Slate Blue	EA

G EXECO INSULATED BOTTLE

Screw top lid. 500 mL. Stainless Steel.



ORDER NUMBER	DESCRIPTION	UNIT
1 XGB500MBK	Matte Black	EA
2 XGB500MPK	Matte Pink	EA

Breakroom Supplies – tableware

✓ **COMPOSTABLE**
REDUCE OUR FOOTPRINT



A ECO GUARDIAN™ COMPOSTABLE CUTLERY

Made from PLA, a plant based plastic. High heat tolerance up to 194 degrees. FDA and CFIA food service approved. Breaks down into toxin-free water, carbon dioxide and biomass that's rich in nutrients and can be used to fertilize soil. 6½".

ORDER NUMBER	DESCRIPTION	UNIT
1 EG-CPLA-BF6.5	Fork	50/PK
2 EG-CPLA-BK6.5	Knife	50/PK
3 EG-CPLA-BS6.5	Spoon	50/PK

✓ **COMPOSTABLE**
REDUCE OUR FOOTPRINT



B EARTHPAK COMPOSTABLE CUTLERY

This compostable cutlery is made from natural birch wood, grown with natural rainfall. Backyard compost friendly.

ORDER NUMBER	DESCRIPTION	UNIT
1 EP-WFRK6	Fork	100/PK
2 EP-WKNF6	Knife	100/PK
3 EP-WSPN6	Spoon	100/PK



C GEO BAMBOO CUTLERY SET

Reusable knife, fork and spoon set with easy-to-wash cloth bag. Large 8".

ORDER NUMBER	UNIT
XG35BAM	ST

✓ **COMPOSTABLE**
REDUCE OUR FOOTPRINT



D ECO GUARDIAN PLANT BASED CUTLERY

A perfect replacement for plastic cutlery, made from potato and corn starch. Sturdy, durable and unbreakable with a smooth texture and feel. Includes 10 each of forks, knives and spoons. Natural.

ORDER NUMBER	DESCRIPTION	UNIT
1 EGAV005	Mixed	30/BX
2 EGAK01	Forks	50/BX

NEW!



E VLB COMPOSTABLE UTENSILS

Made from cornstarch. Black.

ORDER NUMBER	DESCRIPTION	UNIT
1 57016	Forks	15/PK
2 57017	Knives	15/PK
3 57019	Soup Spoons	15/PK
4 57020	Combo Pack	15/PK

✓ **COMPOSTABLE**
REDUCE OUR FOOTPRINT

NEW!



F COMPOSTABLES BY GLOBE™ STRAWS

These paper straws are composed of environmentally friendly natural cellulose food-safe paper. BPA-Free materials will maintain sturdiness in liquids over time. Taste and odour free. 7.75".

ORDER NUMBER	UNIT
6095	250/PK

G GEO REUSABLE STAINLESS STEEL STRAWS

Four reusable straws with a cleaning brush. 8½".

ORDER NUMBER	UNIT
XG4STRSL	PK



Due to safety concerns, edible items are non-returnable.
Check online for the most current price.

Breakroom Supplies – tableware and food storage



A BOUNTY EVERYDAY NAPKIN

Handle sticky messes with a soft touch. Bounty quilted napkins provide you with the strength you've come to trust. Single-ply. 12.1"×12".

ORDER NUMBER	UNIT
37000-34884	100/PK



B WHITE SWAN® DINNER NAPKINS

Superior wet strength. Made with 100% recycled fibre and at least 88% post-consumer content. 8-fold. 15"×16".



ORDER NUMBER	DESCRIPTION	UNIT
07655	2-ply, 4"×7½" Folded	188/PK



C WHITE SWAN® LUNCH NAPKINS

White Swan® is a proud supporter of Nature Canada and is committed to a more sustainable future. Plain centre with embossed border proves an upscale finished look with reduced separation. Contains a minimum of 70% post-consumer recycled content. 1-ply. 4-fold.

ORDER NUMBER	DESCRIPTION	UNIT
1 07401	11"×13", 6½"×5½" folded	500/PK
2 61210	11⅞"×11⅞", 6⅜"×6⅜" folded	200/PK



D CHALET® DINNER NAPKINS

Superior quality in a convenient pillow pack. Contains a minimum of 30% post-consumer recycled content. 2-ply. 15"×16". White.

ORDER NUMBER	DESCRIPTION	UNIT
07130	4"×7½" Folded	100/PK



E BANQUET ROLL

White kraft, 36"×100'.

ORDER NUMBER	UNIT
P0066001	EA



F ZIPLOC® BIG BAGS

Ideal for storing anything large. 15"×15". 3 gallon.

ORDER NUMBER	UNIT
67140-70293	5/BX

G ZIPLOC® TWIST 'N LOC® CONTAINERS

Block out air and lock in freshness. Lids twist like a jar and have a leak resistant seal. Medium. 946 ml



ORDER NUMBER	UNIT
67140-29524	2/PK



H ZIPLOC® CONTAINERS

Containers are sealable with one finger (one press seal); suitable for food and non-food use.

ORDER NUMBER	DESCRIPTION	UNIT
1 67140-70030	Small square, 709 ml	4/PK
2 67140-70032	Medium square, 1,18L	3/PK
3 67140-70031	Large rectangle, 2,12L	2/PK

Breakroom Supplies – food storage



A GLAD® CLING WRAP

ORDER NUMBER	DESCRIPTION	UNIT
1 67489-10637	30 metre	EA
2 67489-10686	152 metre	EA



B RALSTON ROLL & WRAP 1001™ FOOD FILM

Dispenser box with safety slider blade. 11"W×1,001"L.

ORDER NUMBER	DESCRIPTION	UNIT
701500	305 metre	EA



C DURABLE ALUMINUM FOIL

Roll size: 12"W×50'L.

ORDER NUMBER	UNIT
YUNI50-35	EA



D GLAD® PRESS'N SEAL® MULTIPURPOSE WRAP

Leak-proof and airtight seal. Seals to surfaces like paper, plastic and wood. Create custom shaped bags to store and freeze in individual portions. Goes from freezer to microwave. 11³/₈"W×71"L.

ORDER NUMBER	UNIT
12587-70441	EA



E GLAD® ZIPPER SANDWICH BAGS

Double lock zipper seals tight, keeps freshness in. 6"W×5"H.

ORDER NUMBER	UNIT
67489-12615	50/BX



F GET REDDI® FOODSERVICE FOIL

Individually wrapped rolls for sanitary protection. FDA approved, Kosher certified. 18"W×500'L.

ORDER NUMBER	UNIT
AFW18x500	BX



G ZIPLOC® COMPOSTABLE SANDWICH BAGS

Made of compostable materials, they can reduce landfill waste and create valuable soil supplement when composted in a commercial composting centre. BNQ and BPI certified. Not for backyard composting.

ORDER NUMBER	UNIT
67140-00176	20/BX



H ZIPLOC® STORAGE BAGS

Blocks out air and locks in freshness. Smart Zip Plus® seal and Easy Open Tabs. Medium: 7"×7". 28/box. Large: 10"×10".

ORDER NUMBER	DESCRIPTION	UNIT
1 67140-00340	Medium	28/BX
2 67140-00350	Large	19/BX



I ZIPLOC® STORAGE BAGS

Easy open tabs. Smart Zip Plus® seal. Microwave safe. Write-on label.

ORDER NUMBER	DESCRIPTION	UNIT
1 19800-70763	1 quart	500/BX
2 19800-70764	1 gallon	250/BX
3 19800-70760	2 gallon	100/BX

J ZIPLOC® SANDWICH BAGS

Strong and reliable with double-zipper closure. Small. 6¹/₂"×5".

ORDER NUMBER	UNIT
19800-70762	500/BX



K ZIPLOC® FREEZER BAGS

Easy open tabs. Smart Zip Plus® seal. Microwave safe. Write-on label.

ORDER NUMBER	DESCRIPTION	UNIT
1 19800-70873	1 quart	300/BX
2 25700-71377	1 gallon	250/BX
3 19800-70761	2 gallon	100/BX



CLEANING, BREAKROOM AND FACILITIES

Breakroom Supplies – snacks



A KIND® BARS

Whole ingredients like nuts, mixed with fruits and spices bound together with honey. 40 g. 12/box.

ORDER NUMBER	DESCRIPTION	UNIT
NEW! 1 24859	Almond, Mint & Dark Chocolate	BX
2 24857	Almond, Mocha & Dark Chocolate	BX
3 17794	Almond, Caramel & Sea Salt	BX
4 17175	Almond, Sea Salt & Dark Chocolate	BX
NEW! 5 17271	Cherry Cashew & Dark Chocolate	BX
6 24024	Honey Roasted Nut & Sea Salt	BX
7 17795	Maple Glazed Pecan & Sea Salt	BX
NEW! 8 40162	Milk Chocolate Almond	BX
NEW! 9 40157	Milk Chocolate Peanut Butter	BX
10 17170	Peanut Butter & Dark Chocolate	BX



B KELLOGG'S® SPECIAL K FRUIT CRISP BARS

Sweet meets sensible. Two light crisp pastries with delicious berry taste, drizzled with a touch of icing. 25 g.

ORDER NUMBER	DESCRIPTION	UNIT
1 56757	Blueberry	12/BX
2 56759	Strawberry	12/BX



C CORN NUTS

Real corn kernels and real corn flavor. As authentic as a snack can get. 48 g.

ORDER NUMBER	DESCRIPTION	UNIT
1 06KR102-JAL18X48	Jalapeno Cheddar	EA
2 06KR102-ORIG18X48	Original	EA
3 06KR102-BBQ18X48	BBQ	EA



D HOSTESS® VARIETY PACKS

ORDER NUMBER	DESCRIPTION	UNIT
1 02H0123	18 Doritos, 12 Lay's Classic, 6 Ruffles All Dressed	36/CT
2 02H0180	12 each of Ruffles Sour Cream & Onion, Lay's Salt and Vinegar and Lay's BBQ	36/CT
3 02H0181	18 Sun Chips, 12 Miss Vickie's Sea Salt and Vinegar, 6 Miss Vickie's Original	36/CT



E CAMPBELL'S READY TO SERVE SOUP

Comforting, simple, delicious, and satisfying meal solutions any day of the week. 212 mL (7.5 oz).

ORDER NUMBER	DESCRIPTION	UNIT
1 17CA102-CHICKRIC80Z	Chicken with Rice	EA
2 17CA102-TOMATO80Z	Tomato	EA

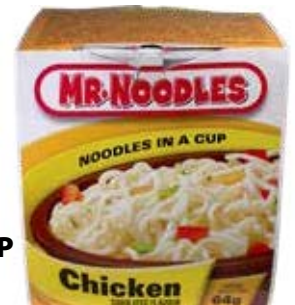

F MR. NOODLES IN A CUP

Simply add hot water. 64 g.

ORDER NUMBER	DESCRIPTION	UNIT
1 17MN100-VEG12X64	Vegetable	12/CT
2 17MN100-SPCCHIC12X64	Spicy Chicken	12/CT
3 17MN100-CHICKEN12X64	Chicken	12/CT
4 17MN100-BEEF12X64	Beef	12/CT



**A COTTAGE®
COUNTRY NUTS**

Something for your Nutty side to enjoy.

ORDER NUMBER	DESCRIPTION	UNIT
1 82311	100g Salted Peanuts	PK
2 92108	45g Salted Cashews	PK



B HERSHEY TWIZZLERS

These delicious, strawberry-flavored twists are where it all began. Open up a pack to share, or not. Peanut free. 90g.

ORDER NUMBER	UNIT
82502	PK



C LIFESAVERS®

ORDER NUMBER	DESCRIPTION	UNIT
1 07WR113-5FLVR20X32	5 Flavours, 32 g	PK
2 07WR165	5 Flavours, 150 g	PK
3 07WR128-PMINT150GR	Pep-o-Mint, 150 g	PK
4 07WR128-WINTGRN150GR	Wint-o-Green, 150 g	PK



**D WERTHER'S®
ORIGINAL® CANDY**

Made with real butter and fresh cream.

ORDER NUMBER	DESCRIPTION	UNIT
1 07MI133	Hard Candy, 50 g	PK
2 07MI301	Hard Candy, 135 g	PK
3 07MI328	Hard Candy, 900 g	PK
4 07MI299	Chewy Caramels, 128 g	PK
5 07MI323	Soft Crème Caramels, 128 g	PK
6 07MI334	No Sugar Added Hard Candy, 70 g	PK



**E ROLAIDS®
EXTRA STRENGTH
ANTACID CHEWABLE TABLETS**

There's never a good time to have heartburn. Rolaid's® Extra Strength tablets for fast, powerful relief from heartburn symptoms. Relieves: heartburn, sour stomach, acid indigestion. Assorted Fruit.

ORDER NUMBER	UNIT
25MI358	12/PK

Due to safety concerns, edible items are non-returnable.
Check online for the most current price.



F DARE® MINTS

Individually wrapped hard candy with a peppermint-flavoured stripe.

ORDER NUMBER	UNIT
07MI228-P/MINTRD1000CT	1000/CT

Breakroom Supplies – small appliances



A ROYAL SOVEREIGN® 2.6 CU. FT. REFRIGERATOR

Large capacity for shared use in larger offices. Interior light and adjustable thermostat. Reversible door with magnetic seal. Recessed handle and adjustable feet. Two glass shelves and one shelf in freezer. Three full door balconies and fruit and vegetable crisper. 7.6 cu. ft. capacity (including 1.6 cu. ft. freezer). 21 $\frac{1}{2}$ "W×22 $\frac{3}{8}$ "D×55 $\frac{1}{2}$ "H. Stainless Steel.

ORDER NUMBER	UNIT
RMF-2155S	EA



B ROYAL SOVEREIGN® 4 CU. FT. REFRIGERATOR

4.0 cu ft. compact refrigerator features a reversible door, can storage dispenser, 2 L bottle rack, adjustable glass shelves, and separate ice box. 18 month warranty. Dimensions: 18 $\frac{1}{2}$ "W×20 $\frac{1}{2}$ "D×33 $\frac{3}{8}$ "H.

ORDER NUMBER	DESCRIPTION	UNIT
1 RMF-113B	Black	EA
2 RMF-113SS	Stainless Steel	EA

C ROYAL SOVEREIGN® 2.6 CU. FT. REFRIGERATOR

2.6 cu. ft. capacity, 17 $\frac{1}{2}$ "W×19 $\frac{3}{8}$ "D×25"H. Includes ice box with tray, adjustable thermostat, reversible door with magnetic seal, flat back, 2 glass shelves, can storage, and 2 L bottle rack. 18-month warranty. White.

ORDER NUMBER	UNIT
RMF-70W	EA



D BLACK + DECKER® TOASTERS

Features extra-wide slots with self-centering guides, dual independent controls, and a cancel function. 2-year limited warranty.



ORDER NUMBER	DESCRIPTION	UNIT
1 TR1278BD	2-Slice	EA
2 TR1478BD	4-Slice	EA



E BLACK + DECKER® TOASTER OVEN

Features bake, broil and toast functions, 2 rack slot positions and curved interior to hold a 9" pizza or four slices of bread. Includes bake pan and broil rack. Removable crumb tray. Two year limited warranty. 6.4×11.3×9.4"

ORDER NUMBER	UNIT
T01755SBC	EA

Breakroom Supplies – small appliances

NEW!



A ROYAL SOVEREIGN® 4 IN 1 MICROWAVE

Combines the features of a microwave, air fryer, oven and dehydrator in one unit. 900-watt. Digital panel to customize temperature, 12²/₅" glass turntable for even cooking, child safety lock. 1.1 cu. ft. capacity.

ORDER NUMBER	UNIT
RMW30-1000SS	EA

NEW!



B ROYAL SOVEREIGN® COUNTERTOP MICROWAVE

Ideal for the home and workplace. 900-watt. Features 10 power levels, one touch cooking options and 2-stage cooking. Stylish classic stainless steel design. 0.9 cu. ft. capacity. 19"W×13³/₅"D×10³/₄"H. 1-year warranty. 3-year warranty on magnetron tube. Black.

ORDER NUMBER	UNIT
RMW25-900SS	EA



C ROYAL SOVEREIGN® TRI-TEMPERATURE BOTTOM LOAD WATER DISPENSER

Hands-free paddle design tri-temperature bottom load water dispenser, dispenses boiling hot, room and cold water. The bottled water is conveniently stored at the base of the unit & pumps water into the stainless steel tanks - no need to lift heavy water bottles and no accidental spills. Features a 2-step child safety lock and compressor cooling. White.

ORDER NUMBER	UNIT
RWD-1750S	EA



NEW!

D ROYAL SOVEREIGN® TRI-TEMPERATURE TOP LOAD WATER DISPENSER

Dispense hot, room temperature and cold water. Hot and cold water can be turned off separately when not needed to conserve energy. Hands free paddle design. 2-step child safety lock for hot water. Convenient storage cabinet, LED indicator lights, and stainless steel water tank. For use with standard 3 or 5 gallon bottles. White.

ORDER NUMBER	UNIT
RWD-900S	EA



NEW!

E ROYAL SOVEREIGN® COMPACT HANDS-FREE COUNTERTOP WATER DISPENSER

Ideal for office breakrooms, reception, meeting rooms and homes. Dispenses both hot and cold water using the hands-free paddle design. 2 Step child safety lock on hot water button, efficient thermoelectric cooling, stainless steel water tank, and removable dishwasher safe spill tray. Use with standard 3 or 5 gallon bottles. Black.

ORDER NUMBER	UNIT
RWD-180B	EA



F FROST CUP DISPENSER

Water cup dispenser. Holds 200 cups. Includes mounting hardware.

ORDER NUMBER	UNIT
1 185	EA
DART CONE WATER CUPS	
Treated paper cup with rolled rim. Designed for cold applications. 4 oz.	
2 4BR-2050	200/PK

CLEANING, BREAKROOM
AND FACILITIES

Check online for the most current price.

Cleaning Supplies – dish soaps and detergents



A CASCADE® PLATINUM DISHWASHER PACS

Advanced triple action formula helps prevent residue on your dishes and film on your dishwasher. Eliminates the need to pre-wash. Scrubs away tough 24-hour stuck-on food. Fresh Scent.

ORDER NUMBER	UNIT
37000-89329	60/PK



B FINISH® POWERBALL® ALL IN 1 MAX™ DISHWASHER TABS

Powerful cleaners remove the toughest stains. Gently scrubs your dishes, glasses and silverware. Jet-Dry Rinse Agent action helps rinse away residue, eliminating spots and film for a sparkling shine.

ORDER NUMBER	UNIT
CB367723	55/BX



C CASCADE® ACTIONPAC® DISHWASHER PACS

Cleaner and rinse in one convenient pack. Fresh Scent.

ORDER NUMBER	DESCRIPTION	UNIT
1 37000-98082	Fresh Scent	25/PK
2 37000-98120	Lemon	90/PK



D FINISH® JET-DRY® RINSE AID

With 5X Power. Contains glass protection ingredient for shinier and drier dishes. 250 ml.

ORDER NUMBER	UNIT
CB815081	EA

E CASCADE® POWER DRY™ RINSE AID GEL

Provides outstanding spot and film protection. Helps dishes truly shine.

ORDER NUMBER	DESCRIPTION	UNIT
37000-89629	901 ml	EA



Cleaning Supplies – dish soaps and detergents



A DAWN® ULTRA DISH DETERGENT

Powers away greasy messes for sparkling dishes, pots, and pans.

ORDER NUMBER	DESCRIPTION	UNIT
1 30772-00908	650 ml Original EZ-Squeeze	EA
2 30772-00614	473 ml Original	EA

DAWN® ULTRA ANTIBACTERIAL DISH DETERGENT

Cleans up to 2x more greasy dishes per drop vs. non-concentrated Dawn while suds last.

3 30772-00602	473 ml Apple Blossom®	EA
4 30772-00604	473 ml Orange	EA



B DAWN® PROFESSIONAL POT AND PAN DETERGENT

Formula seeks out greasy soil and cuts through it. Lifts and removes dirt from your dishes.

ORDER NUMBER	DESCRIPTION	UNIT
1 30772-03024	1.12 L	EA
2 30772-03027	3.78 L	EA



C SUNLIGHT® LEMON FRESH DISH DETERGENT

The classic formula combines tough grease-fighting action with an invigorating lemon fresh scent.

ORDER NUMBER	DESCRIPTION	UNIT
1 72613-73931	800 ml	EA
2 72613-75015	4.2 L	EA

D ULTRA SUNLIGHT® ANTIBACTERIAL DISHWASHING LIQUID

Kills 99.9% of bacteria. 562 ml.

ORDER NUMBER	DESCRIPTION	UNIT
1 72613-73925	Green Apple	EA
2 72613-73924	Orange	EA



E ULTRA SUNLIGHT® OXI ACTION™

Cuts through grease with rich, thick suds to get your dishes sparkling clean while being gentle on your hands. Lemon. 562 ml.

ORDER NUMBER	UNIT
72613-73926	EA



F IVORY® CONCENTRATED DISH DETERGENT

Gentle on hands, hard on grease. The special formula won't remove the natural oils in your skin, giving you soft hands as well as sparkling dishes. Classic scent. 573ml.

ORDER NUMBER	UNIT
37000-75100	EA



G MRS. MEYER'S® CLEAN DAY DISH SOAP

Glycerine and Aloe Vera soften and moisturize hands while you wash. Concentrated formula includes soap bark extract, one of nature's best degreasers. 473 ml.

ORDER NUMBER	DESCRIPTION	UNIT
1 62300-00157	Geranium scent	EA
2 59200-70847	Lemon Verbena scent	EA
3 59200-70859	Basic scent	EA
4 59200-70865	Lavender scent	EA

Cleaning Supplies – sponges, scrubs and cloths



A SCOTCH-BRITE™ HEAVY DUTY DISHWAND

Teardrop-shaped scrubber gets into corners.

ORDER NUMBER	DESCRIPTION	UNIT
1 650-12-RRP	Original	EA
2 481-12-RSC-RRP	SCOTCH-BRITE™ DISHWAND REFILLS Heavy duty	2/PK
3 SB483-CA	No-scratch	2/PK

NEW!

B SCOTCH-BRITE™ ADVANCED SOAP CONTROL DISHWAND

Two different bristle materials boost scrubbing power and last longer. Antimicrobial biocide helps bristles resist odours. Soft-touch surface provides a non-slip grip. Leakproof, no matter how the wand is stored. Button for precise soap dispensing.

ORDER NUMBER	UNIT
751U-6-RRP-CA	EA



C SCOTCH-BRITE™ BOTTLE SCRUBBER

The contoured and flexible tip fits into corners that are usually difficult to reach and clean. Dishwasher safe.

ORDER NUMBER	UNIT
507	EA



D SCOTCH-BRITE™ POT, PAN & DISH BRUSH

Double sided cleaning head for versatile cleaning. Tough bristle row for baked-on residue and a flexible bristle head for general cleaning.

ORDER NUMBER	UNIT
496P-8-CA	EA



E SCOTCH-BRITE™ HANDY SPONGES

Handy Sponge is a cleaning caddy staple, great for cleaning every room of the house. This product is long lasting and can be sanitized in the dishwasher and reused.

ORDER NUMBER	UNIT
HP-4	4/PK



F SCOTCH-BRITE™ NO-SCRATCH SCRUB SPONGES

Quickly clean surfaces without leaving marks or scratches. Sanitize in the dishwasher and re-use. Easy to hold shape. Blue.

ORDER NUMBER	UNIT
MP-6-8-CA	6/PK



G SCOTCH-BRITE™ HEAVY DUTY SCOUR PADS

Effective alternative to scrapers and steel wool. Great for indoor and outdoor use where abrasion is needed.

ORDER NUMBER	UNIT
SB411	4/PK



H SCOTCH-BRITE™ HEAVY DUTY SCRUB SPONGES

Sometimes the mess is just too tough for a regular scrub sponge. Easily removes tough, baked-on messes.

ORDER NUMBER	UNIT
HDG-8CA	6/PK



I S.O.S.® STEEL WOOL SOAP PADS

Removes tough grease and grime quickly and easily.

ORDER NUMBER	UNIT
55500-01177	18/BX

BIODEGRADABLE!



A J CLOTH BIODEGRADABLE REUSABLE CLOTHS

J Cloths are the environmentally friendly alternative to paper towels for everyday cleaning. 11"×18³/₂". Blue.

ORDER NUMBER	UNIT
51071	8/PK



B CHIX® 3000 COMPOSTABLE FOODSERVICE TOWELS

Picks up light soils & liquids. Easy to rinse, fast-drying, lightweight. Long-lasting, reduces paper towel use. 12¹/₂"×21". Green.

ORDER NUMBER	UNIT
3000 CHIX	50/BG

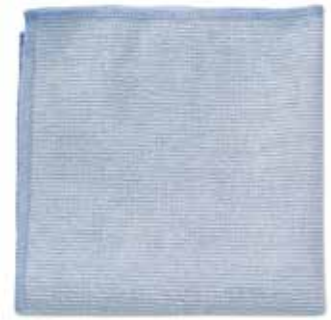

C RUBBERMAID® MICROFIBRE CLEANING CLOTH

For light commercial use. Proven to remove 99.9% of microbes. Bleach-safe and durable to withstand 100 launderings. 12"×12". Blue.

ORDER NUMBER	UNIT
1820579	24/PK

Rinse & REUSE!



D CHIX DISPOSABLE CLOTH TOWELS

Rinse and re-use. Lintless non-woven material. 13¹/₂"×24".

ORDER NUMBER	UNIT
8506	100/PK



E SCOTCH-BRITE™ MICROFIBRE KITCHEN CLOTHS

High performance cleaning cloth with unique fibres. Effectively picks up dust, grime, grease & fingerprints on every surface. 8¹/₂"×6¹/₂".

ORDER NUMBER	UNIT
9032-2CA	2/PK



F WYPALL® X60 REINFORCED WIPES

Reinforced for extra scrubbing and cleaning power. 12¹/₂"×16¹/₈".

ORDER NUMBER	UNIT
54015	252/CT



G GLOBE™ MICROFIBRE CLOTHS

Perfect for all your commercial cleaning needs. Reduce chemical spills and pick up more bacteria. Withstands hundreds of launderings. 16"×16".

ORDER NUMBER	DESCRIPTION	UNIT
1 3130B	Blue	10/PK
2 3130R	Red	10/PK
3 3130G	Green	10/PK
4 3130Y	Yellow	10/PK
5 3199	Assorted colours	12/PK



H WYPALL® SHOP PRO X80 WIPES

Use to clean heavy machinery, prep surfaces with solvents and wipe down shop tables. 12¹/₂"×16¹/₈". Blue.

ORDER NUMBER	UNIT
41041	160/CT

CLEANING, BREAKROOM AND FACILITIES

Cleaning Supplies – spray bottles, brushes and pails



A GLOBE™ FUNNEL

Allows for easy pouring of disinfectants, soaps, chemicals and more into any size of container. Can also be used for automotive needs. Convenient, durable, sturdy and economical. Easy to clean and rinse. Can be used for hand sanitizers. 6" wide. White.

ORDER NUMBER	UNIT
9389	EA



B GLOBE™ POINTED SCRUB BRUSH

Large shape for maximum hand scrubbing power. 9".

ORDER NUMBER	UNIT
3620	EA



C GLOBE™ HAND SCRUB BRUSH

Scrub brush with iron design has an ergonomic handle for grip. Polypropylene bristles make it resistant to most acids and solutions. BPA-free, safe for use in foodservice areas. 6".

ORDER NUMBER	UNIT
4005	EA

D GLOBE™ SPRAY BOTTLE

Easily measure chemicals and water ration with these commercial duty spray bottles. Perfect for industrial, janitorial, food service and healthcare. A standard in cleaning and disinfecting surfaces. Easy solution mixing capacity. High density polyethylene. Works with any standard trigger. Sturdy professional grade. 32 oz.



ORDER NUMBER	UNIT
3572	EA



F GLOBE™ HYGIENE-PAIL™

Dedicated-use, labelled containers for cleaning and sanitizing solutions. Colour-coding reduces risks of cross-contamination. 2.8 L.

ORDER NUMBER	DESCRIPTION	UNIT
1 3603B	Blue	EA
2 3603R	Red	EA
3 3603G	Green	EA
4 3603Y	Yellow	EA

E GLOBE™ CHEMICAL-RESISTANT TRIGGER SPRAYER

Synthetic O-ring and piston cup that holds up against the harshest chemicals. Long-lasting outer body that protects piston assembly to prevent damage during use and storage. High output and X large spray pattern. Great for harsh chemicals, automotive detailing, car washes, carpet spot cleaning, and general use. 9¼". Grey.



ORDER NUMBER	UNIT
3560	EA

CLEANING, BREAKROOM AND FACILITIES



G RUBBERMAID® DELUXE CARRY CADDY

All purpose caddy perfect for carrying tools or cleaning supplies. Fits on cleaning and housekeeping carts. Securely holds up to eight 32 oz spray bottles and other common cleaning tools. Ergonomic handle design provides comfortable fit. 15"W×11"D×7½"H.

ORDER NUMBER	UNIT
FG315488BLA	EA



H GLOBE™ BOTTLES AND SPRAYERS

Great for residential, industrial and office cleaning needs. Molded in measurement lines. Leak proof spray head. Three finger trigger and adjustable nozzle. 24 oz..

ORDER NUMBER	UNIT
3570	3/PK



I COMMAND™ SPRAY BOTTLE HANGERS

Neatly store your spray bottles out of sight but within reach. Simple to install – no tools required and no damage to your cabinet doors or walls. 2.5 lb capacity. White.

ORDER NUMBER	UNIT
17009-HW2EF	2/PK



**A AVMOR®
ECOPURE™ EP76™
CREAM CLEANER**

Removes soil, stubborn stains, grease, soap scum and scuff marks from a variety of surfaces. Clings to both vertical and horizontal surfaces. Phosphate free. No NPE's or VOC's.



ORDER NUMBER	DESCRIPTION	UNIT
101106941	946 ml	EA

**B TWINKLE®
STAINLESS STEEL
CLEANER & POLISH**

Water-based aerosol cleaner and polish beautifies stainless steel, brass and chrome. Leaves no oily film. Polishes as it cleans, effectively removing grease, dirt, fingerprints, smudges and watermarks.



ORDER NUMBER	DESCRIPTION	UNIT
991224	482 g	EA

**C PLEDGE®
STAINLESS STEEL
CLEANER & POLISH**

Removes fingerprints, smudges, smears and messes without leaving a waxy buildup. Fresh citrus fragrance.



ORDER NUMBER	DESCRIPTION	UNIT
62300-00421	275 g	EA

**D DAWN®
PROFESSIONAL
MULTI-SURFACE
HEAVY DUTY
DEGREASER**

True multi-surface degreaser with the ability to cut tough grease on greasy surfaces, stainless steel, range hoods, ovens, walls, outdoors and more.



ORDER NUMBER	DESCRIPTION	UNIT
30772-02703	946 ml	EA

**E WD-40® SPECIALIST
INDUSTRIAL
STRENGTH CLEANER
& DEGREASER**

Industrial strength Bio-Solvent technology that protects from rust. Safer choice. Certified Biodegradable. Non-flammable, low odour and fragrance free. Safe to use in food-processing facilities. NSF Registered A1, A2, A4, A8, B1.



ORDER NUMBER	DESCRIPTION	UNIT
61536-01233	946 ml	EA

**F DRANO®
KITCHEN
GEL CLOG
REMOVER**

Clings to tough clogs, including kitchen grease to blast them fast. Cuts through standing water. Safe on all pipes and garbage disposals.



ORDER NUMBER	DESCRIPTION	UNIT
59200-00204	473 ml	EA

**G LIQUID-
PLUMR®
CLOG
REMOVER**

Takes on the toughest clogs. Thick gel holds together to cut through standing water and attack built-up hair, gunk and soap scum. Works fast, eliminating stubborn blockages and leaves your drain free-flowing and clog-free. Full Clog Destroyer is safe for all garbage disposals, septic systems and pipes, including PVC, plastic, copper and old pipes.



ORDER NUMBER	DESCRIPTION	UNIT
55500-01811	900 ml	EA

**H DRANO®
MAX GEL CLOG
REMOVER**

Thick bleach formula cuts right through standing water, clinging to your toughest clogs to blast them fast. It works great to remove hair, soap scum, and other gunky clogs. Safe for garbage disposals, bathroom, kitchen and other drains like laundry sinks.



ORDER NUMBER	DESCRIPTION	UNIT
59200-00723	900 ml	EA

**I DRANO®
KITCHEN
GRANULES**

Designed to destroy tough, greasy kitchen clogs. The formula heats water to quickly melt grease clogs. Works in 15 minutes.



ORDER NUMBER	DESCRIPTION	UNIT
59200-00588	500 g	EA

CLEANING, BREAKROOM
AND FACILITIES



A WINDEX® FOAMING GLASS CLEANER

Streak free shine. Stays where you spray. Ammonia-D® added.

ORDER NUMBER	DESCRIPTION	UNIT
19800-00387	560 g	EA



B WINDEX® CLEANER

Cleans with Ammonia-D® for a streak-free shine. Loosens soil upon contact. Won't streak or leave a film. Contains no phosphates.

ORDER NUMBER	DESCRIPTION	UNIT
1 19800-70765	946 ml	EA
2 19800-70759	Refill 3.8 L	EA



C WINDEX® VINEGAR MULTI SURFACE CLEANER

Versatile enough to use throughout your home, and the special ammonia-free formula has no harsh vinegar smell — just a fresh, clean scent. Use as a bathroom cleaner, kitchen cleaner, tile cleaner, stainless steel cleaner, and much more. Bottle is now made from Ocean Bound plastic.

ORDER NUMBER	DESCRIPTION	UNIT
59200-81796	765 ml	EA



D WINDEX® MULTI SURFACE NON-AMMONIATED CLEANER

Loosens soil upon contact. Won't streak or leave a film. Contains no phosphates. Trigger.

ORDER NUMBER	DESCRIPTION	UNIT
19800-70884	946 ml	EA



E WINDEX® ORIGINAL GLASS WIPES

Convenient for quickly cleaning windows, mirrors and much more. It's the easiest way to get that famous streak-free clean almost anywhere in your home. 28 count.

ORDER NUMBER	UNIT
59200-00128	PK



F GLOBE™ GLASS AND MIRROR CLOTH

Premium flat woven microfibre designed to leave a streak-free finish. Reduce chemical usage. 14"×14".

ORDER NUMBER	UNIT
3129GCP	EA

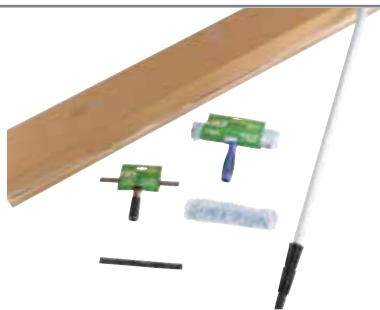

G GLOBE™ 14" COMMERCIAL WINDOW CLEANING SET

Complete kit for all your window care needs with steel squeegee which is lighter and stronger than brass, and polyester scrubbing material with double sewn seams. Includes 14" stainless steel squeegee, 14" replacement rubber, 14" T-bar and microfibre washing sleeve, 14" replacement microfibre sleeve and 12' telescopic extension pole.

ORDER NUMBER	UNIT
4467	KT



H GLOBE™ SQUEEGEE

Heavy metal frames are zinc plated and corrosion resistant. Blade is secured in place with sturdy rust-resistant screws. Windshield Squeegee. Mesh squeegee with extra stiffeners. 10".

ORDER NUMBER	UNIT
4105	EA



I GLOBE™ DOUBLE SIDED WINDOW SQUEEGEE AND WASHING SLEEVE

Scrub windows with microfibre sleeve and then squeegee for a streak-free shine. 1 tool for 2 jobs. Machine washable sleeve. 12".

ORDER NUMBER	UNIT
4465	EA

CLEANING, BREAKROOM AND FACILITIES

Cleaning Supplies – disinfecting wipes

A CLOROX® WIPES DISINFECTING

Great for cleaning and fighting bacteria and virus. These disinfecting wipes kill 99.9% of bacteria, including cold and flu, Staph, Strep, E.coli, Salmonella and Listeria. The powerful cleaning technology dissolves kitchen grease and fights soap scum. Kills SARS-CoV-2 virus (causes COVID-19).



B CLOROX® DISINFECTING ON-THE-GO WIPES

Disinfectant, cleaner and sanitizer kills 99.99% of bacteria and viruses. Fresh floral scent.



ORDER NUMBER	DESCRIPTION	UNIT
1 55500-01602	Fresh scent, 35 wipes	EA
2 55500-01609	Fresh scent, 75 wipes	EA
3 55500-01603	Lemon scent, 35 wipes	EA
4 55500-01608	Lemon scent, 75 wipes	EA

ORDER NUMBER	UNIT
1 55500-34346	15/PK
2 55500-34345	30/PK

C OXIVIR® TB WIPES

Hospital grade disinfectant. AHP technology. Kills TB, Norovirus, HIV, etc. in 1 minute. Non-irritating. No VOCs. Three year shelf life. 160 sheets/tub.



NEW!



D ZYTEC® GERM BUSTER® ALL-IN-ONE DISINFECTANT WIPES

Kills 99.99% of viruses, germs and bacteria including SARS-CoV-2 in 30 seconds. Disinfects, sanitizes and cleans. For use at home or offices, schools, health care facilities, and other commercial and institutional settings.



E ZYTEC® GERM BUSTER® ADVANCED SURFACE DISINFECTING WIPES

Advanced disinfectant wipes with benzalkonium chloride kill 99.99% of viruses, germs and bacteria. For use at home or offices, schools, health care facilities, hospitals and other commercial and institutional settings. Leaves no sticky residue, effective against human coronavirus (Strain 229E).



ORDER NUMBER	UNIT
5144708	EA

ORDER NUMBER	DESCRIPTION	UNIT
1 60480-01861	100 wipes/tub	EA
2 60480-01862	800 wipes/pail	EA

ORDER NUMBER	DESCRIPTION	UNIT
60480-01855	100 wipes/tub	EA

F CLOROX HEALTHCARE™ BLEACH GERMICIDAL WIPES

One-step cleaner and disinfectant. Premoistened, strong, durable, cloth-like wipe. Health Canada-registered to kill C. difficile spores in 3 minutes, and 46 pathogens in 1 minute. 70 sheets/tub.



G CLOROX HEALTHCARE™ HYDROGEN PEROXIDE CLEANER DISINFECTANT WIPES

Pre-moistened, durable cloth-like wipes for everyday cleaning and high-touch surfaces. Health Canada registered disinfectant. Kills 38 pathogens in 1 minute or less. 6¾"×9". 95 sheets/tub.



NEW!



H ZYTEC® HEALTHCARE ALL IN ONE DISINFECTANT WIPES

Triple action. All-in-one formula disinfects, sanitizes and deodorizes. Kills 99.99% of viruses, germs and bacteria including SARS-CoV-2. For use at health care facilities, hospitals, clinics, dental offices, schools, and daycares. 180 sheets/tub.



ORDER NUMBER	UNIT
55500-01308	EA

ORDER NUMBER	UNIT
55500-01456	EA

ORDER NUMBER	UNIT
60480-01867	EA

CLEANING, BREAKROOM AND FACILITIES

Cleaning Supplies – disinfecting cleaners

NEW!



A FAMILY GUARD™ DISINFECTANT CLEANER

Kills 99.9% of viruses, germs and bacteria; including the SARS-CoV-2 virus that causes Covid-19. Trigger Spray. Nurtures and protects, pleasant fragrance, and easy to use. 946 ml.

ORDER NUMBER	DESCRIPTION	UNIT
1 62913-00151	Citrus scent	EA
2 62913-00150	Fresh scent	EA

NEW!



B FAMILY GUARD™ DISINFECTANT SPRAY

Kills 99.9% of viruses, germs and bacteria; including the SARS-CoV-2 virus that causes Covid-19. Aerosol spray. Nurtures and protects, pleasant fragrance, and easy to use. 496 g.

ORDER NUMBER	DESCRIPTION	UNIT
1 62913-00149	Citrus scent	EA
2 62913-00152	Fresh scent	EA

NEW!



C SPIC AND SPAN® ALL PURPOSE DISINFECTING CLEANER

Powerful 3-in-1 formula offers remarkable cleaning performance as a disinfectant, hard surface cleaner and glass cleaner.

ORDER NUMBER	DESCRIPTION	UNIT
56100-00639	946 ml	EA



D AVMOR® ECOPURE™ EP50™ CLEANER DISINFECTANT

Hydrogen Peroxide Solution. Oxidizing multi-purpose degreaser and deodorizer for hard, non-porous surfaces. Designed for use in hospitals, nursing homes, hotels, schools and food service establishments.

ORDER NUMBER	DESCRIPTION	UNIT
101106943	3.78 L	EA

NEW!



E MR. CLEAN® MULTI SURFACE DISINFECTANT CLEANER

Removes grease, kills germs including the flu virus. Cleans surfaces with a streak-free shine. Summer Citrus scent.

ORDER NUMBER	DESCRIPTION	UNIT
1 37000-77131	1.3 L	EA
2 37000-31504	3.78 L	EA

F DIVERSEY™ OXIVIR® TB DISINFECTANT

Ready-to-use disinfectant cleaner based on proprietary hydrogen peroxide technology to deliver fast, effective cleaning. Disinfects in 60 seconds. No VOC's, no added fragrance. Non-corrosive. Meets blood borne standard for decontaminating blood and bodily fluids. 946 mL.

ORDER NUMBER	DESCRIPTION	UNIT
4277293	Lemon	12/CT



CLEANING, BREAKROOM AND FACILITIES

G PLEDGE® MULTI SURFACE CLEANER DISINFECTANT

Cleans and disinfects. Pleasant citrus scent. Use on sealed wood laminate, glass, mirrors, stainless steel, plastics, chrome and electronics.

ORDER NUMBER	UNIT
62300-70688	EA



H PINE-SOL® SURFACE DISINFECTANT CLEANER

Cleans & deodorizes floors, tiles, sinks, showers and garbage cans. Biodegradable and phosphate-free.

ORDER NUMBER	DESCRIPTION	UNIT
1 55500-40154	1.41 L	EA
2 55500-01166	4.25 L	EA

I WINDEX® ANTIBACTERIAL MULTI SURFACE CLEANER

Clean and shine your surfaces without any dull residue. It kills 99.9% of germs and bacteria on hard, non-porous surfaces. Great for cleaning bathrooms, kitchens, tiles, stainless steel, and more.

ORDER NUMBER	DESCRIPTION	UNIT
1 59200-81772	765 ml	EA
2 59200-00308	3.78 L	EA



NEW!

Cleaning Supplies – disinfecting cleaners



A ZYTEC® GERM BUSTER® ALL IN ONE DISINFECTING SPRAY

Cleans, deodorizes and disinfects. Kills 99.99% of viruses and bacteria. For use at home or offices, schools, health care facilities, hospitals and other commercial and institutional settings. Fast, effective broad-spectrum Virucide, leaves no stickiness or residue.

ORDER NUMBER	DESCRIPTION	UNIT
1 60480-01860	Spray 400 ml	EA
2 60480-01864	Pump 946 ml	EA



B LYSOL® DISINFECTANT SPRAY

Kills 99.9% of mould, mildew and bacteria. Crisp Linen. 350 g.

ORDER NUMBER	DESCRIPTION	UNIT
34052		EA



C MICROBAN® 24 HOUR DISINFECTANT

Keeps killing 99.9% of bacteria for up to 24 hours, even after multiple touches. Fresh scent.

ORDER NUMBER	DESCRIPTION	UNIT
1 37000-48774	Sanitizing Spray 354 g	EA
2 37000-48587	Multipurpose Cleaner 946 ml	EA



D ZYTEC® GERM BUSTER® CITRIC ACID DISINFECTANT

Kills 99.99% of viruses and bacteria. For use at home or offices, schools, health care facilities, hospitals and other commercial and institutional settings. Great for cleaning. Lemon scent.

ORDER NUMBER	DESCRIPTION	UNIT
1 60480-01264	946 ml Pump	EA
2 60480-01265	3.78 L Refill	EA
3 60480-01260	400ml Spray	EA



E CLOROX® CLEAN-UP DISINFECTANT BLEACH CLEANER

Cleans and disinfects, killing bacteria on counters, tiles, sinks and showers. Contains an anticorrosion agent. 946 ml.

ORDER NUMBER	DESCRIPTION	UNIT
55500-01402		EA



F LYSOL® ALL PURPOSE DISINFECTANT CLEANER

Kills 99.9% of viruses and bacteria on hard surfaces. 650 ml.

ORDER NUMBER	DESCRIPTION	UNIT
75227	Lemon	EA



G CLOROX® GERMICIDAL BLEACH

Kills 99.9% of germs, E.Coli, Listeria and Salmonella. Concentrated formula gives more cleaning and whitening power. 3.58 L.

ORDER NUMBER	DESCRIPTION	UNIT
55500-01383		EA



H FANTASTIK® ALL PURPOSE DISINFECTING CLEANER

Cleans and fights tough grease and grime on just about any surface. This all purpose cleaner kills 99.9% of bacteria as it cleans, and kills the Flu virus, E.coli and Salmonella.

ORDER NUMBER	DESCRIPTION	UNIT
1 62913-00078	946 ml trigger	EA
2 62913-00079	3.81 L refill	EA
3 62913-03316	946 ml trigger with Bleach	EA



I CLOROX HEALTHCARE™ BLEACH GERMICIDAL CLEANER

Health Canada registered, one step, ready-to-use hospital-grade disinfectant. Perfect for toilet bowls and sinks. Effective against C. difficile spores in 5 minutes and 36 pathogens in 1 minute. 946 ml.

ORDER NUMBER	DESCRIPTION	UNIT
55500-01416		EA

CLEANING, BREAKROOM AND FACILITIES

Check online for the most current price.

Cleaning Supplies – multi-purpose cleaners

NEW!



A CLOROX® GREEN WORKS® CLEANING WIPES

Produced without harsh chemicals and fumes. Effectively clean multiple hard surfaces throughout the home. Made from a durable plant-based cloth. Safe to use around kids, pets and food. Bleach free. 75 sheets/tub.

ORDER NUMBER	DESCRIPTION	UNIT
1 55500-55872	Simply Lemon	EA
2 55500-55873	Unscented	EA



B PINE-SOL® SURFACE CLEANER

Cleans & deodorizes floors, tiles, sinks, showers and garbage cans. Biodegradable and phosphate-free. 1.41 L

ORDER NUMBER	DESCRIPTION	UNIT
1 55500-50225	Lemon	EA
2 55500-40290	Lavender	EA

NEW!



C PLEDGE® PH BALANCE MULTI-SURFACE CLEANER

Works on most hard, non-porous surfaces such as chrome, electronics, glass, laminate, plastic, sealed granite, sealed marble, sealed quartz, sealed wood, stainless steel and more. Fresh Citrus.

ORDER NUMBER	DESCRIPTION	UNIT
62300-00794	750 ml	EA



D MRS. MEYER'S® CLEAN DAY MULTI SURFACE CLEANER

Combines garden-inspired scents, essential oils, and plant-derived cleaning ingredients to clean kitchen messes all over the house. Great on non-porous surfaces. 473 ml.

ORDER NUMBER	DESCRIPTION	UNIT
1 59200-70858	Basil	EA
2 59200-70848	Lemon Verbena	EA
3 59200-70864	Lavender	EA
4 62300-00158	Geranium	EA

E MR. CLEAN® CLEAN FREAK DEEP CLEANING MIST

Muscle through grime, tough dirt and grease to make messes a distant memory. Mist activates on contact and leaves your home smelling fresh with a lemon zest scent. Power Nozzle™ offers large coverage. Includes refill bottle.

ORDER NUMBER	DESCRIPTION	UNIT
37000-79129	473 ml	EA



CLEANING, BREAKROOM AND FACILITIES

F MR. CLEAN® MAGIC ERASER®

Removes set in dirt on stoves, refrigerators and other appliances. Cleans scuff marks and dirt from walls, floors and doors.

ORDER NUMBER	DESCRIPTION	UNIT
1 37000-01494	Original	2/BX
2 37000-79009	Original	6/BX
3 37000-04249	Extra Durable	2/BX



G GLOBE™ ERASER SPONGE

Made from the same non-toxic material as the big brand at a fraction of the cost. Strong enough to use on any grit, grime or dirt. 4¾"×2¾"×1¾".

ORDER NUMBER	UNIT
4027	4/PK

Cleaning Supplies – restroom cleaning

A MICROBAN® 24 HOUR BATHROOM CLEANER

Keeps killing pathogens for up to 24 hours as it cleans, sanitizes, and disinfects. The powerful formula destroys soap scum and prevents the growth of mold and mildew. Use on counters, sinks, toilets, bathtubs, showers, tiles, and more. 946 ml.



ORDER NUMBER	UNIT
37000-48621	EA

B COMET® DISINFECTING CLEANSER WITH BLEACH

Fine abrasive scouring cleanser with bleach removes tough stains and deodorizes as it cleans. Designed for use on fiberglass tubs, imitation marble and other hard plastic surfaces.



ORDER NUMBER	DESCRIPTION	UNIT
56100-04967	400 g	EA

C SCRUBBING BUBBLES® DISINFECTANT BATHROOM CLEANER

Foaming action cleans, shines, and deodorizes. No scrubbing needed. Use on tubs, showers, tiles, stainless, chrome and fixtures.



ORDER NUMBER	DESCRIPTION	UNIT
1 62913-73362	Aerosol	EA
2 62913-03234	Trigger	EA



D GLOBE™ TILE & GROUT BRUSH

Designed to clean tile grout and other hard to reach areas. Hard, stiff bristles for tough scrubbing and a durable soft grip handle. 9".

ORDER NUMBER	UNIT
4023	EA

F GLOBE™ TOILET BRUSH WITH CADDY

18" brush with soft grip holder. Resistant to stains, odors, bacteria, fungi, and wear. Ideal for commercial, medical, and industrial applications. Hole in the plastic handle allows for easy hanging. White.

ORDER NUMBER	UNIT
3452	EA



G SCOTCH-BRITE™ TOILET BOWL BRUSH WITH CADDY

Unique toilet brush with rim extension for cleaning under the rim. Caddy makes for easy, hidden storage. White.

ORDER NUMBER	UNIT
SB-TB	EA



NEW!

E CLOROX® DISINFECTING BIO STAIN & ODOUR REMOVER

Perfect for disinfecting and removing the toughest odors and stains in one step. This bleach-free stain and odor remover uses hydrogen peroxide technology to kill norovirus, E. coli, Salmonella and Hepatitis C that may be found in human and animal bio soils.



ORDER NUMBER	DESCRIPTION	UNIT
55500-01693	946 ml	EA

H GLOBE™ HYDROFORCE TOILET PLUNGER

Professional-grade plunger. Designed to get a better seal in the "throat" of the toilet.

Funnel can be retracted for use in flat sinks, wash basins and tubs. Includes 16" wooden handle. 5" high funnel.

ORDER NUMBER	UNIT
3455	EA



I SCOTCH-BRITE™ TOILET PLUNGER WITH CADDY

Ergonomic handle for easier and more controlled plunging. Caddy for hidden storage. White.

ORDER NUMBER	UNIT
SB-PLNGR	EA



CLEANING, BREAKROOM
AND FACILITIES

Check online for the most current price.

Cleaning Supplies – restroom cleaning

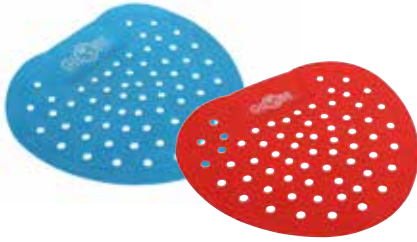

A GLOBE™ VINYL URINAL SCREENS

Eliminates odours for 30 days. Helps to prevent clogging. Flexible to fit all urinals.

ORDER NUMBER	DESCRIPTION	UNIT
1 3251B	Bubblegum	10/PK
2 3251R	Cherry	10/PK



B GLOBE™ URINAL SCREEN WITH NON-PARA DEODARANT BLOCK

Cleans and descales with every flush. Long lasting fragrance. Helps prevent debris from clogging pipes

ORDER NUMBER	DESCRIPTION	UNIT
1 3252	Screen with block, 12/PK Clean Breeze	
2 3253	Blue Cherry pucks 12/PK	

C DRANO® HAIR BUSTER GEL CLOG REMOVER

The hair formula is the toughest and most effective drano formula for hair clogs. Pours through standing water straight to the clog. Works in 15-30 minutes. 473 ml.



ORDER NUMBER	UNIT
59200-00203	EA



D 2000 FLUSHES® AUTOMATIC TOILET BOWL CLEANER

Bleaches away stains; phosphate free.

ORDER NUMBER	DESCRIPTION	UNIT
1 41737-90801	Blue Plus Bleach, 100 g	EA
2 41737-90102	Blue Plus Detergents, 100 g	EA
3 41737-90615	Chlorine, 35g	EA



E AVMOR® ECOPURE™ EP74™ BOWL, URINAL AND PORCELAIN CLEANER

Thick lotion clings to all vertical surfaces rendering cleaning fast and scrub-free. Fragrance and phosphate free. No VOC's or APE's.



ORDER NUMBER	DESCRIPTION	UNIT
101106931	946 mL	EA

CLEANING, BREAKROOM AND FACILITIES



F LYSOL® DISINFECTANT TOILET BOWL CLEANER

Thick formula that cleans, disinfects and deodorizes. The angled neck bottle targets hard to reach areas, including under the rim.

ORDER NUMBER	DESCRIPTION	UNIT
50814	946 ml	EA



G SCRUBBING BUBBLES® BUBBLY BLEACH GEL TOILET BOWL CLEANER

Foaming disinfecting bleach gel formula kills 99.9% of germs and bacteria. The unique neck offers better reach under the rim. 710ml.

ORDER NUMBER	DESCRIPTION	UNIT
1 62913-73541	Rainshower EA	
2 62913-73543	Citrus EA	



H SCRUBBING BUBBLES® EXTRA POWER TOILET BOWL CLEANER

Remove rust and destroy 100% of limescale with their most powerful stain-fighting formula ever. Changes from green to blue as it powers through stains. Rainshower. 710ml.

ORDER NUMBER	UNIT
62913-73542	EA

Cleaning Supplies – facial tissues



A KLEENEX® ON-THE-GO FACIAL TISSUE

Thick, durable, and absorbent on-the-go tissues. Be prepared for every little sniffle, sneeze, or little mess. FSC® Certified. Convenient small pack fits in pockets, purses, backpacks. 3-ply. 10 sheet packs. White.

ORDER NUMBER	UNIT
46651	8/PK



B WHITE SWAN™ FACIAL TISSUE

The right combination of softness and strength. 2-ply tissue; 100 sheets per box.

ORDER NUMBER	UNIT
08301	BX



C KLEENEX® ULTRA SOFT™ FACIAL TISSUE

Soft, strong, fragrance free. Dependable strength and ultimate softness. 3-ply. 70 sheets/box. White. 16 boxes/pkg.

ORDER NUMBER	UNIT
47324	16/PK



D KLEENEX® FACIAL TISSUE

Premium quality and softness, offering absorbency. Signal feature alerts you when it's time to change the box. FSC® Certified. Flat box. 2-ply. 100 sheets/box. White. 6 boxes/pkg.

ORDER NUMBER	UNIT
48742	6/PK



E KLEENEX® ANTI-VIRAL FACIAL TISSUES

Moisture-activated middle layer is scientifically proven to kill 99.9% of cold and flu viruses. 3-ply. 8 1/4" x 8 1/4". White. 55 sheets/box.

ORDER NUMBER	UNIT
54552	BX



F KLEENEX® FACIAL TISSUES

Signal® feature indicates when it's time for a new box. 2-ply. 100 sheets/box.

ORDER NUMBER	UNIT
21400	BX



G SCOTTIES® MULTI FACIAL TISSUES

Canada's #1 selling facial tissue. Hypoallergenic, dermatologist approved. 2-ply. 126 sheets/box.

ORDER NUMBER	UNIT
80136	6/PK



H WHITE SWAN™ FACIAL TISSUE

The right combination of softness and strength. 2-ply tissue; 100 sheets per box. 9 boxes per pack.

ORDER NUMBER	UNIT
10874	9/PK



I KLEENEX® SOOTHING LOTION™ FACIAL TISSUE

Infused with a touch of coconut oil, aloe and vitamin E, nourishes and protects skin by locking in moisture. Flat box. 3-ply. White.

ORDER NUMBER	DESCRIPTION	UNIT
1 54293	120 sheets/box	3/PK
2 54271	60 sheets/box	EA

CLEANING, BREAKROOM AND FACILITIES

Cleaning Supplies – bathroom tissue and dispensers

NEW!

A COTTONELLE® ULTRA CLEANCARE® TOILET PAPER

Designed with the right balance of strength and softness for an effective clean. Features CleaningRipples™ Texture for a superior clean. 1-ply. Mega Roll. 312 sheets per roll. White.



ORDER NUMBER	UNIT
1 54150	6/PK
2 54151	12/PK



B EMBASSY® BATHROOM TISSUE

Supreme quality, quilted embossed 2-ply bathroom tissue. The softest, strongest, and most absorbent option. Individually wrapped rolls. 418 sheets per roll.



ORDER NUMBER	UNIT
05490	48/CT

NEW!

D COTTONELLE® ULTRA COMFORTCARE® TOILET PAPER

Features CleaningRipples™ texture for a truly Superior Clean. 2-ply. Mega Roll. 268 sheets per roll. White.



ORDER NUMBER	UNIT
54167	6/PK



C PUREX® BATHROOM TISSUE

2-Ply 506 sheets per roll. White.



ORDER NUMBER	UNIT
05705	60/CT



E METRO BATHROOM TISSUE

2-Ply. 500 sheets per roll. Made with 100% recycled fibre. White.



ORDER NUMBER	UNIT
05485	48/CT

CLEANING, BREAKROOM
AND FACILITIES

F CASHMERE® DOUBLE ROLL QUILTED BATHROOM TISSUE

Soft meets strong. An earth-friendly product that is manufactured with materials that are septic safe. 242 2-ply sheets/roll.



ORDER NUMBER	UNIT
1 34272	12/PK
2 34254	24/PK



G WHITE SWAN® ECOLOGO™ BATHROOM TISSUE

Quilted and embossed. Two-ply. Made with 100% recycled fibre and at least 88% post-consumer content.



ORDER NUMBER	DESCRIPTION	UNIT
1 05965	500 sheets/roll	NEW! 96/CT
2 05144	429 sheets/roll	48/CT
3 10325	325 sheets/roll	36/PK

Cleaning Supplies – bathroom tissue and dispensers



A CHROME TISSUE DISPENSER

Chromed steel dispensers with hidden locking mechanism. Simply pinch the empty core to change the roll.

ORDER NUMBER	DESCRIPTION	UNIT
146	Single roll dispenser	EA



B KRUGER DESIGNER® JUMBO BATH TISSUE JR. DISPENSER

Dispenser for jumbo rolls. Smoke. 12.3"×20.8"×5"D.

ORDER NUMBER	UNIT
09645	EA



C CASCADES PRO® UNIVERSAL DOUBLE ROLL BATHROOM TISSUE DISPENSER

Perfect for any mid-size facility or office bathroom. Transparent cover always makes it clear to see when it's time to refill. Locking cover. 7½"W×7"D×12⅞"H. Grey.



ORDER NUMBER	UNIT
DB20	EA



D KRUGER NOIR MICRO-MAX+® TWIN BATHROOM TISSUE DISPENSER

Holds two small-core bathroom tissue rolls. Push button option for keyless opening. Horizontal. Smoke.

ORDER NUMBER	UNIT
09656	EA

E METRO JUMBO BATHROOM TISSUE

Provides proper hygiene with less maintenance. 2-ply 1000' white.



ORDER NUMBER	UNIT
05112	12/CT



F ESTEEM JUMBO BATHROOM TISSUE

Ideal for high traffic washrooms. Provides standard softness and absorbency. Contains a minimum of 88% recycled material. 2-ply 1000' white.



ORDER NUMBER	UNIT
05662	8/CT

G GLOBE™ SANITARY NAPKIN DISPOSAL

Prevents the spread of disease or cross-contamination. Can be used on the floor or mounted on the wall. Includes complimentary waxed bag. Plastic. 9"W×4½"D×10½"H. White.



ORDER NUMBER	DESCRIPTION	UNIT
1 3014	Receptacle	EA
SANITARY NAPKIN WAXED BAGS		
2 3015	Wax coating for moisture-resistance, 7½"×9½"	500/CT



H GLOBE™ TOILET SEAT COVERS

Half-fold toilet seat covers offer a convenient, economical, hygienic way to cover public toilet seats. 250/pack.

ORDER NUMBER	DESCRIPTION	UNIT
1 4610GCP	Seat covers	PK
2 4600	Half fold toilet seat cover dispenser	EA

Cleaning Supplies – paper towels and dispensers



NEW!



A BOUNTY SELECT-A-SIZE PAPER TOWELS

The original quicker picker-upper. You choose how much you need depending on the spill. Two-ply. 74 sheets per roll.

ORDER NUMBER	UNIT
37000-65538	12/PK



B WHITE SWAN® PAPER TOWELS

Superior quality paper, soft and absorbent. 80 sheets per roll. 2-ply white.

ORDER NUMBER	UNIT
01656	30/CT



NEW!



C WHITE SWAN® PROFESSIONAL TOWELS

2-ply. White.

ORDER NUMBER	UNIT
1 01890	90/RL
2 01122	210/RL



D SPONGE TOWELS® ULTRA CHOOSE-A-SIZE® PAPER TOWELS

A premium paper towel with Sponge Pockets technology that delivers ultra-absorbency. Two-ply. 72 sheets per roll. 6 rolls per pack.

ORDER NUMBER	UNIT
53606	6/PK



E DURAPLUS® KRAFT PAPER TOWEL ROLLS

Economical and eco-friendly choice to dry hands effectively and efficiently. 7 4/5" wide. Kraft.

ORDER NUMBER	DESCRIPTION	UNIT
1 57760352	205'	24/CT
2 57760355	350'	12/CT
3 57760359	800'	6/CT



F WHITE SWAN® ROLL TOWELS

Contains a minimum of 88% post-consumer recycled material. 8" wide. White.

ORDER NUMBER	DESCRIPTION	UNIT
1 01930	205'	24/CT
2 01600	500'	12/CT
3 01950	800'	6/CT

CLEANING, BREAKROOM AND FACILITIES



G EMBASSY® KITCHEN TOWEL POLY PACK

Convenient for smaller restaurants and quick service cafeterias, medical and dental clinics and offices. 2-ply. 10 1/2" x 10 1/2". 52 sheets/roll. White.

ORDER NUMBER	UNIT
10146	15/PK



H DURAPLUS® KRAFT PAPER TOWELS

Ideal for commercial and public restrooms. Delivers high quality and performance at excellent value. No added dyes or fragrances. 250 sheets per pack. 16 packages per carton. Kraft.

ORDER NUMBER	DESCRIPTION	UNIT
1 57760362	Singlefold	16 PK/CT
2 57760351	Multi Fold	16 PK/CT



I WHITE SWAN® FOLDED TOWELS

Contains a minimum of 88% post-consumer recycled material. White singlefold are 250 per pack. White multifold are 334 per pack.

ORDER NUMBER	DESCRIPTION	UNIT
1 01900	Singlefold	16 PK/CT
2 01920	Multifold	12 PK/CT



Cleaning Supplies – paper towels and dispensers



A ROYAL SOVEREIGN™ TOUCHLESS HAND DRYER

Help eliminate the spread of bacteria while saving on costly paper towels. Dries hands in under 20 seconds. Auto sensor turns on when hands are below the sensor and shuts off when hands are removed. 9¾"W×7½"D×5"H. 18-month limited warranty. Stainless Steel.

ORDER NUMBER	UNIT
RTHD-421S	EA



B NOIR TOUCHLESS MECHANICAL ROLL TOWEL DISPENSER

Touchless operation avoids spread of germs. Sleek, European design; ADA compliant. Can be used in HACCP-compliant environments. 13.6"×14.8"×9.4".

ORDER NUMBER	DESCRIPTION	UNIT
09740	Smoke/Black	EA

C ROYAL SOVEREIGN™ HIGH EFFICIENCY TOUCHLESS HAND DRYER

Dry faster than a traditional hand dryer. Provides added style and elegance. Ideal for use in medium and high use applications. Dries hands in under 15 seconds. Auto sensor turns on when hands are below the sensor and shuts off when hands are removed. Selectable heat on/off and high/low speed control. 9¾"W×7¾"D×12½"H. 5-year limited warranty, 3-year warranty on motor. Stainless Steel.

ORDER NUMBER	UNIT
RTHD-431SS	EA



D DESIGNER® PUSH BAR ROLL TOWEL DISPENSER

Large capacity; designed for long towel rolls. Easy to load; automatic stub roll feature. 15.75"×10.5"×8.75".

ORDER NUMBER	DESCRIPTION	UNIT
09772	Black	EA



E NOIR FOLDED TOWEL DISPENSER

Dispenses singlefold, multifold and c-fold towels. 10²⁵/₃₂"W×4³/₁₆"D×14²³/₃₂"H.

ORDER NUMBER	DESCRIPTION	UNIT
09110	Smoke/Black	EA



F FROST UNIVERSAL TOWEL DISPENSER

With cutting bar. Can be used for roll towels or single fold paper towels. 10.5"×6.75"×9.5".

ORDER NUMBER	DESCRIPTION	UNIT
1 101	Epoxy powder finish, White	EA
2 103	Stainless Steel finish, Brushed Silver	EA

G NOIR CENTRE PULL TOWEL DISPENSER

Controlled dispensing with an adjustable nozzle. Metro two-ply centre pull towels, 8"×600". 9½"W×10¼"D×12¼"H.

ORDER NUMBER	DESCRIPTION	UNIT
1 09410	Dispenser	EA
2 01322	White towels	6/CT



Cleaning Supplies – laundry supplies

NEW!



A TIDE® HE LAUNDRY PODS™

Fights stains & brightens in one step. No pouring, no spills - just toss one in. Dissolves quickly in front and top load machines. Spring Meadow.

ORDER NUMBER	DESCRIPTION	UNIT
37000-91781	81/tub	PK

B TIDE® HE LAUNDRY LIQUID

Excellent cleaning. Low-sudsing formula for high efficiency washers. Disperses quickly - great cleaning performance with a fraction of the water used in traditional machines. Fights tough odours. Original. 2.72 L. 64 loads.



ORDER NUMBER	UNIT
37000-40217	EA



E MRS. MEYER'S® CLEAN DAY LAUNDRY

The detergent packs a punch when removing dirt and stains. Fabric softener and dryer sheets contains softening ingredients from plant-derived sources.

ORDER NUMBER	DESCRIPTION	UNIT
--------------	-------------	------

LEMON VERBENA

1	59200-70850	Detergent	EA
2	59200-00120	Fabric Softener	EA
3	59200-70851	Dryer Sheets	80/BX

LAVENDER

4	59200-70862	Detergent	EA
5	59200-00121	Fabric Softener	EA
6	59200-70861	Dryer Sheets	80/BX



C PUREX® AFTER THE RAIN® 4-IN-1 PACS™

No mess, just toss and go! 4-in-1 laundry packs for HE machines. After the Rain®.

ORDER NUMBER	UNIT
1 24200-00355	23/PK
2 24200-05130	NEW! 80/PK

D PUREX® COLDWATER LIQUID LAUNDRY DETERGENT

Protect colours from fading so clothes last longer. Alpine Fresh. 1.47 L.



ORDER NUMBER	UNIT
24200-09138	EA

F BOUNCE® DRYER SHEETS

Fabric softener sheets ideal for softening clothes, controlling static, and repelling pet hair and lint. Time-release technology makes it last up to 30 days. Outdoor Fresh. 200 sheets/box.



ORDER NUMBER	UNIT
37000-30420	BX



G SNUGGLE® DRYER SHEETS

Up to 30 days of freshness. Cuddle-Up Fresh®.

ORDER NUMBER	UNIT
1 72613-45429	120/BX
2 72613-17131	NEW! 200/BX

H SHOUT® TRIPLE-ACTING STAIN REMOVER

Packed with stain-fighting ingredients and enzymes to quickly penetrate, break up and remove tough stains. Convenient trigger spray. 650 ml.



ORDER NUMBER	UNIT
62300-00807	EA

I SCOTCH-BRITE™ 50% STICKIER LINT ROLLER

Keep clothes free from crumbs, fuzz and hair with 50% more adhesive. Perforated sheets tear off cleanly. New ergonomic handle for quick and efficient cleaning. 48 sheets per roller.



ORDER NUMBER	UNIT
830RS-48-CA	EA

J CLOROX® BLEACH

Provides unbeatable whitening for fabrics while removing body soil, stains and odours. 2.4 L.



ORDER NUMBER	UNIT
55500-01731	EA

K FEBREZE® FABRIC REFRESHER

Eliminates 99.9% of odour causing bacteria on fabrics. Light, fresh scent. 800 ml.



ORDER NUMBER	DESCRIPTION	UNIT
37000-35218	Antibacterial	EA

CLEANING, BREAKROOM AND FACILITIES

Cleaning Supplies – dusters



A SWIFFER® 360° DUSTERS™

Thousands of deep-cleaning fibers help reduce allergens. Designed specifically to clean dirt in grooves and crevices, it traps and locks dust and allergens better than a feather duster. All-around design features 50% more fibers than regular Swiffer Dusters.

ORDER NUMBER	UNIT
37000-16944	6/BX



B SWIFFER® 360° DUSTERS™ EXTENDER™ KIT

Extends handle up to 3 feet; pivots for hard to reach cleaning. Locks into four different positions. Includes handle and 3 disposable dusters.

ORDER NUMBER	UNIT
37000-44750	EA



C SWIFFER® 180° DUSTERS™

Picks up dust and locks it away. Lightly coated with DustLock adhesive, these fibres change shape to reach into nooks and crannies. Traps twice as much dirt as regular cloths.

ORDER NUMBER	DESCRIPTION	UNIT
1 37000-40509	180° Dusters kit	EA
2 37000-41767	Refills, unscented 10/BX	



D CHICOPEE® STRETCH'N DUST® DUSTER

Medium weight duster for surface and floor dusting. Excellent for toner and small particle pick-up. Towels are soft enough for delicate surfaces, low linting and will not leave behind hazardous residue. 12" x 17". Yellow.

ORDER NUMBER	UNIT
0413	40/PK



E GLOBE™ CHENILLE MICROFIBER DUSTER

Stainless steel sword embedded in heavy canvas can be bent into almost any shape. Perfect for high dusting. The washable chenille has soft dust grabbing fingers.

ORDER NUMBER	UNIT
4030	EA



F GLOBE® MICROFIBRE DUSTER

Capture and lock in dust for fast, efficient cleaning. Ideal for cleaning cars, office areas, computers, TVs, room corners, kitchen cabinets, electronic equipment, sofas, ceiling corners and more. Hanging cap for easy storage. Will not scratch surfaces. Attracts dust like a magnet. White.

ORDER NUMBER	DESCRIPTION	UNIT
1 4038	28" handle	EA
2 4039	33" handle	EA



G PLEDGE® MULTI-SURFACE CLEANER DISINFECTANT

Cleans and disinfects. Pleasant citrus scent. Use on sealed wood laminate, glass, mirrors, stainless steel, plastics, chrome and electronics.

ORDER NUMBER	UNIT
62300-70688	EA



H PLEDGE® BEAUTIFY LEMON FURNITURE POLISH

Improves the appearance of most hard surfaces by removing dust and fingerprints and providing a protective, glossy coating without leaving a waxy buildup. Safe to use only on finished, sealed surfaces. 403g.

ORDER NUMBER	UNIT
46500-00258	EA

NEW!

I PLEDGE® PH BALANCE MULTI-SURFACE CLEANER

Works on most hard, non-porous surfaces such as chrome, electronics, glass, laminate, plastic, sealed granite, sealed marble, sealed quartz, sealed wood, stainless steel and more. Fresh Citrus.

ORDER NUMBER	DESCRIPTION	UNIT
62300-00794	750 ml	EA



CLEANING, BREAKROOM AND FACILITIES

Cleaning Supplies – brooms and mops



A RUBBERMAID® HYGEN™ WET/DRY MOP SYSTEM

Flat profile slides easily under furniture and equipment. Lightweight aluminum.

ORDER NUMBER	DESCRIPTION	UNIT
QUICK-CONNECT HANDLE		
One-step connecting mechanism speeds mop assembly and changeover. User-friendly grip makes handle more comfortable.		
1	FGQ75000YL00 58" H	EA
QUICK CONNECT WET/DRY FRAME		
Replaceable hook-and-loop strips extend product life.		
2	FGQ56000YL00 18" L	EA
DUST MOP WITH FRINGE		
3	FGQ41800GR00 18", Green	EA
4	FGQ43800GR00 36", Green	EA
FLOOR PAD		
5	FGQ41000BL00 18"L, Blue	EA



B SWIFFER® SWEEPER STARTER KIT

Attracts and traps dirt and dust from virtually any floor and surface. Use the dry cloth to trap and lock dirt, dust and hair. Use the wet cloth to dissolve dirt and grime. Kit comes with sweeper, 7 dry sweeping cloths and 3 wet mopping cloth.

ORDER NUMBER	DESCRIPTION	UNIT
1	37000-92815 Sweeper kit	EA
DRY CLOTH REFILLS		
2	37000-33407	32/BX
WET CLOTH REFILLS		
3	37000-35154 Open Window Fresh	12/BX
4	37000-35155 Open Window Fresh	24/BX



D GLOBE™ TIE-ON COTTON DUST MOP

Absorbent and economical. 4-ply high-quality cotton yarn that is sewn onto a durable polyseter backing.

ORDER NUMBER	DESCRIPTION	UNIT
1	3551 24"×5"	EA
2	3552 36"×5"	EA
GLOBE™ DUST MOP METAL HANDLE WITH SNAP ON CLIP		
Snaps on to all frame sizes. Durable heavy-duty gage steel. Unique sliding pin that ensures quick, easy connection with frame. Peg hole at top for easy hanging storage.		
3	3108 60"	EA
GLOBE™ SNAP ON MOP FRAME		
Durable construction with smooth finish to reduce snags on the mop.		
4	3105 24"×5"	EA
5	3106 36"×5"	EA



C GLOBE™ PUSH BROOM

Durable hardwood block and polypropylene bristles that are both chemical and water resistant. The handle, sold separately, is lacquered wood with a threaded metal tip.

ORDER NUMBER	DESCRIPTION	UNIT
1	4453 24" Medium, Indoor/Outdoor	EA
2	4455 24" Stiff, Outdoor - Ideal for larger debris	EA
3	4075 1 1/2"×54", handle	EA

E COMMAND™ BROOM GRIPPER

Forget about nails, screws and tacks. Revolutionary Command™ Adhesive holds strongly on a variety of surfaces. Removes cleanly - no holds, marks, sticky residue or stains. 4 lb capacity.



ORDER NUMBER	UNIT
17007-EF	EA

Cleaning Supplies – brooms and mops



A GLOBE™ ANGLE BROOMS

Angled bristles to reach into corners. Removable 48" metal handle.

ORDER NUMBER	DESCRIPTION	UNIT
1 4010	8"	EA
2 4012	11"	EA

THE BEAST HEAVY DUTY

For outdoor use.

3 4006	13 1/2"	EA
--------	---------	----



E GLOBE™ LOBBY ANGLED BROOM

Angled bristles to reach into corners. Perfect handle height for one-handed use. Split tip fiber removes dirt and dust effectively. Removable handle to create a whisk.

ORDER NUMBER	UNIT
1 3032	EA

GLOBE™ UPRIGHT LOBBY DUSTPAN

Strong and quiet hinge pin design. Built-in handle on back to let you empty without touching the pan. Ergonomic handle for reduced wrist strain.

2 3031	EA
--------	----



B GLOBE™ CLIP-ON DUSTPAN & BRUSH SET

Soft filaments with bonded rubber strip. Brush clips onto dustpan for easy storage with a hole for easy hanging. 9 1/2".

ORDER NUMBER	UNIT
1946	EA



C GLOBE™ PLASTIC DUST PAN

Commercial grade plastic that holds ample debris. Sharp edge makes it easy to collect fine particles without leaving dirt on the floor. 12".

ORDER NUMBER	UNIT
3005	EA



D GLOBE™ CLIP-ON DUSTPAN

Rubber edge allows easy collection of dirt and debris. Large mouth opening for quick and easy clean up. Dustpan snaps on the broom handle for easy storage.

ORDER NUMBER	DESCRIPTION	UNIT
1 4312	15"	EA

METAL DUSTPAN

Equipped with hang-up handle and a fine line edge to allow for maximum pick up.

2 4088	16"	EA
--------	-----	----



F GLOBE™ EZ GRABBER

Eliminate bending to pick up litter. Aluminum shaft with durable pistol grip. Rubber grips pick up objects as wide as 4 1/4" and as heavy as 2 lbs.

ORDER NUMBER	DESCRIPTION	UNIT
1 4972	30"	EA

GLOBE™ LITTER SCOOP WITH BAG

Perfect for large cleanup jobs outdoors. Minimizes back strain. Metal frame and base with ergonomic handle and vinyl bag.

2 3712	EA
--------	----



G DUSTBANE SWEEPING COMPOUND

Cleans and reduces airborne dust during sweeping. Eases the removal of dust and dirt on sealed and unsealed wood, concrete and metal floors. 22 kg.

ORDER NUMBER	UNIT
52509	EA

Cleaning Supplies – brooms and mops



A RUBBERMAID® WET MOP HANDLE AND FRAME

Makes removing and replacing mop heads easy and efficient. Thumb wheel clamps the mop firmly in place. Wooden handle with steel head. 1 1/2" diameter. 54".

ORDER NUMBER	UNIT
FGH516000000	EA



C RUBBERMAID INVADER® SIDE-GATE MOP HANDLE

Makes removing and replacing mop heads easy and efficient. Thumb wheel clamps the mop firmly in place. Accommodates 1" head band mops. Fiberglass handle. 54".

ORDER NUMBER	UNIT
FGH145000000	EA



E GLOBE™ QUICK RELEASE METAL MOP HANDLE

Change mop heads in mere seconds by clamping the mop head into place. Heavy-Duty Steel gage handle. 54".

ORDER NUMBER	UNIT
3122	EA



G GLOBE® FLOOR AND DECK SCRUB BRUSH

Ideal for cleaning tile, linoleum, wood or cement. 48" metal handle with hang-up cap and stiff PET bristles.

ORDER NUMBER	UNIT
4019	EA

B GLOBE™ SYN-PRO® LOOP END MOP

Made from Anti-Shrink synthetic blended yarns that can withstand repeated launderings. Looped ends to maximize the mopping area and prevent mop from fraying. Individually bagged. Blue tailband prevents yarn from tangling and is highly resistant to chemicals and disinfectants.



ORDER NUMBER	DESCRIPTION	UNIT
1 3091	20 oz	EA
2 3092	24 oz	EA

D GLOBE™ SYN-PRO® CUT END MOP

Made from a high-quality synthetic yarn blend with excellent absorbency and release characteristics. Not launderable. Individually bagged. Reinforced stitching in band – 4 lines of Quad Core stitching for maximum strength.



ORDER NUMBER	DESCRIPTION	UNIT
1 3087	20 oz	EA
2 3088	24 oz	EA

F RUBBERMAID® COTTON MOP HEADS

Economical, cut-end mop head. 1" head band. White.



ORDER NUMBER	DESCRIPTION	UNIT
1 FGV11700WH00	20 oz	EA
2 FGV11800WH00	24 oz	EA



H GLOBE™ YACHT MOP

Made from anti-shrink synthetic blended yarns. Securely fastened to a metal handle. 54".

ORDER NUMBER	DESCRIPTION	UNIT
4016	12 oz	EA

Cleaning Supplies – brooms, mops and buckets



A RUBBERMAID® REVEAL™ SPRAY MOP

Safe to use on all floor types. Microfibre cleaning pad picks up 50% more dirt and dust. Refillable bottle allows you to mix your own solution. Non-scratch scrubber for stubborn spots. Non-battery operated spray trigger. Microfibre pads are reusable and machine washable.

ORDER NUMBER	UNIT
1 1782331	EA
REPLACEMENT PAD	
2 1777203	EA



B SWIFFER® WETJET® STARTER KIT

Cleans better, with less effort than conventional mop systems. Includes: Power Mop, disposable cleaning pads, scrubbing strip and a 500 ml bottle of multi-purpose cleaner.

ORDER NUMBER	DESCRIPTION	UNIT
1 37000-92811	Starter kit	EA
2 37000-08443	SWIFFER® WETJET® REFILL PADS	24/BX
1.25L REFILL		
3 37000-23679	Multipurpose	EA
4 37000-24334	Antibacterial	EA



C GLOBE™ BUCKET WITH WRINGER

12.3 L. 11½"W×15"D×11"H. Blue.

ORDER NUMBER	UNIT	
2060	EA	\$16.79



D RUBBERMAID® BRUTE® UTILITY BUCKET

Heavy duty, thick walled construction. Built-in pour spout and molded-in gradations for accurate measuring. Round. Grey. 9.5 L, 10½"Dia×10¼"H.

ORDER NUMBER	UNIT
FG296300GRAY	EA



E GLOBE™ SIDEPRESS BUCKET AND WRINGER

Easy one-handed transport. When space is an issue this bucket and wringer is the answer. 19.8 L. 26"W×11"D×26"H. Yellow.

ORDER NUMBER	UNIT
3082	EA



F RUBBERMAID® WAVEBRAKE® MOPPING SYSTEM

Tested to exceed 200,000 wringing cycles. Lasts 58X longer than comparative wringers. High back. Accommodates 12 to 32 oz mop heads. 3" grey nonmarking casters. Premium tubular steel and structural web-molded plastic. 33.1 L. Yellow.

ORDER NUMBER	DESCRIPTION	UNIT
FG757788YEL	Down press	EA



G GLOBE™ SIDEPRESS BUCKET AND WRINGER

Wringer has clip to hold mop handle in place. Smooth surface for easy cleaning. Covered spring to prevent injuries. 33.12 L. 21"W x 16"D x 34-1/2"H. Yellow.

ORDER NUMBER	UNIT
3080	EA

Cleaning Supplies – cleaning carts and signs



A GLOBE™ CLOSED FOR CLEANING SIGN

Soft, pliable sign for ease of use and storage. Lock pole to door frame and then tighten with one hand for extra torsion. 15"W×41"D×2"H. Bilingual.

ORDER NUMBER	UNIT
7115	EA



B GLOBE™ SAFETY CONE

Improve safety of patrons and employees. Reduce slip and fall accidents in your facility. 10½"W×10½"D×26"H. Bilingual.

ORDER NUMBER	UNIT
7200	EA



C GLOBE™ WET FLOOR SIGN

Folding design for convenient storage or transport. 12"W×17"D×33"H. Bilingual.

ORDER NUMBER	UNIT
7112	EA



D PINE-SOL® SURFACE CLEANER

Disinfects, deodorizes and degreases. Best used on hard, nonporous surfaces. Biodegradable and phosphate-free. Pine. 4.25 L

ORDER NUMBER	UNIT
55500-01166	EA



E RUBBERMAID® JANITOR CART BAG

Easy-to-clean smooth vinyl surface. 6 grommets allow bag to fit most janitorial carts. Zippered front allows easy ergonomic access to waste to make emptying easier. 24 gal. bag capacity. Yellow.

ORDER NUMBER	UNIT
1966719	EA



F RUBBERMAID® DELUXE CARRY CADDY

All purpose caddy for carrying tools and cleaning supplies. Fits on cleaning and housekeeping carts. Securely holds up to eight 32 oz spray bottles and other common cleaning tools. Ergonomic handle design provides comfortable fit. 15"W×11"D×7½"H.

ORDER NUMBER	UNIT
FG315488BLA	EA



G SPIC AND SPAN® FLOOR AND MULTI-SURFACE CLEANER

Versatile multipurpose cleaner cuts tough grease. For floors, walls, food-contact surfaces and restrooms.

ORDER NUMBER	UNIT
37000-02001	3.78 L EA



H MR. CLEAN® PROFESSIONAL FLOOR CLEANER

Excellent cleaning and shine preservation for finished floors including ceramic, vinyl and varnished hardwood.

ORDER NUMBER	UNIT
30772-03287	3.78 L EA



I RUBBERMAID® UTILITY CART

Perfect for transporting equipment and heavy loads. Sturdy foam construction won't rust, dent, chip or peel. Round corners. Lightweight and maneuverable. Large, non-marking casters. Ready to assemble. 500 lb capacity. 17¾"W×39"D×33¼"H. Black.

ORDER NUMBER	UNIT
FG450088BLA	EA



J GLOBE™ UTILITY CART

Ideal for an office, restaurant, healthcare facility or hotel. Strong sturdy handles and 4" rubber casters. Accommodates up to 200 lbs. 17"W×33"D×37"H. Black.

ORDER NUMBER	UNIT
5001GCP	EA



K RUBBERMAID® JANITOR CART WITH BAG

Smooth, easy-to-clean surface. Zippered yellow vinyl bag. Non-marking 8" wheels and 4" casters. Ready to assemble. 5 cu. ft. storage capacity, 34 gal. bag capacity. 46"W×21¾"D×38"H. Black.

ORDER NUMBER	UNIT
FG617388BLA	EA

Cleaning Supplies – carpet cleaning

NEW!



A BISSELL® CLEANVIEW® 2.0 UPRIGHT VACUUM

Powerful lightweight multi-surface upright vacuum with easy maneuverability. OnePass™ and Scatter-Free Technology allows you to clean carpets on the first pass, and clean debris from hard surfaces with less scatter. Active Extension Wand and TurboBrush® Tool enable you to reach any mess with ease. Easy Empty™ Dirt Tank straight into the trash with just the push of a button. Its washable filters and multi-level filtration system keep the CleanView® vacuum running like new.

ORDER NUMBER	UNIT
3536C	EA



B SANITAIRE DURALIGHT™ COMMERCIAL UPRIGHT VACUUM

Lightweight designed for heavy-duty use. CRI Green Label certified to provide premium filtration for cleaner indoor air. Disposable dust bag system. 13" cleaning path.

ORDER NUMBER	UNIT
SC9050D	EA

NEW!



C AURORA TOOLS® WET/DRY VACUUM

Features 16' power cord, strong top handle, swiveling casters, rear blower port, 6 peak HP motor, and 100 CFM air flow.. Includes: 1-7/8"x6' hose, two extension wands, crevice nozzle, utility nozzle, floor nozzle, cartridge filter, dust bag. 30.3 L tank. Black/Red.

ORDER NUMBER	UNIT
EB299	EA

D BISSELL® PERFECT SWEEP® TURBO RECHARGEABLE SWEEPER

Cordless. Up to 60 minutes of cleaning time. Easy-to-remove top loading dirt container, edge brushes for cleaning along baseboards and in corners. Charge indicator light. 12".



ORDER NUMBER	UNIT
2880F	EA



E BISSELL® POWERCLEAN® MULTI-CYCLONIC CANISTER VACUUM CLEANER

Powerful 15X Multi-Cyclone technology. Compact, lightweight, easy to carry. Multi-level filtration helps reduce allergens. Bottom empty dirt bin. Extended reach for cleaning baseboards and curtains. Motorized foot for vacuuming carpet. 12" sweeping path. 2-year warranty.

ORDER NUMBER	UNIT
1654C	EA



F BISSELL® STURDY SWEEP™ MANUAL SWEEPER

Corner brushes for cleaning in corners and along edges. Comfortable rubber grip. Safe on carpet, rugs and hard floors. Perfect for in-between cleanings Dual easy-empty dirt bins. 9¼" sweeping path.

ORDER NUMBER	UNIT
2483C	EA

CLEANING, BREAKROOM AND FACILITIES

Check online for the most current price.

Cleaning Supplies – carpet cleaning



A BISSELL® POWERCLEAN® PET LITHIUM ION CORDLESS HAND VAC

Remove more embedded dirt and pet hair with the motorized brush tool and lithium ion battery. 12V max and 12 minutes of run time. Features triple level filtration and a large, easy-to-empty dirt bin. Includes a motorized brush tool, upholstery tool and a crevice tool. 1 year limited warranty.

ORDER NUMBER	UNIT
2389D	EA



B BISSELL® SPOTCLEAN™ PROFESSIONAL PORTABLE DEEP CLEANING SYSTEM

Designed to easily clean carpet, upholstery, stairs, area rugs, auto interiors, and more. Removable water tanks for easy filling and emptying. Includes a 3" tough stain tool, 3-in-1 Stair Tool and trial sample size Professional Deep Cleaning Formula. 3/4 gallon tank capacity.

ORDER NUMBER	UNIT
3624C	EA



C GLADE® CARPET & ROOM ODOUR ELIMINATOR

Eliminates deep-down odours. Gets rid of smoke, mold and mildew odours. 907 g.

ORDER NUMBER	UNIT
62300-00248	EA

D FEBREZE® FABRIC REFRESHER

Eliminates 99.9% of odour causing bacteria on fabrics. Light, fresh scent. 800 ml.

ORDER NUMBER	DESCRIPTION	UNIT
37000-35218	Antibacterial	EA



E BISSELL® CARPET CLEANING FORMULA

For full size machines. Contains Scotchgard™ to help protect carpet from future stains. 1.41 L

ORDER NUMBER	UNIT
78H6Y	EA



F SPOT SHOT® INSTANT CARPET STAIN & ODOUR ELIMINATOR

Certified biodegradable. Trigger spray bottle. 650 ml.

ORDER NUMBER	UNIT
74405-00914	EA



G EMZONE CARPET & UPHOLSTERY FOAM CLEANER

Formulated for quick and easy cleaning of carpet, fabric, vinyl and leather surfaces. Dry foam gently lifts and cleans without saturating or leaving residue. 500 g / 18 oz.

ORDER NUMBER	UNIT
60480-44016	EA



H SCOTCHGARD® FABRIC & UPHOLSTERY PROTECTOR

Helps to block stains so they release with a gentle wash. Won't change the look, feel or breathability of most fabrics when applied as directed. 283g.

ORDER NUMBER	UNIT
4106-10-6CA	EA



TruSens™

PERFORMANCE SERIES AIR PURIFIERS



©2022 ACCO Brands. All Rights Reserved. C129_22_P



MORE POWER
WHERE YOU NEED IT



REDUCES
AIRBORNE VIRUS EXPOSURE



SAVE
WHERE IT COUNTS

- Complete room coverage up to 2,000 sq. ft.*
- Enhanced SensorPod™ with real-time feedback
- 4 levels of protection including True HEPA filtration
- No installation required

*AHAM uses 4.84 air changes per hour, so AHAM values are slightly different.

Air Care – air purifiers



A TRUSENS™ AIR PURIFIER

PureDirect technology distributes air more comfortably and effectively. 360 degree DuPont™ HEPA filter captures pollutants and VOC gases and odours from all directions. UV light kills germs and bacteria that can get trapped in the filter. Touch-button control of fan speed, UV mode, and filter replacement indicators. Carbon, HEPA and UV filters.

ORDER NUMBER	DESCRIPTION	UNIT
Z1000AP	Covers 250 sq.ft., EA	65dB

B TRUSENS™ AIR PURIFIERS

Say goodbye to dust, pollen and other allergens. Place the remote SensorPod away from the air purifier to optimize clean air delivery. A colour-coded illuminated ring and numerical value communicates good, moderate or poor air quality. Carbon, HEPA and UV filters. Auto and dimmer mode. Timer settings of 2, 4, 8, or 12 hours. Filter change indicator type.

ORDER NUMBER	DESCRIPTION	UNIT
1 Z2000AP	Covers 375 sq.ft., EA	33-64 dB
2 Z3000AP	Covers 750 sq.ft., EA	33-64 dB NEW!

C TRUSENS™ SMART AIR PURIFIERS

SensorPod detects smaller particles that can be inhaled and get into your lungs and bloodstream as well as smoke, certain VOCs and odour. With the TruSens App, track your AQI (Air Quality Index) history, set up schedule, get replacement reminders. Carbon, HEPA and UV filters. Auto and Night mode. Timer settings of 2, 4, 8, or 12 hours.

ORDER NUMBER	DESCRIPTION	UNIT
1 Z2500AP	Covers 375 sq.ft., EA	33-64 dB
2 Z3500AP	Covers 750 sq.ft., EA	33-60 dB



NEW!

D TRUSENS™ PERFORMANCE SERIES AIR PURIFIERS

Professional Air Purification with dual True HEPA, TRU-BEAM™ UV-C light, Activated Carbon plus SensorPod™ and AQI monitor. Captures and destroys viruses, bacteria, and VOCs. Low cost-to-performance ratio. Carbon, dual HEPA, and UV filters. Auto mode. Timer settings of 2, 4, 8, or 12 hours.

ORDER NUMBER	DESCRIPTION	UNIT
1 Z6000AP	Covers 1750 sq.ft., 33-63 dB	EA
2 Z7000AP	Covers 2000 sq.ft., 30-66 dB	EA



E DUPONT™ TRUSENS™ REPLACEMENT FILTERS

ORDER NUMBER	DESCRIPTION	UNIT
--------------	-------------	------

CARBON FILTERS

1 AFCZ1000-01	for Z1000AP	3/PK
2 AFCZ2000-01	for Z2000AP/Z2500AP	3/PK
3 AFCZ3000-01	for Z3000AP/Z3500AP	3/PK

ALLERGY & FLU CARBON FILTER **NEW!**

4 AFCZ1000-AGY01	for Z1000AP	EA
5 AFCZ2000-AGY01	for Z2000AP/Z2500AP	EA
6 AFCZ3000-AGY01	for Z3000AP/Z3500AP	EA

ORDER NUMBER	DESCRIPTION	UNIT
--------------	-------------	------

TRUE HEPA DRUM FILTER

7 AFHZ1000-01	2-in-1 for Z1000AP	EA
8 AFHZ2000-01	3-in-1 for Z2000AP/Z2500AP	EA
9 AFHZ3000-01	3-in-1 for Z3000AP/Z3500AP	EA

TRUE HEPA ALLERGY & FLU DRUM FILTER **NEW!**

10 AFHZ1000-AGY01	for Z1000AP	EA
11 AFHZ2000-AGY01	for Z2000AP/Z2500AP	EA
12 AFHZ3000-AGY01	for Z3000AP/Z3500AP	EA

Fellowes
AIR PURIFIERS



THE MOST PREPARED WORKPLACES HAVE FELLOWES

Keep your occupants safe and provide peace of mind.

Public and shared spaces can be breeding grounds for air pollutants like viruses, bacteria, dust, allergens, odours, and harsh chemicals. Any of these contaminants could have a negative impact on the health of your facility's occupants.

Whether you are welcoming employees, guests, patients or patrons, you can provide maximum protection by making your facility safer and healthier - with AeraMax Pro air purifiers from Fellowes.



Discover clean air solutions at [fellowes.com/air](https://www.fellowes.com/air)

Air Care – air purifiers and humidifiers

A FELLOWES® AIR PURIFIERS WITH AERASMA™ SENSORS

AeraSmart™ Sensor monitors the air quality and automatically adjusts the fan speed to keep your air purified. True HEPA filter with AeraSafe™ antimicrobial treatment safely removes 99.97% of airborne particles as small as 0.3 microns, including pollen, ragweed and other allergens, viruses, germs, dust mites, mold spores and cigarette smoke. Ultra quiet operation. Filter Change Indicators let you know when it is time to replace your Carbon or True HEPA filter.



ORDER NUMBER	DESCRIPTION	UNIT
AERAMAX® 90 AIR PURIFIER Effectively purifies air in a 100-200 square foot room		
1 9286001		EA
2 9287004	True HEPA filter with AeraSafe™ Antimicrobial Treatment	EA
3 9324004	Carbon replacement filter	4/PK
AERAMAX® 190 AIR PURIFIER Effectively purifies air in a 200-400 square foot room		
4 9286101		EA
5 9287104	True HEPA filter with AeraSafe™ Antimicrobial Treatment	EA
6 9324104	Carbon replacement filter	4/PK
AERAMAX® 290 AIR PURIFIER Effectively purifies air in a 300-600 square foot room		
7 9286201		EA
8 9287204	True HEPA filter with AeraSafe™ Antimicrobial Treatment	EA
9 9324204	Carbon replacement filter	4/PK



AeraMax Pro AM3 and AM4 air purifiers demonstrated, through independent laboratory testing, to be effective in eliminating aerosolized concentration of SARS-CoV-2 by 99.9999% through a single air pass test of the purifier. In addition, AeraMax Pro air purifiers reached 99.99% airborne reduction of a surrogate Human Coronavirus 229E in a 20m3 test chamber within 1 hour of operation in a separate test.



B FELLOWES® AERAMAX® PROFESSIONAL AIR PURIFIERS

Four stage True HEPA filtration removes at least 99.97% of particles as small as 0.3 microns including allergens, pollen, dust, pet dander and smoke. Antimicrobial HEPA treatment applied to the True HEPA filter inhibits the growth of odour and stain-causing microorganisms. Monitor occupancy and air quality using EnviroSmart™ Technology. EnviroSmart™ Technology continuously monitors your environment and automatically adjust to clear the air. Stainless Steel.

ORDER NUMBER	DESCRIPTION	UNIT
AM 2 3 fan speeds, 3-year warranty. 14.19×4.13×22.63		
1 9416101	Covers 150 - 250 square feet	EA
AM 3 5 fan speeds, 5-year warranty. PlasmaTrue™ Technology creates an ionized field to help safely remove airborne pollutants. 21.06×9.5×19.50		
2 9416201	Covers 300 - 550 square feet	EA
AM 4 5 fan speeds, 5-year warranty. EnviroSmart™ Technology continuously monitors your environment and automatically adjust to clear the air. 34.81×9.5×19.5		
3 9416301	Covers 650 - 1,100 square feet	EA
AM 3 PC 5 fan speeds, 5-year warranty. EnviroSmart™ Technology continuously monitors your environment and automatically adjust to clear the air. PureView™ Technology show the percentage of particles captured and a live status of room air quality. 21×9.5×19.5		
4 9573001	Covers 300 - 550 square feet	EA
AM 4 PC 5 fan speeds, 5-year warranty. EnviroSmart™ Technology continuously monitors your environment and automatically adjust to clear the air. PureView™ Technology show the percentage of particles captured and a live status of room air quality, 37×9.5×19.5		
5 9573101	Covers 650 - 1,100 square feet	EA

C TRUSENS™ ULTRASONIC HUMIDIFIERS

Remote SensorPod™ humidity monitor and control with TruSens water softening filter to reduce white dust. Remote control feature to control power (on/off), misting speed, and dimmer (on/off). High tank capacity, quiet operation and night mode, aromatherapy tray and carry handle. Timer Settings: 2h/4h/8h/12h. White.

ORDER NUMBER	DESCRIPTION	UNIT
Features cool mist, 50 hour operating time, 3-year limited warranty. 39.3 dB		
1 N200H	Medium, 5L water tank	EA
Features UV-C light helps kill bacteria in the mist, capacitive touch control panel, variable warm and cool mist settings, 80 hour operating time, 41.0 dB, 3-year limited warranty		
2 N300H	Large, 8L water tank	EA
TRUSENS™ AROMATHERAPY PADS FOR TRUSENS™ ULTRASONIC HUMIDIFIERS		
Relax to soothing scents of essentials oils while humidifying. Add a few drops of essential oil to aromatherapy pad and place in the back tray of humidifier. Compatible with TruSens humidifier models N-200 and N-300. 50mm×3mm.		
3 ATP300-01	Aromatherapy Pads	10/PK
TRUSENS™ ULTRASONIC HUMIDIFIER REPLACEMENT FILTER		
Keeps TruSens Humidifier running at optimal levels. The enhanced water softening filter minimizes mineral build up and white dust for a cleaner mist. Lasts approximately 4 months. Compatible with TruSens humidifier models N-200 and N-300, 2½"×2½"×5½". White.		
4 WSF300-01	Replacement filter	EA

Air Care – air fresheners



A GLOBE™ AIR-PRO METERED SPRAY DISPENSER

Programmable in 3 modes: 24-Hour, Day, or Night and intervals of every 7½ minutes, 15 minutes or 30 minutes. Universal for compatibility with most aerosol freshener refills in the market. Requires 2 "AA" batteries. White.

ORDER NUMBER	DESCRIPTION	UNIT
1 3810	Dispenser	EA

GLOBE™ AIR-PRO METERED SPRAY REFILLS

Effective formula neutralizes strong odours. Metered valve dispenses precise spray volumes to freshen rooms up to 6,000 cubic feet. Each can contains 3,900 controlled sprays for use in closed areas. Universal tip makes this aerosol adaptable to other dispensers in the market. 180 g.

2 3800	Mango	EA
3 3801	Citrus	EA
4 3802	Linen Fresh	EA
5 3803	Green Apple	EA
6 3804	Vanilla	EA
7 3805	Ocean Breeze	EA



D FEBREZE® SMALLSPACES™ AIR FRESHENER

Gradually releases fresh-scented oils so you can forget about bad odours for 30 days. 7.5 ml.

ORDER NUMBER	DESCRIPTION	UNIT
1 37000-93336	Linen & Sky	EA
2 37000-56001	Hawaiian Aloha	EA



B MRS. MEYER'S® CLEAN DAY ROOM FRESHENERS

Give your home an instant freshening between cleaning days. Made with essential oils for a garden-inspired scent. 236 mL.

ORDER NUMBER	DESCRIPTION	UNIT
1 59200-00251	Honeysuckle Scent	EA
2 59200-00250	Basil Scent	EA
3 59200-00248	Lavender Scent	EA



C RENUZIT AIR FRESHENERS

Simple to use with no outlets or batteries needed. Adjustable fragrance levels. Lasts up to 30 days. Made with 98% biodegradable gel. 198 g.

ORDER NUMBER	DESCRIPTION	UNIT
1 2113066	Hawaiian Oasis	EA
2 2763894	Linen Escape	EA
3 2772169	Lovely Lavender	EA
4 2763142	Forever Raspberry	EA

E GLADE® AUTOMATIC SPRAY KIT

Decorative, etched design complements any room décor. Time released fragrance keeps area smelling fresh. Includes spray unit, refill and 2 "AA" batteries. Clean Linen®.



ORDER NUMBER	DESCRIPTION	UNIT
1 62300-70676	Clean Linen®	EA
GLADE® AUTOMATIC SPRAY REFILLS 175 g		
2 62300-70602	Clean Linen®	EA
3 62300-70605	Hawaiian Breeze®	EA

Check online for the most current price.

Air Care – air fresheners



A FEBREZE® AIR™ AIR FRESHENER

Spray it to knock out odors and freshen the air in any room.

ORDER NUMBER	DESCRIPTION	UNIT
1 37000-96256	Linen & Sky	EA
2 37000-96252	Gain® Original	EA
3 37000-96255	Morning & Dew	EA
4 37000-96254	Spring & Renewal	EA



B GLADE® AEROSOL

Eliminates strong persistent odors with a clean fragrance. No heavy perfume. 391g.

ORDER NUMBER	DESCRIPTION	UNIT
1 46500-77048	Clean Linen	EA
2 46500-77045	Hawaiian Breeze	EA
3 46500-77044	Super Fresh	EA
4 46500-77801	Lavender & Vanilla	EA

C GLADE® PLUGINS® SCENTED OIL STARTER KIT

Scented oil warmers provide gentle, lasting fragrance that make even larger rooms more inviting. Includes warmer and refill.



ORDER NUMBER	DESCRIPTION	UNIT
1 62300-70900	Hawaiian Breeze®	EA
GLADE® PLUGINS® SCENTED OIL REFILL		
2 62300-84101	Clean Linen®	2/PK
3 62300-80996	Hawaiian Breeze®	2/PK

D RUBBERMAID® TCELL™ ODOUR CONTROL SYSTEM

Utilizing its patented delivery system, only TCell™ consistently delivers a precise dose of high-quality fragrance blended with Microtrans®, a true odour neutralizer for 60 or 90 days without the use of batteries. White.



ORDER NUMBER	DESCRIPTION	UNIT
1 1793547	Dispenser	EA
RUBBERMAID® TCELL™ REFILLS		
2 FG402112	Blue Splash scent	EA
3 FG402470	Cucumber Melon scent	EA
4 FG402113	Citrus scent	EA



Promoting Hand Hygiene

THE FIRST LINE OF DEFENSE

Practicing good hand hygiene is one of the most effective ways to reduce the number of germs that can cause illness – and providing hand soap and sanitizer in key locations makes it easy to promote good habits.

Proven, Trusted Products

The PURELL® brand is recognized for providing world-class solutions, which lets you take credit for all the things you do to maintain a clean, high-quality facility that prioritizes guest, customer, and employee well-being. PURELL hand soaps and sanitizers provide your facility with products that are effective and that they feel great about using.

Learn more at [GOJOCanada.ca](https://www.GOJOCanada.ca)



Personal Care – hand soap



A DIAL® HYDRATING LIQUID SOAPS

Ultra fresh & fruity tropical aroma. Leaves hands feeling hydrated & smooth. 221 ml.



ORDER NUMBER	DESCRIPTION	UNIT
1 17000-08525	Spring Water	EA
2 17000-12158	Coconut Water & Mango	EA
3 17000-08524	Pomegranate & Tangerine	EA
1.53 L REFILL		
4 17000-30898	Spring Water NEW!	EA
5 17000-15083	Coconut Water & Mango	EA
6 17000-33890	Pomegranate & Tangerine	EA

C MRS. MEYER'S® CLEAN DAY FOAMING HAND SOAP

Contains aloe vera gel, olive oil, and a unique blend of essential oils that help make it naturally pure and gentle. Smells wonderful and makes hand washing a delight. 295 ml.



ORDER NUMBER	DESCRIPTION	UNIT
1 59200-00177	Apple	EA
2 59200-00178	Watermelon	EA

E SOFTSOAP® MOISTURIZING LIQUID SOAP

Moisturizing soap with aloe. Cleans gently and quickly. Pump bottle 221 ml.



ORDER NUMBER	UNIT
US04968A	EA



B DIAL® COMPLETE FOAMING HAND SOAPS

Antibacterial formula that is mild enough for daily use. 221 ml.

ORDER NUMBER	DESCRIPTION	UNIT
1 17000-09909	Power Berries	EA
2 17000-02990	Fresh Pear	EA
3 17000-09887	Spring Water	EA
946 ML REFILL		
4 17000-32075	Power Berries NEW!	EA
5 17000-32069	Fresh Pear NEW!	EA
6 17000-33896	Spring Water NEW!	EA



D MRS. MEYER'S® CLEAN DAY HAND SOAP

Contains aloe vera gel, olive oil, and a unique blend of essential oils that help make it naturally pure and gentle. Smells wonderful and makes hand washing a delight. 370 ml.

ORDER NUMBER	DESCRIPTION	UNIT
1 59200-70866	Lavender	EA
2 59200-70846	Lemon Verbena	EA
3 59200-00261	Rain Water NEW!	EA



F DIAL® CLEAN & GENTLE HYPOALLERGENIC FOAMING HAND WASH

Mild enough for daily use. pH balanced and vegan. Free from dyes, parabens, phthalates, silicones, and SLS/SLES. 221 ml.

ORDER NUMBER	DESCRIPTION	UNIT
1 17000-31356	Fragrance Free	EA
2 17000-31368	Waterlily	EA



A DIVERSY™ SOFT CARE SENSITIVE FOAM™ GENTLE FOAM HAND WASH

pH balanced and dermatologist tested luxury hand wash for frequent use. Keeps hands moisturized after repeated use. Best choice for allergy sensitive settings. Formulated with skin softening emollients. Dye-free, fragrance-free. EcoLogo, BioPreferred, NSF E-1, Kosher, Halal certified.

ORDER NUMBER	DESCRIPTION	UNIT
101106812	3.78 L	EA



B DIVERSY™ SOFT CARE® ALL PURPOSE™ HAND, HAIR & BODY WASH

Versatile solution for areas where an economic and pleasant to use all-in-one wash is desired. Skin compatibility tested, pH balanced formula leaves no sticky residue. Even application, easy rinse. Paraben and Cocamide DEA free. Lemon Tea Splash fragrance. BioPreferred, Kosher, Halal certified.

ORDER NUMBER	DESCRIPTION	UNIT
100920026	3.78 L	EA



C RMP PUMICE HAND CLEANER

Pumice scrubbing particles for extra deep cleaning. Quickly and easily removes dirt, grease, paint, ink, epoxy, tar, rust, and most industrial soils. No harsh solvents makes it acceptable for use in Canadian food processing facilities. Can be used with or without water. High quality pump included. Orange scent.

ORDER NUMBER	DESCRIPTION	UNIT
JG223	3.6 L	EA

D PURELL® ES8 TOUCH-FREE SOAP DISPENSER

Always ready, touch-free hand soap dispenser with Energy-on-the-Refill: a coin cell battery integrated into the refill. Elegant design complements any décor. LOCK OR NOT™ technology converts to a locking system. Calibrated to provide optimal dose for effective hand hygiene. Holds 1.2 L Purell ES8 Healthy Soap™ refill (not included). ADA Compliant.



ORDER NUMBER	DESCRIPTION	UNIT
1 7734-01	Graphite	EA
2 7730-01	White	EA

HEALTHY SOAP® MILD FOAM HANDWASH REFILL

Dye-free, fragrance free. 1.2 L

3 7772-02-CAN00		2/BX
-----------------	--	------

E GOJO® HEAVY DUTY SCRUBBING HAND WIPES

Formulated to lift heavy dirt and grime from skin. Contains skin conditioners to help prevent dryness. 72 sheets/tub.



ORDER NUMBER	UNIT
6396-06	EA

F OLAY® QUENCH BODY LOTION

Provides dry skin with an immediate burst of moisture that continues 24 hours.



ORDER NUMBER	DESCRIPTION	UNIT
75609-02342	350 ml	EA



G SUN ZONE® ULTRA SUNSCREEN

Provides excellent broad spectrum coverage from UVA / UVB rays. Light and non-greasy. Paraben and PABA free. Water resistant for up to 80 minutes. 177ml. Spray.



ORDER NUMBER	DESCRIPTION	UNIT
60480-25461	SPF 50	EA

H GLOBE™ HAND & NAIL BRUSH

Designed for use where personal cleanliness is of the utmost importance. Promote vital cleansing of hands for foodservice personnel. Stiffer center bristles offer a more thorough cleaning under fingernails with longer bristles on sides.



ORDER NUMBER	UNIT
4022	EA



B RUBBERMAID® AUTOFOAM SOAP / SANITIZER DISPENSER

Attractive touch-free dispenser eliminates cross-contamination to help reduce the spread of germs. Features refill level and battery life indicators. Battery life for 3 years or 120,000 hand washes. Requires 4 "C" batteries (not included). Holds 1.1 L refill (not included). ADA Compliant. Drip tray sold separately. Black and Chrome.

ORDER NUMBER	DESCRIPTION	UNIT	
1 FG750411	Dispenser	EA	\$9.99
2 1892265	Drip tray	EA	\$12.45

A RUBBERMAID® AUTOFOAM HAND SANITIZER STAND WITH DRIP TRAY

Free standing for convenient, easy access to encourage hand sanitizing. Weighted bases stabilizes the station for secure placement. Built-in drip tray to help eliminate messes. Compatible with AutoFoam dispensers (not included). 59" high. Black.

ORDER NUMBER	UNIT
FG750824	EA



NEW!

C RUBBERMAID® AUTOFOAM LUMECEL™ TOUCH-FREE DISPENSER

Touch-free delivery helps reduce cross-contamination to prevent the spread of germs. No alkaline batteries required, eliminating the task of replacing batteries. LumeCel™ technology captures energy from any indoor or natural light source to power the rechargeable energy cell. Holds 1.1 L refill (not included). ADA Compliant. 3-year warranty. Black and Chrome.

ORDER NUMBER	UNIT
1980826	EA



D RUBBERMAID® AUTOFOAM HAND SANITIZER

Enriched foam alcohol hand sanitizer kills 99% of germs on hands with active ingredient of 75% Ethyl Alcohol. Health Canada approved. Delivers up to 2,500 doses. Dye and fragrance free 1.1 L.

ORDER NUMBER	UNIT
2080802	4/CT



E RUBBERMAID® AUTOFOAM HAND SOAP WITH MOISTURIZER

Green Seal® certified hand soap dispenses a light, airy consistency that lathers quickly for an easy hand wash. Delivers up to 2,750 washes. Enriched with skin conditioners to leave hands feeling soft, even after frequent use. 1.1 L. Light Floral Scent.

ORDER NUMBER	UNIT
FG750112	4/CT



F GLOBE™ TOUCH-FREE SOAP / SANITIZER DISPENSER

Give your customers a hygienic touch-free experience. Perfect for lotion and liquid soaps and can dispense gel sanitizer with ease. Wall mounted. Output can be adjusted to 1, 2 or 3 ml depending on customer preference. Includes refillable 1 L bottle and cap.

ORDER NUMBER	DESCRIPTION	UNIT
1 4665B	Black	EA
2 4665W	White	EA

G GLOBE™ MANUAL SOAP / SANITIZER DISPENSER

Ideal for commercial and public entities, offices, restaurants, healthcare facilities, schools and hospitals. The dispenser has a 1 L (34 oz.) capacity. Wall mounted. Sight window indicates level of soap or sanitizer remaining. Includes refillable 1 L bottle.

ORDER NUMBER	DESCRIPTION	UNIT
1 4630B	Black	EA
2 4630W	White	EA





A PURELL® ES8 TOUCH-FREE HAND SANITIZER DISPENSER

Always ready, touch-free hand sanitizer dispenser with Energy-on-the Refill. LOCK OR NOT™ technology - can convert to a locking system. Calibrated to provide optimal dose for effective hand hygiene. Holds 1.2 L Purell ES8 hand sanitizer refill (not included). ADA Compliant. Refill comes with its own energy source - a coin cell battery integrated into the refill.

ORDER NUMBER	DESCRIPTION	UNIT
1 7724-01	Graphite	EA
2 7720-01	White	EA

B PURELL® ES4 HAND SANITIZER DISPENSER

Reliable, easy to maintain, push-style dispenser. AT-A-GLANCE™ refills allow you to see when they need to be changed. LOCK OR NOT™ technology - can convert to a locking system. Holds 1.2 L Purell ES4 Hand Sanitizer refills (not included). ADA Compliant.

ORDER NUMBER	DESCRIPTION	UNIT
1 5024-01	Graphite	EA
2 5020-01	White	EA



C PURELL® ADVANCED GEL HAND SANITIZER RUB REFILL

Kills 99.9% of germs on hands, including Staphylococcus aureus, Escherichia coli and Staphylococcus epidermis. Green certified, fragrance-free, dye-free gel formulation made with naturally renewable Ethanol. Clinically proven to help maintain skin health. AT-A-GLANCE™ refills to monitor product level. SANITARY SEALED™ PET refill is easily recycled. ECOLOGO® Certified. 1.2 L.

ORDER NUMBER	DESCRIPTION	UNIT
7760-02-CAN00	For ES8 Touch-free dispenser	2/BX

D PURELL® ADVANCED FOAM HAND SANITIZER RUB REFILL

Green certified, fragrance-free, dye-free foam made with naturally renewable Ethanol. Enhanced with nourishing blend of 4 different skin conditioners to help maintain skin health. AT-A-GLANCE™ refills to monitor product level. SANITARY SEALED™ PET refill is easily recycled. Chlorhexidine Gluconate (CHG) compatible formulation. Compatible with Nitrile, Vinyl, and Latex gloves. ECOLOGO® Certified.

ORDER NUMBER	DESCRIPTION	UNIT
1 5051-02-CAN00	For ES4 Push Style dispenser	2/BX
2 7751-02-CAN00	For ES8 Touch-free dispenser	2/BX



E PURELL® ADVANCED HAND RUB SINGLE USE SANITIZER

Each packet contains the right amount for one use. Easy to use, one-handed operation. Great for before & after mealtime. Single-use.

ORDER NUMBER	UNIT
9630-2M-CAN	2,000/BX

F FIRST AID CENTRAL® HAND SANITIZER GEL PACKETS

Ideal for hand sanitizing when soap and water is not available. Provides broad spectrum, fast antimicrobial effectiveness for hands and wrists. Medicinal ingredient: 2-Propanol 72% volume/volume. Health Canada approved. Single-use. 1.5 mL. 50/pkg.

ORDER NUMBER	UNIT
100290-50	PK

Personal Care – hand sanitizers



A PURELL® ADVANCED HAND SANITIZER

Kills 99.92% of the most common germs. With nourishing skin conditioners.

ORDER NUMBER	DESCRIPTION	UNIT
1 9652-12-CAN00	236 ml pump	EA
2 3770-12-CAN00	354mL pump	EA

PURELL® PAL FOR HAND SANITIZER

Capture attention & encourage frequent use with this desktop hand sanitizer holder. Holds 236 mL bottle.

3 9600-PL1-CAN	Purell®Palholder	EA
----------------	------------------	----



B ZYTEC® GERM BUSTER™ MOISTURIZING CARE HAND SANITIZER

Combines moisturizing lotion with sanitizer to keep hands soft and supple while effectively killing germs and bacteria.

ORDER NUMBER	DESCRIPTION	UNIT
60480-01232	270 mL	EA



C ZYTEC® GERM BUSTER™ HAND SANITIZER

Clear gel contains Aloe, Vitamin E and moisturizers. Safely, effectively, kills harmful germs and bacteria.

ORDER NUMBER	DESCRIPTION	UNIT
1 60480-01200	60 mL	EA
2 60480-01202	270 mL	EA
3 60480-01204	540 mL	EA
4 60480-01208	1030 mL	EA
5 60480-01219	3.78 L	EA



D ZYTEC® GERM BUSTER™ EXTRA STRENGTH HAND SANITIZER SPRAY

Extra strength formula with 80% alcohol kills harmful bacteria and germs on contact.

ORDER NUMBER	DESCRIPTION	UNIT
1 60480-01345	250 mL	EA
2 60480-01346	500 mL	EA



E ZYTEC® GERM BUSTER™ EXTRA STRENGTH HAND SANITIZER WIPES

Convenient, premium quality wipes with extra strength 80% Alcohol formula kills harmful germs and bacteria, sanitizing on contact. Use directly on your hands to kill illness-causing germs. Resealable container for long-term use. Each wipe is 17cm×20 cm.

ORDER NUMBER	UNIT
1 60480-01355	100/EA
2 60480-01356	800/EA



F ZYTEC® GERM BUSTER™ FRAGRANCE-FREE, DYE-FREE HAND SANITIZER

Enriched with aloe, vitamin E and additional moisturizers, the clear gel leaves your hands smooth and soft. Contains 70% Alcohol and approved by Health Canada. 1L pump.

ORDER NUMBER	UNIT
60480-01217	EA

CLEANING, BREAKROOM AND FACILITIES

G PURELL® HAND SANITIZING WIPES

Sanitizing wipes kill 99.99% of the most common germs. Removes light soils and dirt. Fragrance free, dye free.

ORDER NUMBER	DESCRIPTION	UNIT
1 9030-12-CAN00	Alcohol	80/EA
2 9113-06-CAN00	Non-alcohol	270/EA



H ZYTEC® GERM BUSTER™ FOAMING HAND SANITIZER

No mess formula keeps your hands clean. 550 mL.

ORDER NUMBER	DESCRIPTION	UNIT
1 60480-01504	Alcohol free	EA
2 60480-01404	Alcohol 70%	EA



A ST. JOHN AMBULANCE GENERAL OFFICE FIRST AID KIT

Meets occupational health and safety regulations. 150 pieces/kit.



ORDER NUMBER	UNIT
69070	EA



C PARAMEDIC FIRST AID KIT

Portable first aid kit is ideal for all types of activities. Soft case. Nylon. Red. 150 pieces/kit.

ORDER NUMBER	UNIT
999-1000	EA



E PARAMEDIC FIRST AID SAFETY KIT

Ideal for businesses. Wall mountable. Hard plastic case. White. 124 pieces/kit.

ORDER NUMBER	UNIT
999-2500	EA

F FIRST AID CENTRAL® BASIC BURN KIT

Be prepared for burn emergencies with essential supplies to treat injuries. Plastic case with wall mounts and carrying handle. Includes: two 2"×6" and one 4"×4" burn dressings; three burn gel packs; one 4"×15' stretch bandage; one pair examination gloves; one roll adhesive tape; and one pair scissors.



ORDER NUMBER	UNIT
FACBK01	EA

First aid



B NEXCARE™ ACTIVE™ FIRST AID KITS

Broad range of bandages, swabs and dressings for most small office/home needs.

ORDER NUMBER	DESCRIPTION	UNIT
1 7721P	64 pieces/kit	EA
2 7730	174 pieces/kit	EA



D PARAMEDIC FIRST AID CSA SAFETY KITS

Ideal first aid kit for businesses. White.

ORDER NUMBER	DESCRIPTION	UNIT
--------------	-------------	------

LOW TO MODERATE RISKS

1 999-2008	Small, 1-25 Employees	EA
2 999-1987	Medium, 26-50 Employees	EA
3 999-2007	Large, 50+ Employees	EA

HIGH RISKS

4 999-1990	Small, 1-25 Employees	EA
5 999-1991	Medium, 26-50 Employees	EA
6 999-1992	Large, 50+ Employees	EA

G FIRST AID CENTRAL® ALL WEATHER ROAD SAFETY KIT

Be prepared for automotive emergencies. Packed in a high quality nylon bag with individual compartments. Includes: booster cables (8G/8'), reflective safety vest, multi-function screwdriver, mylar rescue blanket, flasher w/clip, flashlight, S.O.S Flag, quick fix tire sealant, tire pressure gauge and one pair nitrile dipped work gloves. Also includes first aid kit with: five plastic adhesive bandages ¾"×3", five junior bandages, fingertip bandage, knuckle bandage, fabric patch bandage 2"×4", gauze pad 2"×2", two BZK antiseptic wipes, two alcohol antiseptic wipes, two hand cleansing towelettes, first aid instruction card.



ORDER NUMBER	UNIT
FAC-085	EA

CLEANING, BREAKROOM AND FACILITIES

First aid



A FIRST AID CENTRAL® 5 DAY PANDEMIC PROTECTION KIT

Everything you need to protect yourself against a pandemic. Comes in a re-sealable bag. Includes: five 3-ply face masks, five pairs of vinyl exam gloves, ten disinfectant alcohol wipes, instant hand sanitizer (2oz), and a disposable thermometer.

ORDER NUMBER	UNIT
PAN08	EA



D NEXCARE™ WATERPROOF CLEAR BANDAGES

Unique bandage shape provides superior waterproof protection against water, dirt and germs. ultra-thin, clear breathable material.

ORDER NUMBER	UNIT
588-30-CA	30/BX



G FIRST AID CENTRAL® PLASTIC BANDAGES

Protects minor wounds, scrapes and cuts from infection. Breathable and sterile. Latex-free.

ORDER NUMBER	DESCRIPTION	UNIT
500004	¾"×3"	25/BX



B NEXCARE™ COMFORT STRIPS BANDAGES

Material breathes to help skin stay dry and cool. Latex-free. Stretches and conforms.

ORDER NUMBER	DESCRIPTION	UNIT
1 CS102-CA	¾"×3"	80/BX
2 CS203-CA	Assorted	80/BX



E PARAMEDIC FABRIC BANDAGES

Sterile and hypoallergenic with a long lasting strong adhesive. Latex-free. Conforms to joint and hard-to-bandage areas.

ORDER NUMBER	DESCRIPTION	UNIT
FINGERTIP		
1 999-0324-50	1¾"×3"	50/BX
KNUCKLE		
2 999-0323-50	1½"×3"	50/BX
REGULAR		
3 999-0322	¾"×3"	100/BX



H PARAMEDIC SKIN CLOSURES

Ideal to close the two edges of a minor wound. Can be cut off at desired length. ¼"W×3"L.

ORDER NUMBER	UNIT
999-1157	6/BX



C NEXCARE™ HEAVY DUTY FABRIC BANDAGES

Woven fabric material moves with you. 360-degree seal keeps out dirt and germs. Assorted sizes.

ORDER NUMBER	UNIT
HD202-CA	40/BX



F FIRST AID CENTRAL® FABRIC BANDAGES

Flexible, lightweight adhesive fabric. Sterile. Latex-free. 50/box.

ORDER NUMBER	DESCRIPTION	UNIT
1 500118	1"×3", Regular	50/BX
2 500126	1¾"×3", Fingertip	50/BX
3 500141	3"×1½", Knuckle	50/BX



I FIRST AID CENTRAL® CHILDREN'S ADHESIVE BANDAGES

Cartoon style bandages to appeal to small children. Protects minor wounds, scrapes and cuts from infection. Breathable and sterile. Plastic. Latex-free. ¾"×2⅞". 30/box.

ORDER NUMBER	UNIT
500220	30/BX



A PARAMEDIC MEDICAL TAPE

Helps keep bandages and splints in place. Hypoallergenic and latex free. 1"Wx30"L.

ORDER NUMBER	DESCRIPTION	UNIT
MICROPOROUS - PAPER		
1 999-0504	Tape	EA
TRANSPOROUS - PLASTIC		
2 999-0361	Tape	EA



B FIRST AID CENTRAL® WATERPROOF ADHESIVE TAPE

Strong adhesives hold dressings in place even when wet. Easy to tear. 1"Wx15"L.

ORDER NUMBER	UNIT
500054	EA



C FIRST AID CENTRAL® FIRST AID CLOTH TAPE

Strong and economical cloth tape ideal for any first aid kit. Latex free. 1"x15"(5yrd).

ORDER NUMBER	UNIT
500068	EA



D FIRST AID CENTRAL® GAUZE PADS

High quality, sterile 12-ply gauze dressing pads. Individually wrapped.

ORDER NUMBER	DESCRIPTION	UNIT
1 150325	3"x3"	25/PK
2 150425	4"x4"	25/PK



E PARAMEDIC NON STERILE SPONGES

4-ply gauze to clean closed wounds or reinforce dressings. Used where there are no open wounds. 2"x2".

ORDER NUMBER	UNIT
1 999-1125	200/BX
PARAMEDIC STERILE SPONGES	
Use to disinfect or cover wounds. Can apply on top of cream or directly on the wound to absorb discharge and protect from contamination. 2"x2".	
2 999-1015	10/BX



F FIRST AID CENTRAL® PRESSURE BANDAGE

Used to control and stop bleeding by applying pressure. Non-adherent surface will not stick to the wound. Sterile and highly absorbent.

ORDER NUMBER	DESCRIPTION	UNIT
1 150007	4"x4"	EA
2 150009	6"x6"	EA



G PARAMEDIC EYE PADS

Cover the eye in case of laceration, burns or other injuries. 2½"x1¾".

ORDER NUMBER	UNIT
999-1155	5/BX



H FIRST AID CENTRAL® OVAL EYE PATCH

Sterile oval eye patch pad to be used for eye injury care and medication application. Breathable backing. Absorbent non-stick pad. Individually wrapped.

ORDER NUMBER	UNIT
150132	10/PK



I FIRST AID CENTRAL® ABDOMINAL PAD

Sterile abdominal/combine pads for use where high absorbency is needed for heavy draining wounds. Can also be used as added comfort with splints. 5"x9".

ORDER NUMBER	UNIT
150026	EA

First aid



A FIRST AID CENTRAL® CONFORMING GAUZE BANDAGE

Conforms to the contour of the body. Helps keep dressings in place. Sterile. Individually wrapped.

ORDER NUMBER	DESCRIPTION	UNIT
1 200002	2"×15'	EA
2 200003	3"×15' stretched	EA



B PARAMEDIC ADHESIVE DRESSING COVER

Used to maintain a compress in place. Latex free. 4" W×39" L.

ORDER NUMBER	UNIT
999-1151	EA



C FIRST AID CENTRAL® TRIANGULAR BANDAGE

Great to use as a sling to support arms and shoulders, apply as a pressure dressing, immobilize hands and feet and as a tourniquet to control bleeding. 100% cotton, individually wrapped, complete with two safety pins. 40"×40"×56".

ORDER NUMBER	UNIT
150030	EA



D PARAMEDIC TRIANGULAR BANDAGE

Use as scarf to keep injured limbs to the chest or use to make a temporary splint.

ORDER NUMBER	DESCRIPTION	UNIT
999-0598	40"×40"	EA



E PARAMEDIC ELASTIC BANDAGE

Immobilize joints having suffered a minor injury. Provide articulation the necessary support for recovery. Washable fabric.

ORDER NUMBER	DESCRIPTION	UNIT
1 999-1003	2" W×15' L	EA
2 999-1005	4" W×15' L	EA



F FIRST AID CENTRAL® ELASTIC WRAP BANDAGE

Lightweight, non-fraying bandage provides tension, firm support and compression. Individually wrapped, reusable. Includes metal fastening clips. 3"×15'.

ORDER NUMBER	UNIT
200006	EA



G PARAMEDIC SELF-ADHESIVE WRAP

Provides compression where needed. No clip or pins required – it sticks to itself. Used to immobilize joints having suffered injury. Made of elastic tissues containing latex. 15' L.

ORDER NUMBER	DESCRIPTION	UNIT
1 999-1022	2" W	EA
2 999-1023	3" W	EA



H PARAMEDIC TWEEZERS

Used to extract objects too small to be easily handled by hand.

ORDER NUMBER	DESCRIPTION	UNIT
1 999-5011	3½"	EA
PARAMEDIC BANDAGE SCISSORS		
Ideal for safety kits. Curved blades to facilitate cutting dressings close to the skin.		
2 999-5018	4½"	EA



I PARAMEDIC BIOWASTE CONTAINER

Dispose of biowaste products such as syringes, needles, blood vials and lancets. 5.1 L.

ORDER NUMBER	UNIT
077-0974	EA



A PARAMEDIC HYDROGEN PEROXIDE

A topical antiseptic. Use to sterilize medical instruments and other surfaces. 250 ml.

ORDER NUMBER	UNIT
999-0465	EA



B PARAMEDIC RUBBING ALCOHOL

Made of 70% isopropyl alcohol. Used primarily as a topical antiseptic. 500 ml.

ORDER NUMBER	UNIT
999-0464	EA



C PARAMEDIC ALCOHOL SWABS

Use to disinfect wounds before applying a bandage. For external use only. Can be included as a refill for safety kits.

ORDER NUMBER	UNIT
999-0462	200/PK



D FIRST AID CENTRAL® ANTISEPTIC/ CLEANING WIPES

For effective cleansing of wounds and skin. Saturated with 0.13% Benzalkonium chloride liquid solution. Alcohol Free. Does not sting. Individually Wrapped.

ORDER NUMBER	UNIT
100001U12	12/PK



E FIRST AID CENTRAL® ANTIBIOTIC OINTMENT-BACITRACIN ZINC POUCHES

Helps prevent/reduce infection and aids in the healing of minor cuts, scrapes and burns. Each pouch contains 0.9g of ointment. Individual, single use pouches.

ORDER NUMBER	UNIT
100002U12	12/PK



F PARAMEDIC EMERGENCY BURN GEL PACKS

Hydrates, chills and helps to prevent infection. Ideal for light to moderate burns. Hydrogel is made from Tea Tree oil. 3.5 ml.

ORDER NUMBER	UNIT
999-55004	2/PK



G PARAMEDIC COTTON BALLS

Used to stop or prevent bleeding from minor punctures or in the application and removal of makeup.

ORDER NUMBER	UNIT
999-1190	500/PK



H PARAMEDIC TONGUE DEPRESSORS

For examining the mouth and throat. Made of wood.

ORDER NUMBER	UNIT
008-0150	100/BX

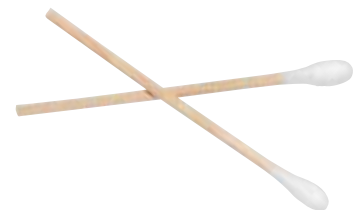

I DYNAMIC COTTON-TIPPED APPLICATORS

Single-end cotton tip over hardwood applicator. Ideal for wound cleansing and material application. 3".

ORDER NUMBER	UNIT
FACA003	100/PK

First aid



A PARAMEDIC INSTANT COLD PACKS

Twist for instant cold. Use to reduce pain, muscle spasms and calm inflammation. External use only.

ORDER NUMBER	DESCRIPTION	UNIT
1 999-0908	4"×6"	EA
2 999-0909	6"×10"	EA



B FIRST AID CENTRAL® INSTANT COLD PACK

For instant cold therapy in emergency situations. Use to active, single use.

ORDER NUMBER	DESCRIPTION	UNIT
1 700000	4"×5"	EA
2 700006	6"×19"	EA



C RAPID-RELIEF® REUSABLE COLD/HOT GEL COMPRESS

Used for ongoing, repeated-use hot and cold therapy treatments. Microwaveable. Non-toxic and latex-free. 9"×11".

ORDER NUMBER	UNIT
700008	EA



D POLYSPORIN® TOPICAL TREATMENT

Prevents infection and assists in the healing of minor cuts, nicks, scratches, scrapes and abrasions. Soothing ointment forms a protective coating. Non-stinging and odourless. 15 g.

ORDER NUMBER	DESCRIPTION	UNIT
1 SAY444	Heal-Fast® Ointment	EA
2 SAY443	Cream	EA



E TYLENOL®

Tough on pain, but gentle on your stomach, providing fast, effective relief of headaches, aches, pain and fever.

ORDER NUMBER	DESCRIPTION	UNIT
25MI148	500 mg Caplets	10/PK



F PERSONNELLE ACETAMINOPHEN CAPLETS

Use to relieve minor pain associated with headaches, fever and muscle aches. Easy to swallow caplets. Regular Strength. 325 mg.

ORDER NUMBER	UNIT
250002	100/PK

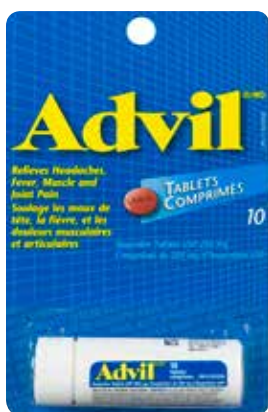

G ADVIL® TABLETS

Its coating makes it easy to swallow. For fast and effective relief of headache, muscle & joint pain, pain from inflammation associated with arthritis or physical overexertion, backache, menstrual pain, toothache pain, and for reduction of fever.

ORDER NUMBER	DESCRIPTION	UNIT
25MI536	200 mg	10/PK



H PHYSICIANS CARE® EMERGENCY EYE & FACE WASH STATION

Eye flushing solution helps irrigate eyes to relieve irritation or burning. Easy flow nozzle helps fluid flush affected area. Health Canada approved. Tamper evident bottle to ensure sterility. 98.3% purified water.

ORDER NUMBER	DESCRIPTION	UNIT
1 100485	500ml Solution	EA
SINGLE EYEWASH STATION		
Health Canada approved, single bottle station. Wall mountable. Includes eye wash solution.		
2 560003	Station + 500ml Eye Wash Solution	EA



I ROLAIDS® EXTRA STRENGTH ANTACID CHEWABLE TABLETS

There's never a good time to have heartburn. Rolaids® Extra Strength tablets for fast, powerful relief from heartburn symptoms. Relieves: heartburn, sour stomach, acid indigestion. Assorted Fruit.

ORDER NUMBER	UNIT
25MI358	12/PK



A FIRST AID CENTRAL® HAND SANITIZER GEL PACKETS

Ideal for hand sanitizing when soap and water is not available. Provides broad spectrum, fast antimicrobial effectiveness for hands and wrists. Medicinal ingredient: 2-Propanol 72% volume/volume. Health Canada approved. Single-use. 1.5 mL.

ORDER NUMBER	UNIT
100290-50	50/PK

B FIRST AID CENTRAL® HAND CLEANING TOWELETTES

Scented moist towelettes used to freshen up and cleanse as needed. Individually wrapped.



ORDER NUMBER	UNIT
100170	100/PK

C FIRST AID CENTRAL® CPR FACE SHIELD WITH FILTER

Physical protection barrier for safe mouth to mouth resuscitation. Great addition to your first aid kit. Disposable. Individually packed and sealed in a poly-bag. One way valve filter eliminates blow back of bodily fluids to rescuer.



ORDER NUMBER	UNIT
350002	EA

D FIRST AID CENTRAL® CPR POCKET MASK

One way valve with filter provides both the victim and rescuer with a safe and effective means to perform CPR. Health Canada approved. Includes head strap, carrying case and a pair of vinyl examinations gloves and instructions.



ORDER NUMBER	UNIT
370001G	EA

E PARAMEDIC DOUBLE FOLD POLE STRETCHER

Stretcher with tubular aluminum poles with two cross spreader bars.

ORDER NUMBER	UNIT
999-5701	EA



F FIRST AID CENTRAL® DOUBLE-FOLD STRETCHER

Lightweight aluminum pole stretcher. Heavy-duty rigid tubular poles and cross spreaders. Rubber hand grips for secure and comfortable carrying. Fabric is easy to clean, antibacterial, fireproof, waterproof and resists cracking. Folds length and widthwise for easy storage. Durable 18 oz vinyl-coated nylon. Includes convenient carry bag with shoulder strap.

ORDER NUMBER	DESCRIPTION	UNIT
310007	56"×80"	EA

G PARAMEDIC ALUMINUM BLANKET

Used to keep in the heat of an injured person to prevent shock. Grey.

ORDER NUMBER	UNIT
999-0707	EA



H PARAMEDIC POLYESTER BLANKET

Provides protection in an emergency. Grey.

ORDER NUMBER	DESCRIPTION	UNIT
999-4172	41"×72"	EA





A BIOS DIAGNOSTICS COMPACT BLOOD PRESSURE MONITOR

Delivers the accuracy and precision you expect in half the size. Memory - 1 user, 99 blood pressure readings. Averages all stored readings. Cuff ranges from 8.7" - 16.5" (22 - 42 cm). Includes storage bag and log book. Runs on 4 x AA batteries (included).

ORDER NUMBER	UNIT
BD216	EA



B BIOS LIVING OVER BED TABLE

Height adjustable table for either conventional or hospital beds. Adjustable height from 30" - 47". Supports up to 10 lbs.

ORDER NUMBER	UNIT
LF844	EA



C BIOS LIVING FOOTREST

Eliminate leg and back pain while improving posture during long work days. Durable metal tub frame features rubber ends to prevent slips and scratches.

ORDER NUMBER	UNIT
LF209	EA



D BIOS NON-CONTACT FOREHEAD THERMOMETER

Delivers the accuracy and precision you expect in half the size. Memory - 1 user, 99 blood pressure readings. Averages all stored readings. Cuff ranges from 8.7" - 16.5" (22 - 42 cm). Includes storage bag and log book. Runs on 4 x AA batteries (included).

ORDER NUMBER	UNIT
7741	EA



E FIRST AID CENTRAL® PRO DIGITAL THERMOMETER

Digital thermometer with a flexible tip. Fast response. Stores last temperature, large LCD, automatic shut off, sound signal when temperature is reached and dual °F or °C reading. Requires 1 "1.5" volt battery (included).

ORDER NUMBER	UNIT
550107	EA



F CLOROX HEALTHCARE™ PROFESSIONAL DISINFECTING BLEACH WIPES

One-step cleaner and disinfectant. Pre-moistened, strong, durable, cloth-like wipe. Health Canada-registered to kill C. difficile spores in 3 minutes, and 46 pathogens in 1 minute. 70 sheets/tub.

ORDER NUMBER	UNIT
55500-01308	EA

CLEANING, BREAKROOM AND FACILITIES



G CLOROX HEALTHCARE™ HYDROGEN PEROXIDE CLEANER DISINFECTANT WIPES

Pre-moistened, durable cloth-like wipes. Recommended for everyday cleaning and high-touch surfaces. Health Canada registered disinfectant. Kills 38 pathogens in 1 minute or less. 6 3/4x9". 95 sheets/tub.

ORDER NUMBER	UNIT
55500-01456	EA

H CLOROX HEALTHCARE™ BLEACH GERMICIDAL CLEANER

Health Canada registered, one step, ready-to-use hospital-grade disinfectant. Perfect for toilet bowls and sinks. Effective against C. difficile spores in 3 minutes and 36 pathogens in 1 minute. 946 mL.

ORDER NUMBER	UNIT
55500-01416	EA



I OXIVIR® TB WIPES

Hospital grade disinfectant. AHP technology. Kills TB, Norovirus, HIV, etc. in 1 minute. Non-irritating. No VOC's. Three year shelf life. 160 sheets/tub.

ORDER NUMBER	UNIT
5144708	EA

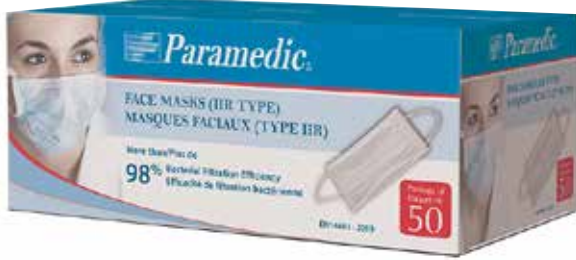

A PARAMEDIC SURGICAL MASK

More than 98% bacterial filtration efficiency. Latex-free. IIR Type. Disposable.

ORDER NUMBER	UNIT
999-1020	50/BX



B COMFORT TIME DISPOSABLE MASKS

Nose clip. Three layers: hydrophobic non woven 25.2g; melt blown non woven 25g; hydrophobic non woven 25g. FDA/CE/Iso9001/Iso14001 Certificates. Bacterial Filtration Efficiency of 95%.

ORDER NUMBER	UNIT
808887-492938	50/BX



NEW!



C RONCO PRO-TEC® MEDICAL MASKS

Three ply disposable. Pleated. Level 3 certified. Blue.

ORDER NUMBER	UNIT
5633	50/BX



D RONCO N95 MASKS

Individual automated packaging helps protect the respirator from contamination before use. Conforms to eye and nose contours of the face insuring more room for eyewear. Adjustable nose clip with soft and comfortable fog-reducing foam. Head straps are internally welded and are 100% latex-free. Excellent resistance against bodily fluids and blood.



ORDER NUMBER	UNIT
6335	30/BX



E WINNABLE KIDS DISPOSABLE MASKS

These three layer disposable masks provide protection against dust and stop droplets from spreading. Level 2 certified. Blue.

ORDER NUMBER	UNIT
MA-01K-2	10/PK

NEW!

F GLOBE™ KN95 MASKS

Tested with 98% filtration with a tight fitting design. Flexible design and rounded shape provides optimal comfort and substantial breathing area. CDC and Health Canada approved. Individually packed for better hygiene. Features 4 layers of protection. Ear loops. Level 3.

ORDER NUMBER	DESCRIPTION	UNIT
1 7765	Adults	20/BX
2 7777	Kids	20/BX



G 3M™ SANDING & FIBREGLASS N95 RESPIRATORS

Lightweight design with soft interior foam that rests on the bridge of nose for comfort. Disposable. NIOSH-approved. Advanced Electrostatic Media that enhances the capture of airborne particles. Welded stretchable headband and adjustable nose clip.



ORDER NUMBER	DESCRIPTION	UNIT
1 8511HA1-C-PS	With Cool Flow™ valve	EA
2 8210H2-DC	No valve	2/PK

H FILEMODE MEDICAL MASK CADDY AND ORGANIZER

Three compartment design with two top organizer compartments. Easy to sterilize and clean with common cleaning solvents. Great for in the car, at the office or school. Holds up to 40 masks. Polypropylene. 8½"W×5"D×2½"H. Clear.



ORDER NUMBER	UNIT
92963	EA



A WINNABLE MEDICAL FACE SHIELD

Protective isolation mask and elastic band. Double sided anti-fog. 13"×8". Clear.

ORDER NUMBER	UNIT
MS-01	EA

B RONCO CARE® PLEATED BOUFFANT CAP

Unique accordion pleated style to refold with a snap of the wrist at shift changes. Barrier against fine dust and dry particles. Nonwoven Polypropylene. Latex-free. 21" diameter. White.



ORDER NUMBER	UNIT
7021W	100/PK

C RONCO EASY BREEZY™ HONEYCOMB MESH BEARD COVER

Ideal in clean or HACCP compliant work environments to prevent facial hair from contaminating food. Features a non-binding latex-free elastic tieback. 16 gsm Polyester mesh. 21"×9". Brown.



ORDER NUMBER	UNIT
1794	100/PK

D RONCO EASY BREEZY™ INVISIBLE MESH HAIRNETS

Mesh hairnets are ideal for food prep, healthcare, or other industrial applications. A non-latex elastic band, comfortable for all day wear. Nylon. Latex-free. 21" diameter. Brown.

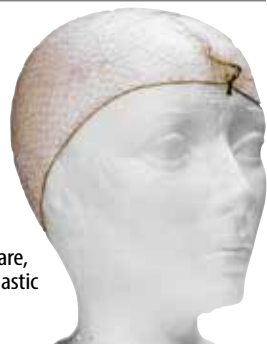

ORDER NUMBER	UNIT
1848BR	100/BX



E GLOBE™ DISPOSABLE COVERALLS

Non-woven fabric provides a good basic layer of protection. Features a zipper closure and elastic wrists and ankles. Polypropylene. White.

ORDER NUMBER	DESCRIPTION	UNIT
1 7720H	Medium	25/BX
2 7721H	Large	25/BX
3 7722H	X-Large	25/BX

NEW!



F ZENITH® POLYETHYLENE APRON

Bib-style apron with waist ties. Disposable. Polyethylene. 35"×46". White.

ORDER NUMBER	UNIT
SEK351	100/PK



G RONCO CARE™ DISPOSABLE SHOE COVERS

Fits most shoe sizes. Anti-slip for fall protection. Non-woven polypropylene covers with stretch opening. Blue.

ORDER NUMBER	DESCRIPTION	UNIT
1 1943B	Regular	100/PK
2 1946B	Extra Large	100/PK



H RONCO COVERME™ CPE DISPOSABLE SHOE COVERS

Shoe covers help protect carpet, tile or wood floors from dirt, mud, scuff marks or other contaminants. Strong, Latex-free elastic. Regular. Blue.

ORDER NUMBER	UNIT
1995	100/PK



A ZENITH® Z500 SERIES SAFETY GLASSES

Frameless design with extended wraparound coverage. Scratch-resistant polycarbonate lens with UV protection. Non-slip rubber head grips, distortion-free. Compliant with CSA standard Z94.3 and ANSI Z87+. Clear frame with Clear lens.

ORDER NUMBER	DESCRIPTION	UNIT
SAP877	Clear	EA



B NOVA™ NON-SLIP SAFETY GLASSES

Great for industrial, healthcare, or food processing environments. Features non-slip temples, a soft nose bridge for comfort, and offers great coverage. Polycarbonate frame with coated clear lens. Black frame.

ORDER NUMBER	DESCRIPTION	UNIT
82-450	Non-slip	EA



C NOVA™ ADJUSTABLE SAFETY GLASSES

Ideal for general industrial or healthcare applications or can be used in food processing environments. Features an adjustable telescoping temple and molded nose bridge. Scratch resistant, durable, and lightweight. Polycarbonate frame with coated clear lens and side shields. Black frame.

ORDER NUMBER	DESCRIPTION	UNIT
82-150	One size	EA



D 3M™ OVER-THE-GLASS SAFETY EYEWARE

Made to be worn over most prescription eyewear. Designed with polycarbonate lenses - the strongest, most impact-resistant eyewear lens material available. A great choice in eye protection for both the professional and the DIYer who wear prescription eyewear.

ORDER NUMBER	DESCRIPTION	UNIT
47110H1-DC	Clear	EA



E NOVA™ VISITOR SAFETY GLASSES

Ideal for use in general industrial or manufacturing environments where dust or other particulates might be present. Scratch resistant, durable and lightweight. Polycarbonate frame with coated clear lens and side shields. Clear frame.

ORDER NUMBER	DESCRIPTION	UNIT
82-250	Visitor	EA



F NOVA™ E SERIES ONE-PIECE LENS SAFETY GLASSES

Single piece lens fits most faces. Molded in nose bridge provides uncompromised comfort and fit. Built in side impact protection. Lightweight and modern. Outstanding field of vision. Meets or exceeds CAN/CSA Z94.3-07

ORDER NUMBER	DESCRIPTION	UNIT
82-050	One-piece lens	EA



G CLEAR® LENS CLEANING SOLUTION REFILL

16oz spray bottle of solution formulated for anti-fog and scratch-resistant hardcoats. Alcohol and silicone free.

ORDER NUMBER	UNIT
SP-S471	EA



H PHYSICIANS CARE EYE WASH

Use to flush or irrigate the eye to remove loose foreign material or air pollutants. 125 mL.

ORDER NUMBER	UNIT
38743-00092	EA



I WINNABLE SAFETY GOGGLES

Adjustable elastic head strap, crystal clear anti-fog lens and four unique ventings. Impact and scratch resistant.

ORDER NUMBER	UNIT
MGOG-01	12/BX

Safety – ear protection

A 3M™ TEKK PROTECTION™ DISPOSABLE EARPLUGS

Reduces noise levels to 32 dB. 4 pairs/pk.

ORDER NUMBER	UNIT
92050H4-DC	PK



C 3M™ TEKK PROTECTION™ REUSABLE EARPLUGS

Triple flange design for a comfortable snug fit. Cord reduces the chance of losing the earplugs. Provides easy in/out application. Includes handy storage container. 1 pair/pk.

ORDER NUMBER	UNIT
90586H1-DC	PK



E 3M™ PELTOR™ OPTIME™ 98 SERIES EARMUFFS

Slim tapered upper dome, excellent for use with hard hat and face protection equipment. Suitable for factories, sheet metal works, schools, printing offices, textile industries and power equipment. CSA Class A. Headband. Pressure equalization air openings, quickly ensure the correct pressure to the eardrum. Rated NRR 25 dB. Yellow.

ORDER NUMBER	UNIT
H9A	EA



B RONCO HUSH™ SINGLE USE EARPLUGS

Single use 32NRR earplugs. Soft, low pressure foam for comfort and fit. Tapered shape adjusts to most ear canals. ANSI S3.19-1974 certified. Citron.

ORDER NUMBER	DESCRIPTION	UNIT
50-13	Uncorded	200/BX



D 3M™ TEKK DISPOSABLE FOAM EARPLUGS

Ultra soft, low pressure foam for all day comfort. Resists sweat and humidity absorption. Reduces noise levels to 32 dB. 80 pairs/box.

ORDER NUMBER	UNIT
92059H80-DC	BX



F 3M™ TEKK PROTECTION™ FOLDING EARMUFFS

Folds away for easy storage. Liquid foam ear cushions. NRR 23dB.

ORDER NUMBER	UNIT
90563H1-DC	EA



H HONEYWELL HOWARD LEIGHT™ VERISHIELD™ DIELECTRIC PASSIVE EARMUFFS

Comfortably fits a wide range of head sizes. Wide cup opening is ideal for workers with large ears, or who wear hearing aids. Lightweight cushioned headband. Memory foam ear cushions. Oil-resistant cup surface withstands oily, heavy-work environments and frequent cleaning. Features Sound Management Technology (SMT) which improves employee safety by blocking harmful noise while allowing voices and signals to be heard more naturally. Designed for use with other PPE. NRR 23 dB. CSA Class A certified. Black.

ORDER NUMBER	DESCRIPTION	UNIT
1035190-VS	NRR 21 dB	EA



G 3M™ KIDS HEARING PROTECTION

Helps protect little ears from big sounds. Features steel-reinforced headband, foldable design, padded ear cups, and adjustable sliders to accommodate head size.

ORDER NUMBER	DESCRIPTION	UNIT
1 PKIDSP-TEAL-CA	Cushioned headband, Teal	EA
2 PKIDSB-BLU-CA	Flexible headband, Blue	EA



✓ Uses:
Medical
Food Prep
Frequent Changes



A RONCO VE1 EXAMINATION VINYL GLOVES

Ambidextrous for easy donning. Latex free. Powder free. 3 mil. Clear.

ORDER NUMBER	DESCRIPTION	UNIT
1 231S	Small	100/BX
2 231M	Medium	100/BX
3 231L	Large	100/BX
4 231XL	X-Large	100/BX

✓ Uses:
Food Prep
Frequent Changes



B RONCO VE2 EXAMINATION VINYL GLOVES

Ambidextrous for easy donning. Beaded cuffs prevent liquid roll down. Latex free. Powder free. 4 mil. Clear.

ORDER NUMBER	DESCRIPTION	UNIT
1 1223PF	Small	100/BX
2 1233PF	Medium	100/BX
3 1243PF	Large	100/BX
4 1253PF	X-Large	100/BX

✓ Uses:
Dental
Laboratory
Pharmaceutical



C RONCO NITECH® EDT EXAMINATION GLOVES

Ambidextrous for easy donning. Latex free and disposable. Powder free. 5 mil. Blue.

ORDER NUMBER	DESCRIPTION	UNIT
1 365	Small	100/BX
2 375	Medium	100/BX
3 385	Large	100/BX
4 395	X-Large	100/BX

✓ Uses:
Dental
Pharmaceutical
Food Prep

NEW!



D RONCO EARTH BIODEGRADABLE NITRILE EXAMINATION GLOVES

Premium biodegradable gloves use advanced patented technology to accelerate the degradation process in biologically active landfills. These gloves break down in 1 to 5 years compared to the standard 100 plus years for regular nitrile. Powder-free. Latex. 3 mil. Violet.

ORDER NUMBER	DESCRIPTION	UNIT
1 936S	Small	100/BX
2 936M	Medium	100/BX
3 936L	Large	100/BX
4 936XL	X-Large	100/BX

✓ Uses:
Medical
Chemotherapy
Drug Handling



E RONCO BLURITE™ PLUS EXAMINATION GLOVES

Accelerator free to reduce risks of Type IV allergic reactions. Tested for use with chemotherapy drugs. Compliant for contact with food. Disposable. Powder free. Nitrile. 4 mil. Violet.

ORDER NUMBER	DESCRIPTION	UNIT
1 976	Medium	100/BX
2 986	Large	100/BX

NEW!



F FIRST AID CENTRAL® SYNTHETIC EXAMINATION GLOVES

Soft and flexible for comfortable wear. Great wet and dry grip. Non-sterile. Latex-free. Powder-free. Large.

ORDER NUMBER	UNIT
C0177-SPE-50L	100/BX

✓ Uses:
Medical
Food Prep
Industrial



G RONCO LE2 LATEX EXAMINATION GLOVES

Ambidextrous for easy donning. Beaded cuffs. Chlorinated on inner surface, Polymer coated on outer surface. Non-Sterile. Made from premium natural rubber latex. Powder free. 4 mil. Tan.

ORDER NUMBER	DESCRIPTION	UNIT
1 1823	Small	100/BX
2 1833	Medium	100/BX
3 1843	Large	100/BX
4 1853	X-Large	100/BX

✓ Uses:
Medical
Food Production
Food Service

H RONCO NE2 EXAMINATION GLOVES

Ambidextrous for easy donning. Chemical and solvent resistant. Latex free and disposable. Powder free. Nitrile. 4 mil. Blue.

ORDER NUMBER	DESCRIPTION	UNIT
1 945S	Small	100/BX
2 945M	Medium	100/BX
3 945L	Large	100/BX
4 945XL	X-Large	100/BX



Safety – gloves

✓ **Uses:**
Anywhere the same gloves will be worn for a prolonged period of time



A RONCO ALOE SYNTHETIC GLOVES

Ambidextrous for easy donning. Beaded cuffs prevent liquid roll down. Aloe infused, keeps hands from drying out. Powder free. 5 mil. Green.

ORDER NUMBER	DESCRIPTION	UNIT
1 637M	Medium	100/BX
2 647L	Large	100/BX

✓ **Uses:**
Agriculture
Food Handling
Janitorial
Fishery
Pharmaceutical



B RONCO LIGHT-FIT™ GLOVES

Compliant for contact with food. Chemical and solvent resistant. Flocklined. Latex. Textured grip. Yellow.

ORDER NUMBER	DESCRIPTION	UNIT
1 15-332-08	Medium	12/PK
2 15-332-09	Large	12/PK

✓ **Uses:**
Automotive
Police Services
Security



C RONCO SENTRON™ 6 EXAMINATION GLOVES

For dexterity and tactile sensitivity. Highly resistant to hydrocarbon oils, grease, solvents and detergents. No added proteins causing allergies. Textured grip. Disposable. Powder free. Nitrile. 6 mil. Black.

ORDER NUMBER	DESCRIPTION	UNIT
1 962M	Medium	100/BX
2 962L	Large	100/BX
3 962XL	X-large	100/BX
4 962XX	XX-large	90/BX



✓ **Uses:**
General Purpose
Automotive
Food Handling
Janitorial

D WATSON GLOVES GREASE MONKEY™ DISPOSABLE GLOVES

Exceptionally durable with superior abrasion and puncture resistance. Extended 11" rolled cuff for greater strength and higher wrist protection. CFIS approved. Powder free. Nitrile. 8 mil. Black.

ORDER NUMBER	DESCRIPTION	UNIT
1 5555PF-L	Large	50/BX
2 5555PF-XL	X-Large	50/BX
3 5555PF-XXL	XX-Large	50/BX



✓ **Uses:**
Food Handling
Janitorial
Automotive

E WATSON GLOVES GREEN MONKEY™ GLOVES

Will fully degrade in 10 years in moderate landfill conditions. 4 mil thickness with 9-1 1/2" rolled cuff. Nitrile Powder-free.

ORDER NUMBER	DESCRIPTION	UNIT
1 5559PF-M	Medium	100/BX
2 5559PF-L	Large	100/BX
3 5559PF-X	X-Large	100/BX



F RONCO VITA™ BLUE LINE KNIT GLOVES

Ambidextrous for ease of donning. Can be used as a glove liner. Colour coded knit wrist cuff identifies the size. Poly cotton material. White. 12 pairs/pk.

ORDER NUMBER	DESCRIPTION	UNIT
1 65-010-08	Medium	PK
2 65-010-09	Large	PK

CLEANING, BREAKROOM AND FACILITIES



G ZENITH WALL-MOUNTED WIRE GLOVE DISPENSER

Fully textured ultra gripper tire pattern provides maximum wet and dry grip. Wall-mounting hardware included. White.

ORDER NUMBER	DESCRIPTION	UNIT
1 SGC541	Holds one box, 11"W×4"D×3"H	EA
2 SGC542	Holds two boxes, 11"W×4"D×10 3/4"H	EA



H GLOBE™ DISPOSABLE DELI GLOVES

Use for light-duty tasks that require frequent glove changes. Loose fit for easy on and off applications. Latex free. Powder free. 1.5 mil. Clear.

ORDER NUMBER	DESCRIPTION	UNIT
1 8001	Medium	500/BX
2 8002	Large	500/BX

- ✓ Uses:
Construction
Landscaping
Gardening



A WATSON GLOVES STEALTH LITE SPEED GLOVES

Hard-wearing nitrile coating with nylon seamless knit shell. Lightly textured finish with extended snug-fitting wrist.

ORDER NUMBER	DESCRIPTION	UNIT
1 389-M	Medium	PR
2 389-L	Large	PR
3 389-XL	X-Large	PR

- ✓ Uses:
Construction
Brick Handling
Landscaping
Cut Level AS



B WATSON GLOVES STEALTH DOG FIGHT GLOVES

HPPE composite fibre seamless knit shell. Be safe, be seen with hi-vis safety yellow. Sandy nitrile finish. Ergonomically formed with extended snug fitting knit wrist.

ORDER NUMBER	DESCRIPTION	UNIT
1 357-M	Medium	PR
2 357-L	Large	PR
3 357-XL	X-Large	PR

- ✓ Uses:
Electronics
Automotive
Food Handling
General
Construction



C WATSON GLOVES STEALTH HEAVY ARTILLERY GLOVES

Hi-vis safety orange polyester shell with crinkle latex palm for high touch-sensitivity. Snug-fitting knit wrist.

ORDER NUMBER	DESCRIPTION	UNIT
1 397X6-M	Medium	PR
2 397X6-L	Large	PR
3 397X6-XL	X-Large	PR

- ✓ Uses:
Janitorial
Maintenance
Construction
Fishing
Oil Refinery



D WATSON GLOVES GREEN GLOVES

Strong, durable double dipped PVC coating offers abrasion and chemical resistance. Soft cotton jersey shell absorbs moisture. 12" gauntlet for additional wrist and forearm protection. Textured finish provides a sure grip.

ORDER NUMBER	DESCRIPTION	UNIT
WG12	One size	PR



E FIRST AID CENTRAL® HAND WARMERS

Ready-to-use, safe, natural heat. Air-activated, lasts up to 8 hours.

ORDER NUMBER	UNIT
1 700002	2/PK
2 700002-C	40/BX



F RONCO GRIP-IT™ GLOVES

Excellent general work glove that protects against abrasions, snags and nuisance cuts. Flexible and comfortable for all day wear, they have a natural latex crinkle coating that delivers superb grip and a knitwrist cuff for snug fit. Grey/Blue. 12 pairs/pk.

ORDER NUMBER	DESCRIPTION	UNIT
1 77-500-08	Medium	PK
2 77-500-09	Large	PK

- ✓ Uses:
General Maintenance
Industrial



G RONCO CARE™ SPLIT LEATHER FITTER GLOVES

General maintenance, industrial and warehouse applications. Features a PE safety cuff for added wrist protection. Gunn cut with reinforced finger tips and knuckle strap for added protection. Abrasion and cut resistant. Leather palm and cotton back. Grey with red and blue stripes. 12 pairs/pk.

ORDER NUMBER	DESCRIPTION	UNIT
1 210-09	Large	PK
2 210-10	Extra large	PK

- ✓ Uses:
General Purpose
Automotive
Construction
- Equestrian
Gardening
Landscaping



H WATSON GLOVES FLEXTIME DRYHIDE™ WATER RESISTANT LEATHER GLOVES

Full-grain goatskin leather palm is hard wearing and durable, providing great dexterity. Spandex back provides form-fitting memory. Hooded fingertips and reinforced thumb for additional padding. Snug-fitting elastic wrist with Velcro® closure.

ORDER NUMBER	DESCRIPTION	UNIT
1 005-L	Large	PR
2 005-XL	X-Large	PR
3 005-XXL	XX-Large	PR

Safety – gloves, hard hats and high visibility workwear



A WRANGLER'S™ BY RONCO WINTER HI-VIZ GRAIN LEATHER FITTER

Premium grain leather with 3M Thinsulate lining, Hi-Viz orange nylon back, 3.5" safety cuff, knuckle strap w/ lime green reflective strip and wing thumb.

ORDER NUMBER	DESCRIPTION	UNIT
72-428-10	X-Large	PR



B 3M™ NON-VENTED HARD HAT WITH RATCHET ADJUSTMENT

Non-vented hard hat includes smooth turning 4-point adjustable ratchet suspension that sits lower on the head to reduce pressure points and increase security. Meets the requirements of ANSI/ISEA Z89.1-2009 Type 1, Dielectric Class C, G and E. Meets CSA Z94.1-2005 Type 1, Class C, G and E requirements.

ORDER NUMBER	DESCRIPTION	UNIT
1	CHH-R-W6-PS White	EA
2	CHH-R-Y6-PS Yellow	EA



C 3M™ VENTED HARD HAT WITH RATCHET ADJUSTMENT

Vented hard hat with smooth turning 4-point adjustable ratchet suspension that sits lower on the head to reduce pressure points and increase security. Three height adjustments. Ventilated foam brow pad with cover. Meets ANSI/ISEA Z89.1-2009 Type 1, Class C; and CSA Z94.1-2005 Type 1, Class C requirements.

ORDER NUMBER	UNIT
CHH-V-R-W6-PS	EA

VIKING® SAFETY PRODUCTS FEATURE...

All Viking® products on this page feature high visibility polyester for protection; 2" Vi-Brance® reflective tape within 4" contrasting tape; and dual chest straps.

D VIKING® SAFETY VEST

For conventional job duties that require CSA/ANSI high visibility safety protection. Solid breathable polyester material for added coverage, 5-point tear-away protection. 2" Vi-Brance® reflective material within 4" contrasting tape. Safety D-ring slot access. Dual chest straps and four front pockets. Colours: **O** Orange, **G** Lime Green.



ORDER NUMBER	DESCRIPTION	UNIT
1	6135_-S/M Small/Medium	EA
2	6135_-L/XL Large/X-Large	EA

E VIKING® OPEN ROAD BTE SAFETY VEST

Entry level. Polyester mesh for comfort and breathability. Front Velcro closure. Machine washable. Colours: **O** Orange, **G** Lime Green.



ORDER NUMBER	DESCRIPTION	UNIT
1	6110_-S/M Small/Medium	EA
2	6110_-L/XL Large/Extra Large	EA
3	6110_-2XL/3XL 2XL/3XL	EA

F VIKING® JOURNEYMAN SAFETY T-SHIRT

Non-transparent double-layer polyester fabric for better breathability. Holds colour longer. 2" Vi-Brance® reflective material within 4" contrasting tape provides high visibility protection. Dual chest straps, crew neck style, and left side sealed chest pocket. Colours: **O** Orange, **G** Lime Green.



ORDER NUMBER	DESCRIPTION	UNIT
1	6006_-M Medium	EA
2	6006_-L Large	EA
3	6006_-XL X-Large	EA
4	6006_-XXL XX-Large	EA

G VIKING® SAFETY FLEECE HOODIE

Thermal protective layer. Premium knitted polyester fleece for warmth and breathability. Tearaway detachable hood with drawstring adjusters. Taffeta-lined sleeves. Cell phone pocket and 2 front storage pockets. Colours: **O** Orange, **G** Lime Green.



ORDER NUMBER	DESCRIPTION	UNIT
1	6420J_-M Medium	EA
2	6420J_-L Large	EA
3	6420J_-XL X-Large	EA
4	6420J_-XXL XX-Large	EA

Safety – smoke detectors and fire extinguishers



NEW!

A FIRST ALERT™ CARBON MONOXIDE SENSOR WITH BATTERY BACKUP

Uses an electrochemical carbon monoxide sensor Battery Operated/Plug-in 120 V. Features a silence/test button. Low battery warning. Includes 2 "AA" batteries. 7-year limited warranty. .

ORDER NUMBER	UNIT
SGS342	EA



NEW!

B BRK® IONIZATION SMOKE & CARBON MONOXIDE ALARM

Electrochemical CO sensor. Latching alarm indicator remembers which unit initiated an alarm. End-of-life CO signal. Single test/silence button. Hardwire with 9 volt battery back-up. 10-year limited warranty.

ORDER NUMBER	UNIT
SFV067	EA



NEW!

C FIRST ALERT™ PHOTOELECTRIC SMOKE ALARM

Photoelectric smoke alarm with a 10-year sealed lithium battery. You won't need to worry about battery changes or nuisance beeps due to low batteries, for the entire life of the detector. Low profile, slim design. 85 dB. Easy installation. Alarm status LED indicator. Single test/silence button. End of life warning notifies you when the alarm needs to be replaced. Includes easy twist mount and hardware. 10-year limited warranty.

ORDER NUMBER	UNIT
SGC105	EA

NEW!

D STRIKE FIRST FIRE EXTINGUISHER

ABC type rechargeable extinguisher offers protection against all common classes of fires, including wood, paper, cloth, flammable liquids and electrical fires. Steel cylinder complete with cylinder skirt. Waterproof stainless steel gauge. Full hand grip for ease of operation UCL listed. Includes vehicle bracket. 2.5 lb capacity. 1A:10BC rating. 8' - 10' spray range. 12-14 second discharge time. 150 PSI.



ORDER NUMBER	DESCRIPTION	UNIT
1 SAQ814	4.25 lbs, 3 1/8"D×15 1/2"H	EA
2 SA445	10.5 lbs, 4 1/4"D×16"H	EA

STRIKE FIRST FIRE EXTINGUISHER VEHICLE BRACKET

Standard vehicle bracket for ABC 5 lbs. fire extinguishers. ULC listed. Black polyester powder-coated with stainless steel strap.

3 SC955	EA
---------	----



E FIRST AID CENTRAL® SAFETY SIGNS

Chemical, abrasion and moisture-resistant signs. "L" shape projects 90° from wall. 5 1/2"W×8"D×2"H.

ORDER NUMBER	DESCRIPTION	UNIT
1 900110	AED/DEA	EA
2 900102	Fire Hose	EA
3 900100-G	Fire Extinguisher	EA
4 900101	First Aid	EA



F HEADLINE® GLOW IN THE DARK SIGNS

Highly visible glow in the dark signs. Durable and tear resistant.

ORDER NUMBER	DESCRIPTION	UNIT
1 10736-04792	Exit, 8"×12"	EA
2 10736-04793	Fire Extinguisher, 4"×13"	EA



G HEADLINE® OSHA SAFETY SIGNS

Improve workplace safety with OSHA-compliant safety signs. UV, chemical, abrasion and moisture resistant. Constructed of rigid .060" styrene. 10"×14".

ORDER NUMBER	DESCRIPTION	UNIT
1 10736-05492	Notice Authorized Personnel Only	EA
2 10736-05484	Danger No Smoking	EA
3 10736-05491	Danger Keep Out	EA
4 10736-05494	Caution Slippery When Wet	EA

Fans and Heaters



A ROYAL SOVEREIGN® 2-IN-1 CLIP-ON DESK FAN

Offers the versatility of both a clip-on and compact desk fan. Conveniently snaps into base to convert to a desk fan. Two speed settings. Tilt adjustable head. 360 degree swivel. 6". White. 7.7"W×8.3"D×11.8"H.

ORDER NUMBER	UNIT
DFN-15	EA



NEW!

B ROYAL SOVEREIGN® OSCILLATING DESK FAN

Tilt adjustment and 3 speeds.



ORDER NUMBER	DESCRIPTION	UNIT
1 DFN-1012B	12"	EA
2 DFN-1016B	16"	EA

NEW!

C ROYAL SOVEREIGN® TOWER FAN WITH TIMER

Ideal for cooling large areas while taking up little floor space. Slim tower design with wide area oscillation. 3 fan speeds.

ORDER NUMBER	DESCRIPTION	UNIT
1 TFN-1029B	29" High	EA
2 TFN-1036B	36" High with Remote Control	EA



NEW!

D ROYAL SOVEREIGN® OSCILLATING PEDESTAL FAN

Compact 16" pedestal fan with adjustable tilt and height. 3 fan speed settings and optional oscillation.

ORDER NUMBER	UNIT
PFN-1016B	EA



F ROYAL SOVEREIGN® HIGH VELOCITY OSCILLATING PEDESTAL FAN

Medium-sized high velocity 5800 CFM pedestal fan with powerful airflow. Ideal for warehouses, factories and other large spaces. Powerful and portable with 3 speed selections, 55° oscillating wide area air circulation, 45° tilt and 42"-56" adjustable height. Black. 21.6"W×21.6"D×57"H.

ORDER NUMBER	UNIT
PFNC-20SE	EA



E ROYAL SOVEREIGN® HIGH VELOCITY DRUM FAN

All metal construction and built-in wheels for easy mobility. cULus safety certified. 1/3 HP motor with ball bearings. 7855 CFM. 3 fan speeds. 180° tilt adjustable. 24" diameter. Black. 29.6"W×8.9"D×29.8"H.

ORDER NUMBER	UNIT
RACC-HV24SE	EA

CLEANING, BREAKROOM AND FACILITIES

**A ROYAL SOVEREIGN®
3-IN-1 PORTABLE AIR
CONDITIONER**

Unit combines an air conditioner to cool, fan to circulate air and dehumidifier to remove moisture. 8000 BTU (5300 BTU SACC) air conditioner ideal for a room up to 300 sq.ft. Front, manual 4-way louvers allow user to set desired air flow direction. Washable air filter helps prevent bacteria and mold growth. LED digital display control panel or remote control for convenient operation. 24 Hour timer and convenient sleep and lock function. Window kit included for quick and easy set up.



ORDER NUMBER	DESCRIPTION	UNIT
ARP-2208	11.8"W×12"D×27.6"H	EA

**B ROYAL SOVEREIGN®
HEAVY DUTY UTILITY HEATER**

All metal body and base and long life, PTC (ceramic) heating element. Ideal for garages, workshops and worksites. 2 Heat Settings, 750/1500W. Fast 3 second heat generation and high air output for effective space heating (197 m3/h). Manual adjustable thermostat and fan only setting. Adjustable tilt. Yellow and black. cETL certified.



ORDER NUMBER	DESCRIPTION	UNIT
HUT-80	8.6"W×8.7"D×10.3"H, 4.4 lbs.	EA

**C ROYAL SOVEREIGN®
COMPACT FAN/HEATER**

Compact economical heater with 2 heat settings and fan only setting for multi-seasonal use. Easy to use manual thermostat will help maintain your desired comfort level. Built in safety features for peace of mind.



ORDER NUMBER	DESCRIPTION	UNIT
HFN-03	8.3"W×5.5"D×10.5"H	EA

**D ROYAL SOVEREIGN®
COMPACT CERAMIC HEATER**

Lightweight compact heater provides safe ceramic warmth. Great for desktop or floor use with quiet heat or fan-only settings. Features 750W/1500W heat settings. Cool/warm/hot mode selections. Adjustable room thermostat, automatic temperature control, overheat protection. Safety tip-over switch. CETL certified. 1 year warranty.



ORDER NUMBER	DESCRIPTION	UNIT
HCE-100	7.1"W×5.5"D×8.3"H	EA



**E ROYAL SOVEREIGN®
OSCILLATING CERAMIC
HEATER**

Quiet heat or fan-only settings for year round continuous use. Features 750W/1500W heat settings, oscillation, cool/warm/hot mode selections. Safety tip over switch and an automatic temperature control.

ORDER NUMBER	DESCRIPTION	UNIT
HCE-160	7.9"W×5.9"D×10.2"H	EA

**F ROYAL SOVEREIGN®
CERAMIC
TOWER
HEATER**

Provides fast, safe ceramic space heating. Easy-to-use top-mounted controls to help maintain your desired comfort level. Two heat settings and a fan-only setting for year-round use. Adjustable room thermostat, overheat preventions and top-over switch. Wide angle oscillation and a washable dust filter.



ORDER NUMBER	DESCRIPTION	UNIT
HFN-50D	19"H	EA

NEW!

**G ROYAL SOVEREIGN®
DIGITAL OSCILLATING HEATER**

24-hour timer and safety features for peace of mind. Overheat protection and safety tip-over switch. Adjustable thermostat displays set temperature and room temperature. Two heat settings (750W/1500W), and energy efficient Auto Mode that automatically adjusts heat output to room surrounding until the set temperature is reached.

ORDER NUMBER	DESCRIPTION	UNIT
HFN-50D	8 1/8"W×5 7/10"D ×11 5/8"H	EA



Floor Mats

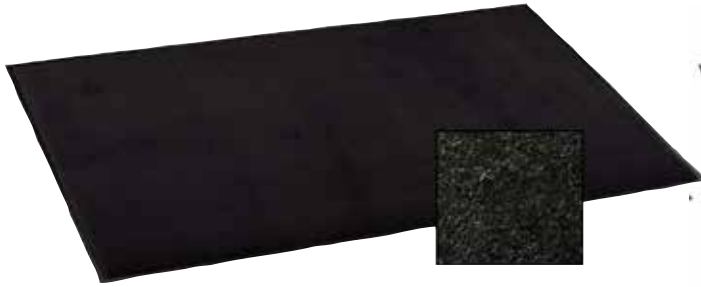

A FLOORTEX® PROPLUSH WIPER MAT

Attracts and traps dirt, dust, moisture and oil from shoes. The $\frac{3}{8}$ " thick Olefin fibre surface provides exceptional durability and resistance to fading. The heavy-duty vinyl backing prevents curling and slippage. Ideal for medium-high traffic areas. Black.

ORDER NUMBER	DESCRIPTION	UNIT
1 FECOL3660B	36"×60"	EA
2 FECOL4872B	48"×72"	EA

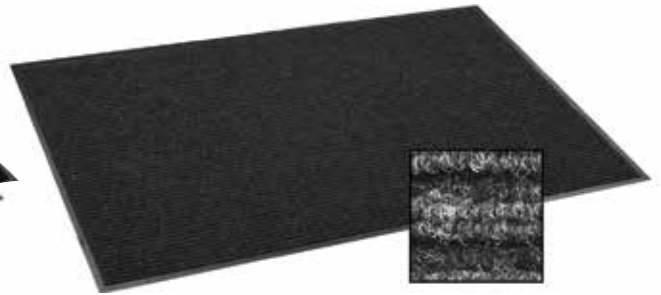

B FLOORTEX® ECO RUNNER WIPER/SCRAPER MAT

Constructed from a durable blended PET/Polypropylene surface sourced from a minimum of 60% recycled PET fibres, the mat is ribbed to help remove dirt, salt and snow. The $\frac{3}{8}$ " pile top absorbs oil and moisture to help prevent slips and falls. Recommended for indoor use in medium-high traffic areas. Charcoal.

ORDER NUMBER	DESCRIPTION	UNIT
1 FECRR3660CH	36"×60"	EA
2 FECRR4872CH	48"×72"	EA

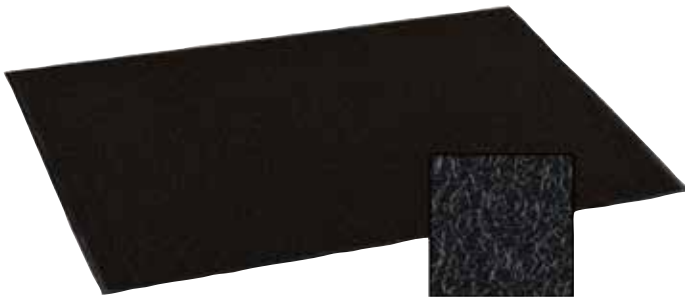

C FLOORTEX® LICHEN SCRAPER MAT

The durable organic-look looped vinyl surface removes and traps salt, mud and debris from footwear. The heavy-duty phthalate-free PVC backing ensures that your mat stays just where you want it while catching dirt and moisture. Easy to clean - just hose it off and let it dry. Black.

ORDER NUMBER	DESCRIPTION	UNIT
FLICA3648B	36"×48"	EA



D FLOORTEX® BUBBLE ANTI-FATIGUE MAT

Fatigue relief in light to medium duty areas, food service counters, packaging stations and bars. Air pockets under sealed surface help to provide muscle and joint relief when standing for extended periods. Durable rubber surface can withstand damage from stools, high-heels and carts. 1/2" thick. 1-year warranty. Black.

ORDER NUMBER	DESCRIPTION	UNIT
FBUBB2436B	24"×36"	EA



E FLOORTEX® INDUSTRIAL CUSHION ANTI-FATIGUE MAT

For medium to heavy duty locations. Deck plate vinyl surface fused to industrial grade PVC foam for comfort and relief. Resistant to most common fluids and chemicals 30% recycled material. $\frac{1}{2}$ " thick.

ORDER NUMBER	DESCRIPTION	UNIT
FICUS2436B	24"×36", Black	EA



F FLOORTEX® CUSHION MAT

The Cushion Mat features a puncture-resistant vinyl surface offering stability, traction and durability. Fatigue relief in medium to heavy applications. The marble patterned surface is easy to maintain and clean. $\frac{1}{2}$ " thick. Black.

ORDER NUMBER	DESCRIPTION	UNIT
FCSTP2436B	24"×36"	EA

A FLOORTEX® AFS-TEX SYSTEM 2000X ANTI-FATIGUE MATS

Premium anti-fatigue mat designed to improve comfort when standing for long periods. Actively encourages micro-movements for additional fatigue-relief. Raised massage pods and calf stretch area provides stimulation and relieve pressure on the feet. Built-in anti-microbial agent. Easy to wipe clean. Anti-slip base. Black fine-weave polyester cover. Colours **BK** Black, or **GY** Grey.



ORDER NUMBER	DESCRIPTION	UNIT
1 FCA21624X	16"×24"	EA
2 FCA22032X	20"×32"	EA

B FLOORTEX® EASY FOOT ANTI-FATIGUE MATS

For light duty areas including service counters, mailrooms, cashier and packaging stations. The closed cell PVC sponge optimizes economical comfort and fatigue relief. Slip-resistant surface. 3/8" thick. Black.



ORDER NUMBER	DESCRIPTION	UNIT
1 FEAFM2436B	24"×36"	EA
2 FEAFM3660B	36"×60"	EA



C ZENITH® ANTI-FATIGUE DOME MATS

Designed to help prevent injuries and increase worker comfort. Raised dome design increases circulation in the user's legs through subtle posture changes resulting in less stress. Recommended for dry work environments. Bevelled safety edges. 1/2" thick natural rubber.

ORDER NUMBER	DESCRIPTION	UNIT
SINGLE MAT		
1 SDL857	2'W×3'L, Black	EA
2 SDL858	2'W×3'L, Black and Safety Yellow	EA
3 SDL859	3'W×4'L, Black	EA
4 SDL862	3'W×4'L, Black and Safety Yellow	EA
MODULAR MAT 3'W×4'L		
5 SDL860	Centre, Black	EA
6 SDL863	Centre, Black and Safety Yellow	EA
7 SDL861	End, Black	EA
8 SDL864	End, Black and Safety Yellow	EA

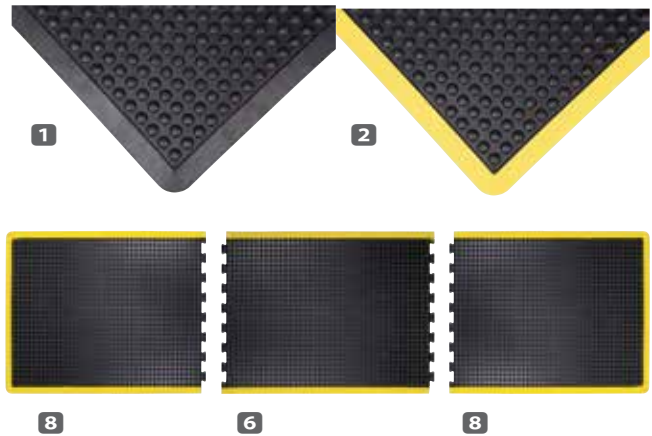

D SCOTCH™ FELT PADS

Equipped with powerful adhesive and durable felt, these floor protectors adhere effortlessly to the legs of your furniture and provide long-lasting protection from gouges and scratches.

ORDER NUMBER	DESCRIPTION	UNIT
SP842-NA	Assorted sizes, Beige	36/PK



E SCOTCH™ SELF-STICK RUBBER BUMPERS

Soften the slam of a door or drawer with the quieting power of Scotch™ Bumpers. They're also great for ensuring your framed art hangs flush against your walls or adhering to the bottom of coasters to protect your surfaces.

ORDER NUMBER	DESCRIPTION	UNIT
SP950-NA	1/2" Clear	20/PK



F DOOR STOP WEDGES

Grip both floor and door to keep the door open.

ORDER NUMBER	DESCRIPTION	UNIT
1 78012	Fits 3/4" gap	2/PK
2 1020-9470-00-000	Fits 2" gap	EA
3 1020-9470-90-000	Fits 2" gap, orange	EA

Facility Supplies – waste containers



A RUBBERMAID® WASTEBASKET

Space-efficient and economical. Fits under standard desk. Rolled rims add strength. Easy to clean. 12.9 L, 11 $\frac{3}{8}$ "W×8 $\frac{1}{4}$ "D×12 $\frac{1}{2}$ "H.

ORDER NUMBER	DESCRIPTION	UNIT
FG295500BLA	Black	EA



D GLOBE™ STEP-ON STREAM WASTE/RECYCLE CAN

Waste and recycling in one convenient step-on can. Lid helps keep odours in check. Removable cans with convenient handles. Two 26 L cans. 13 $\frac{1}{2}$ "W×10 $\frac{1}{2}$ "D×16"H

ORDER NUMBER	UNIT
9600	EA



G GLOBE™ STEP-ON WASTE CONTAINER WITH SOFT CLOSE LID

Aesthetically pleasing stainless steel finish. Soft close lid allows you to remove your foot quickly. Removable liner with handle for ergonomic collection. 20 L. 12 $\frac{1}{2}$ "W×16 $\frac{3}{8}$ "D×17 $\frac{1}{2}$ "H Stainless Steel with Black lid.

ORDER NUMBER	UNIT
9683	EA



B STOREX® WASTEBASKETS

Washable all-plastic construction will not rust, dent or chip. Contains 100% post-consumer recycled material.

ORDER NUMBER	DESCRIPTION	UNIT
14 $\frac{1}{2}$ "W×10 $\frac{1}{4}$ "D×15"H		
1 00710U06C	26 L, Black	EA
15 $\frac{1}{2}$ "W×11"D×20 $\frac{3}{4}$ "H		
2 00700U04C	39 L, Black	EA



E SAFCO® ROUND METAL WASTEBASKET

Puncture-resistant, solid-ribbed steel construction with a rolled wire rim top for added strength. Features 1" recessed bottom. UL classification fire resistance. Powder coat finish. Black. 22.2 L 13"W×14"H

ORDER NUMBER	UNIT
9604BL	EA



✓ **SEPARATE**
trash at source

C RUBBERMAID® SIDE BIN WASTEBASKET

Segregate trash at the source. Fits most regular, desk-side wastebaskets. 12.9 L. 10 $\frac{1}{2}$ "W×7 $\frac{1}{4}$ "D×11 $\frac{1}{2}$ "H.

ORDER NUMBER	DESCRIPTION	UNIT
FG295073BLA	Black	EA



F WINNABLE® MESH WASTEBASKETS

Add a clean, distinctive look to any office. Mesh enamelled wire. Black.

ORDER NUMBER	DESCRIPTION	UNIT
1 14533	10 $\frac{1}{2}$ "W×10 $\frac{1}{2}$ "D×14"H	EA
2 12351	11 $\frac{1}{2}$ "Dia.×13 $\frac{3}{4}$ "H	EA



H SAFCO® PLASTIC STEP-ON RECEPTACLE

Sized to easily slide under desks, sinks and between small office spaces. Hands-free operation – lid automatically closes. Greenguard certified. 4 gallons. 12 $\frac{1}{4}$ "W×10"D×15"H.

ORDER NUMBER	DESCRIPTION	UNIT
9710BL	Black	EA



I PLASTIC SWING TOP RECEPTACLE

Pivoting lid allows hands free disposal of trash. 13 L. Dimensions: 9 $\frac{1}{16}$ "W×9 $\frac{1}{16}$ "D×15 $\frac{1}{8}$ "H.

ORDER NUMBER	DESCRIPTION	UNIT
8012GY	Grey	EA



A RUBBERMAID® UNTOUCHABLE® CONTAINER

Durable and crack-resistant, even under tough indoor/outdoor conditions. Square. 15½"W×16½"D×30¾"H. 87.1 L. Black.

ORDER NUMBER	DESCRIPTION	UNIT
1 FG356988BLA	87.1 L	EA
2 FG268988BLA	Swing top lid	EA



B RUBBERMAID® SLIM JIM® WASTE CONTAINERS

Efficient size and shape designed to fit tight spaces. Durable all-plastic construction is easy to clean. Features bottom hand-holds for a secure grip during emptying. 22"W×11"D×30"H. 87.1 L. Grey.

ORDER NUMBER	DESCRIPTION	UNIT
1 FG354060GRAY	87.1 L	EA
2 FG268888LGRAY	Dome top lid with handle	EA
3 FG267360GRAY	Swing lid	EA



C RUBBERMAID® BRUTE® CONTAINER

Innovative venting channels make removing liners up to 50% easier. Integrated cinches secure can liners, meaning knot-free liner changes. Contoured base handles improve grip, reduce strain and improve efficiency when emptying containers. 21½" Diameter×27¾"H. Grey.

ORDER NUMBER	DESCRIPTION	UNIT
1 FG263200GRAY	121.1 L Waste Container Lids	EA
2 FG263100GRAY	Snap-on lid	EA
3 FG263788GRAY	Dome top lid	EA
4 FG264000BLA	Dolly	EA



D GLOBE™ STEP-ON BINS

Heavy-duty plastic step-on for any commercial application. Lid helps keep odours in check and is more aesthetically pleasing to the eye. Large pedals to accommodate all shoe sizes.

ORDER NUMBER	DESCRIPTION	UNIT
1 9673	45 L, 17"W×15"D×23"H	EA
2 9674	68 L, 20"W×16½"D×26"H	EA



E GLOBE CADDY BAG FOR ROUND CONTAINERS

Convert garbage cans into mobile cleaning stations. Multiple sized pockets to organize cleaning supplies of all types. Durable, easy-to-clean vinyl. Straps on and off easily for quick conversion. Fits the 20 Gallon, 32 Gallon and 44 Gallon Sizes. 20"×20 ½".

ORDER NUMBER	DESCRIPTION	UNIT
9605	Yellow	EA



F RUBBERMAID® BRUTE® ROLLOUT WASTE CONTAINER WITH LID

Attached hinged lid fits tightly, swings back and locks. Tough Dur-x™ construction lends long life. Rounded corners and smooth contours are easy to clean. Heavy duty 8" wheels and molded-in axle retainer. 189.3 L. 30¾"L×24"D×39¾"H.

ORDER NUMBER	DESCRIPTION	UNIT
FG9W2700GRAY	Grey	EA

CLEANING, BREAKROOM AND FACILITIES



A RUBBERMAID® RECYCLING BASKET

An easy and effective way to recycle paper. 11½"W×8¼"D×12½"H. Blue. 12.9 L

ORDER NUMBER	UNIT
FG295573BLUE	EA



B STOREX® RECYCLING BIN

Ideal for deskside use. Washable all-plastic construction will not rust, dent or chip. Contains 100% post-consumer recycled material. Blue.

ORDER NUMBER	DESCRIPTION	UNIT
1 61505U06C	Letter size, 9"W×11½"D×8"H	EA
2 61517U06C	Legal size, 11½"W×17"D×8¼"H	EA



C RUBBERMAID® SLIM JIM® CONTAINER

For use in areas of high paper generation – near copiers, printers and mailrooms. 22"W×11"D×30"H. Blue.

ORDER NUMBER	DESCRIPTION	UNIT
1 FG354007BLUE	87.1 L	EA
2 1788372	Lid for mixed	EA
3 FG270388BLUE	Lid for paper	EA



D STOREX® RECYCLING BASKET

Household or office recycling basket made of durable plastic that will not crack or dent. 26.4 L. 15"W×10½"D×15"H

ORDER NUMBER	UNIT
00714U06C	EA



E STOREX® LARGE CAPACITY DESKSIDE RECYCLING CRATE

Made with 25% post-consumer material. Comfort grip handles. Dimensions: 18"L×13.5"D×10.5" H. 35 L

ORDER NUMBER	UNIT
61549U06C	EA



G RUBBERMAID® UNTOUCHABLE® SQUARE RECYCLING CONTAINER

Station containers provide convenient central collection sites for multiple work stations and areas. Can liner cinch holds the bag in place, eliminating knot tying. 87.1 L. 15½"W×16½"D×30¾"H. Blue.

ORDER NUMBER	DESCRIPTION	UNIT
FG356973BLUE	87.1 L	EA



F GLOBE™ BATTERY COLLECTION BIN

Quick drop hole allows for effortless collection of batteries without having to open the lid. Countertop size means it can accommodate a variety of collection locations. Features a carrying handle. 2 Gallon. Black and Orange.

ORDER NUMBER	UNIT
9309	EA

Facility Supplies – waste containers



A RUBBERMAID® SLIM JIM® RECYCLING STATION KITS

Simple and durable recycling station kits are easy to use with no hardware needed. Just snap together. Includes labels and placecards. (English only).

ORDER NUMBER	DESCRIPTION	UNIT
1 2007914	2-Stream, Landfill/Mixed Recycling	EA
2 2007917	3-Stream, Landfill/Paper/Bottles & Cans	EA

B RUBBERMAID® BRUTE® ROLLOUT RECYCLING CONTAINER WITH LID

Transport recyclable waste with ease and efficiency. Heavy-duty wheels roll easily, even over steps or curbs. 189.3 L. 30 3/8"W×24"D×39 3/8"H.

ORDER NUMBER	DESCRIPTION	UNIT
FG9W2773BLUE	Blue	EA



C GLOBE™ WASTE CONTAINER

Sturdy and durable plastic to withstand daily use in commercial environments. Ideal for industrial, food service, automotive, office and healthcare use. Features rugged ergonomic handles. Pairs perfectly with waste container lids. 20"W×20"D×23 1/2"H. Blue.

ORDER NUMBER	DESCRIPTION	UNIT
1 9620B	91 L	EA
2 9621B	Snap-lock lid	EA



D SAFCO® SQUARE SANDLESS ASH AND TRASH RECEPTACLE

Outdoor trash can and ash urn. Black steel with chrome accents. Sandless ash urn with slotted snuffer. Greenguard certified. 3 gallon capacity. 9 1/2"W×9 1/2"D×24 1/4"H.

ORDER NUMBER	UNIT
9696BL	EA



E RUBBERMAID® TUSCAN SMOKING RECEPTACLE

Inner galvanized steel canister securely holds large quantities of cigarette waste. Two-piece design makes cleaning quick and easy. Restricted opening shields cigarette butts from view, weather, and flow of oxygen. 12 1/2"W×12 1/2"D×39 3/4"H. Black.

ORDER NUMBER	UNIT
FG9W3000BLA	EA

CLEANING, BREAKROOM AND FACILITIES

Freight charges may apply. Check online for the most current price.

Facility Supplies – garbage bags



A RALSTON 2600 SERIES ECOLOGO™ INDUSTRIAL GARBAGE BAGS

Economical and a lighter gauge. Recycled plastics are collected and used from household blue box programs as well as post industrial-use materials. Contains a minimum of 10% post-consumer recycled material.

ORDER NUMBER	DESCRIPTION	UNIT
SUPER STRONG, BLACK		
1 2697-01	42"×48"	50/CT
EXTRA STRONG, BLACK		
2 2681-01	26"×36"	125/CT
3 2683-01	30"×38"	125/CT
4 2685-01	35"×50"	100/CT
5 2687-01	42"×48"	75/CT
STRONG, BLACK		
6 2671-01	26"×36"	200/CT
7 2673-01	30"×38"	200/CT
8 2675-01	35"×50"	125/CT
9 2677-01	42"×48"	100/CT
REGULAR, BLACK		
10 2652-01	20"×22"	500/CT
11 2654-01	22"×24"	500/CT
12 2661-01	26"×36"	250/CT
13 2663-01	30"×38"	250/CT
14 2665-01	35"×50"	200/CT
15 2667-01	42"×48"	125/CT



B RALSTON 2900 SERIES ECOLOGO™ INDUSTRIAL GARBAGE BAGS

Made with a virgin rich post-industrial and consumer resin blend. This allows for significant downgauging while still delivering superior performance and reducing the amount of plastic going into landfill. Contains a minimum of 10% post-consumer blue box recycled resin.

ORDER NUMBER	DESCRIPTION	UNIT
EXTRA STRONG, CLEAR		
1 2985-00	35"×50"	100/CT
2 2987-00	42"×48"	75/CT
STRONG, CLEAR		
3 2973-00	30"×38"	200/CT
4 2975-00	35"×50"	125/CT
STRONG, BLUE		
5 2971-08	26"×36"	200/CT
6 2975-08	35"×50"	125/CT
REGULAR, CLEAR		
7 2952-00	20"×22"	500/CT
8 2954-00	22"×24"	500/CT
9 2961-00	26"×36"	250/CT
10 2963-00	30"×38"	250/CT
11 2965-00	35"×50"	200/CT
REGULAR, WHITE		
12 2952-10	20"×22"	500/CT
13 2953-10	22"×20"	500/CT



High Density Frosted



C RALSTON 2800 SERIES HIGH DENSITY INDUSTRIAL GARBAGE BAGS

Made from quality high density resins. These bags have exceptional strength and are ideal for heavy, wet garbage.

ORDER NUMBER	DESCRIPTION	UNIT
REGULAR, FROSTED		
1 2865-90	36"×50", 13 microns	250/CT
UTILITY, FROSTED		
2 2832-90	20"×22", 8 microns	1000/CT



D RALSTON SUPERSAK® CONTRACTOR GARBAGE BAGS

Black garbage bags in a dispenser carton. Bags are perforated for easy tearoff. 33"×48". 3 mil. 15 bags/roll. 2 rolls/ct.

ORDER NUMBER	UNIT
379-01	30/CT



CLEANING, BREAKROOM AND FACILITIES



E RALSTON SUPERSAK™ KITCHEN GARBAGE BAGS

20"×21". White.

ORDER NUMBER	UNIT
401-10	48/RL



F RALSTON SUPERSAK™ GARBAGE BAGS

26"×32½". Black.

ORDER NUMBER	UNIT
404-01	20/RL

COMPOSTABLE
REDUCE OUR FOOTPRINT



G RALSTON BIOSAK® COMPOSTABLE BAGS

ORDER NUMBER	DESCRIPTION	UNIT
KITCHEN ORGANICS		
1 050303	17½"×16¾"	20/BX
GREEN BIN LINERS		
2 050603	25"×30"	10/BX

Facility Supplies – garbage bags and pest control



A GLAD® WHITE GARBAGE BAGS

Ready and prepared to handle all your garbage, this bag suppresses the worst trash odours. And with the Easy-Tie closure you just tie, grab, toss, and you're done. Ideal for kitchen, bathroom, bedroom or office.

ORDER NUMBER	DESCRIPTION	UNIT
1 67489-10299	17"×20", X-Small	52/BX
2 67489-30219	20"×20", Small	48/BX
3 67489-30220	20"×20", Small	100/BX
4 67489-30221	24"×28", Tall	30/BX
5 67489-30279	24"×28", Tall	60/BX



B GLAD® BLACK GARBAGE BAGS

Easy-Tie bags have four flaps designed for easy closing, making even the fullest bags simple to lift and carry. 31"×42" X-Large.

ORDER NUMBER	DESCRIPTION	UNIT
1 67489-70512	Black	20/BX
2 67489-11592	Clear	20/BX



C GLAD® BLUE RECYCLING BAGS WITH FORCEFLEX®

The unique Forceflex® Diamond Texture stretches with your trash to prevent rips and tears so you can recycle more without the spills or messy clean up. Drawstring closure.

ORDER NUMBER	DESCRIPTION	UNIT
67489-30301	24"×28" Tall, 45 L	50/BX

✓ **COMPOSTABLE**
REDUCE OUR FOOTPRINT

D GLAD® COMPOST BAGS

Glad 100% Compostable Fresh Lemon Scent bags keep your bin smelling fresh and are certified compostable. Features Febreze lemon freshness.

ORDER NUMBER	DESCRIPTION	UNIT
1 12587-78162	16"×17"	20/BX
2 12587-78163	24"×31"	10/BX



E RAID® WASP & HORNET BUG KILLER

Kills on contact. Sprays from 4 metres away.

ORDER NUMBER	DESCRIPTION	UNIT
1 62300-01776	400g	EA

RAID® HOME INSECT KILLER

Kills flies, mosquitoes, fleas, flying moths, gnats, spiders, bed bugs, sowbugs, carpet beetles, centipedes, ants, silverfish and wasps on contact.

2 62300-70444	350g	EA
---------------	------	----

RAID® ANT, ROACH & EARWING INSECT KILLER

No lingering odour. Kills fleas, spiders, centipedes, bed bugs, silverfish, and crickets on contact.

3 62300-01725	350g	EA
---------------	------	----



H OFF!® DEEP WOODS® INSECT REPELLENT

Provides long-lasting repellency against biting insects, (disease carrying ticks, mosquitoes, black flies, sand flies, chiggers, fleas and gnats), up to 8 hours. Ideal for heavily wooded areas. Contains 25% DEET.

ORDER NUMBER	DESCRIPTION	UNIT
PUMP SPRAY		
1 62300-01856	30 ml	EA
AEROSOL		
2 62300-71944	230g	EA
WIPES		
3 62300-00262	Deet Free	10/PK



F RAID® ANT BAITS

Kill ants where they hide. The baits fit snugly in corners and along ant trails. Raid® Ant Baits are child-resistant. For indoor use.

ORDER NUMBER	UNIT
62300-71893	4/PK

G OFF!® FAMILYCARE® INSECT REPELLENT

Contains aloe vera and repels mosquitoes for three hours. Summer Splash®. Pump spray.

ORDER NUMBER	DESCRIPTION	UNIT
62300-01938	175 ml	EA



CLEANING, BREAKROOM AND FACILITIES

Freight charges may apply. Check online for the most current price.



A ICE MELT

Premium blend melts to extreme temperatures and resists re-freezing. Fast acting and sure-grip in extreme conditions. 5 kg.



ORDER NUMBER	UNIT
8347898	EA

NEW!

C MELTCO PREMIUM ECO-FRIENDLY DE-ICER

100% natural. Enhanced with MCI3 for safe, optimum performance. Child & pet friendly choice. No nitrogen or phosphorus added. Melting point -25°C (-15°F). Ideal for spreading – gentle on vegetation, and safer for concrete, asphalt, sidewalks and pavers. Biodegradable green colour indicator. 22.68 kg.



ORDER NUMBER	UNIT
N0413	EA



E SALT AND STORAGE CONTAINER

Thick-walled, durable poly construction. Double-walled reinforced lid. Weather resistant, corrosion free. Molded forklift channels and recessed hand holes. 500 lb capacity. 30"W x 24"D x 24"H.

ORDER NUMBER	DESCRIPTION	UNIT
1 GP500/#4	Grey	EA
2 STORALL500-YLW	Yellow	EA
2 2315160	Salt Scoop	EA

B NYLITE CANADA FLAGS

The most popular and versatile outdoor flags. NyLite 70 denier nylon flags offer the optimal combination of elegance and durability. (Government specified fabric).

ORDER NUMBER	DESCRIPTION	UNIT
ROPE AND TOGGLE		
1 34-005427T	54"×27"	EA
2 34-007236T	72"×36"	EA
OUTDOOR FLAG POLE KIT		
3 42-600100	6'	EA

D STOREX® SCHOOL LOCKER/OFFICE CUBICLE BOOT TRAY

Just the right size for school lockers or office cubicles. Integrated gutter flows water and dirt away from shoes. 11"×12". Black.



ORDER NUMBER	UNIT
00802B18S	EA



F STOREX BOOT TRAY

Keeps dirt and moisture away from floors and carpets. Built in gutter collects water and dirt to keep it away from footwear. Minimum 30% recycled. 27"L×14"W×1½"H.

ORDER NUMBER	DESCRIPTION	UNIT
00800U06C	Black	EA

CLEANING, BREAKROOM AND FACILITIES



G MALLORY® SNOW BRUSH

Wood handle snow brush. Black/beige.

ORDER NUMBER	UNIT
203	EA



H MALLORY® LONG REACH SNOW BRUSH

Aluminum handle with large foam grip and unbreakable blade. 35" long. Red.

ORDER NUMBER	UNIT
889-35	EA

NEW!

I TURBO POWER™ ALL-SEASON WINDSHIELD WASHER FLUID

Specially developed methanol based fluid designed to provide excellent grime, salt and snow cleaning performance in most weather conditions. Non-smear formulation. Protects windshields in temperatures down to -40°C. 3.78 L.



ORDER NUMBER	UNIT
AD458	EA



A GARANT® ALPINE™ SNOW SHOVELS

Polypropylene blade with wear strip. D-grip handle. Yellow.

ORDER NUMBER	DESCRIPTION	UNIT
46 1/4" STAINED ASH WOOD HANDLE		
1 APP21KDR	20 3/4" blade	EA
42 1/4" STAINED ASH WOOD HANDLE		
2 APP26KDR	26" blade	EA

B GARANT® PRO™ SNOW SHOVEL

Polypropylene blade with D-grip handle. 45" Stained Ash Wood handle. 13 3/8". Black.

ORDER NUMBER	UNIT
NE314	EA

C AURORA TOOLS® SNOW SCOOP

Polypropylene blade. 19 3/4"W x 54 3/4"H. Black.

ORDER NUMBER	UNIT
NM810	EA

D AURORA TOOLS® SNOW PUSHERS

Powder-coated steel handle and plastic blade with wear strip. 21 1/4"W x 51 1/2"H. Black.

ORDER NUMBER	UNIT
NM812	EA



E AURORA TOOLS® STANDARD DUTY LANDSCAPING SHOVELS

Durable fibreglass handle with rubber grip. Forward turned step for extra strength.

ORDER NUMBER	DESCRIPTION	UNIT
ROUND BLADE, D-GRIP HANDLE		
1 NJ093	11" x 8 1/2" blade, 32 1/2" L	EA
ROUND BLADE, STRAIGHT HANDLE		
2 TLZ465	11" x 8 1/2" blade, 56" L	EA
SQUARE BLADE, D-GRIP HANDLE		
3 NJ094	11 1/2" x 8 1/2" blade, 32 1/2" L	EA
SQUARE BLADE, STRAIGHT HANDLE		
4 NJ095	11 1/2" x 8 1/2" blade, 56" L	EA





FEATURE

A MOTOROLA TALKABOUT™ T210 SERIES TWO-WAY RADIOS

Fully featured, tough and stylish walkie-talkie is the ideal way to stay connected during outdoor adventures. The easy pairing button makes setup a breeze. Features USB charging, 22 channels with 121 privacy codes and up to 32 km range with no call charges.



ORDER NUMBER	UNIT
SGW761	PK



B EMZONE SPORT AIR HORN

Signal produces a loud blast. Ideal for boats, construction sites, industrial use, and sporting events. 120 decibel volume can be heard over a mile away. 156g / 5.5 oz.



ORDER NUMBER	UNIT
60480-46400	EA

C KLETON® POLYETHYLENE TARPULINS

Water resistant coating, with reinforced polypropylene rope sewn into welded hems for increased UV resistance and longer life. Heavy Duty. Features heavy-duty rust-resistant grommets every 36". 10"×10" weave density with reinforced corner patches. 6 mil, White.



ORDER NUMBER	DESCRIPTION	UNIT
1 NN385	6' x 8'	EA
2 NN386	8' x 10'	EA
3 NN387	10' x 12'	EA
4 NN388	12' x 16'	EA
5 NN389	16' x 20'	EA
6 NN390	18' x 24'	EA
7 NN391	20' x 30'	EA

D KLETON® FURNITURE PADS

Protects furniture from scratches when moving. Zig-zag stitching provides durability. Cotton and polyester material. 72"W×80"L. Premium. 40 oz, 5½ lbs, Dark & Light Blue.



ORDER NUMBER	UNIT
PF460	EA

CLEANING, BREAKROOM AND FACILITIES

NEW!

E BIOS IA006 DIGITAL STOP WATCH

High contrast digital display with backlight. Shock and water-resistant. Records split times for accurate results. Clock, date and alarm functions. Remembers first 30 laps and their split times (max. 99 laps displayed). 1/100th second resolution up to 100 hours. Requires LR1130 battery (included) and a 23" lanyard.



ORDER NUMBER	UNIT
FP600	EA

NEW!

F BIOS IA078 DIGITAL STOP WATCH

Large LCD that displays real time and records split times for accurate results. Water-resistant. Features clock, date and alarm function. Remembers first 30 laps and their split times (max. 99 laps displayed). 1/100th second resolution up to 100 hours. Requires CR2032 battery (included) and a 48" lanyard.



ORDER NUMBER	UNIT
FP603	EA

NEW!

G ZENITH® COLOURED CONE

One-piece lightweight PVC construction offers flexibility and durability. Temperature resistance in both hot and cold environments. Ideal for parking lots, sporting events, festivals and crowd delineation. 18"H. 3 lb. Orange.



ORDER NUMBER	UNIT
SEH138	EA

NEW!

A AURORA TOOLS® INDOOR/ OUTDOOR STANDARD-DUTY EXTENSION CORDS

Designed for light industrial, contractor, and home use. Durable SJTW jacket protects against ultraviolet rays, chemicals and moisture. Molded-on and bonded plugs and connectors resist breaking. 3-Conductor SJTW, 125 V Grounding. 16/3 AWG. 13 A. 1625 W. Orange.



ORDER NUMBER	DESCRIPTION	UNIT
1 XC630	10'	EA
2 XC631	15'	EA
3 XC632	25'	EA
4 XC633	30'	EA

NEW!

B AURORA TOOLS® OUTDOOR VINYL EXTENSION CORDS

Designed for industrial and contractor use. Vinyl jacket protects against rough use, chemicals, and moisture and provides added flexibility. Molded-on and bonded plugs and connectors resist breaking. 3-Conductor SJTW, 300 V Grounding. 14/3 AWG, Orange.



ORDER NUMBER	DESCRIPTION	UNIT
1 XC482	25', 15 A, 1875 W	EA
2 XC483	50', 15 A, 1875 W	EA
3 XC484	100', 13 A, 1625 W	EA



NEW!

C SWAN® COMMERCIAL DUTY RUBBER HOSES

Professional-grade, abrasion resistant cover with high burst strength, resists damage from heat, sub-zero weather and normal wear and tear and stays flexible in extreme weather conditions. Features Seal-Tite leak-proof brass couplings. Lifetime warranty.

ORDER NUMBER	DESCRIPTION	UNIT
1 NJ413	5/8"×50'	EA
2 NJ415	5/8"×100'	EA



D WOODS® POWERCADDY WITH 7.6 m EXTENSION CORD

Unwinds only as much cord as needed – eliminates tangles. With 7.6 m cord, four grounded outlets and built-in 10-amp circuit breaker.

ORDER NUMBER	UNIT
502801	EA



E WOODS LIGHT DUTY OUTDOOR EXTENSION CORDS

Made with specially treated, double insulated jackets. Cord is CUL approved, weatherproof, UV resistant and flexible in -40° weather. 16 gauge. 13 amps. Orange.

ORDER NUMBER	DESCRIPTION	UNIT
1 541548	15 m	EA
2 541522	10 m	EA
3 541550	15 m, power indicator	EA



F STANLEY® TAPE MEASURES

Polymer coated blade withstands abrasion. High impact case for durability. Corrosion-resistant end hook for accurate measurements.

ORDER NUMBER	DESCRIPTION	UNIT
1 30-496	16'/5m	EA
2 30-455	25'	EA
3 34-106	100'	EA

G STANLEY® SHARPSHOOTER® HEAVY DUTY STAPLE GUN

Patented Easy-Squeeze design reduces effort and hand fatigue; anti-jam mechanism. Delivers high power and deep penetration. Durable aircraft-aluminum housing; fast and easy bottom loading design. High-visibility safety yellow colour.



ORDER NO.	DESCRIPTION	UNIT
1 TR150	Staple gun	EA
2 TRA708T	Staples, 1/2"	1000/PK
3 TRA706T	Staples, 3/8"	1000/PK
4 TRA704T	Staples, 1/4"	1000/PK

CLEANING, BREAKROOM AND FACILITIES

Facility Supplies – tools

NEW!



A MILWAUKEE SUB-COMPACT CORDLESS DRILL/DRIVER KIT

Light compact design. Built-in LED light. Battery Fuel gauge. 12 V. 1/4". Hex quick connect. 150 in. lbs maximum torque. 0 to 500 RPM. (2x) 1.4 Ah Lithium-Ion Batteries, Charger and Tool bag.

ORDER NUMBER	UNIT
TLZ166	EA



B STANLEY® HIGH-IMPACT ABS TORPEDO LEVEL

Constructed of ABS plastic for impact resistance. High-visibility orange colour makes it easy to identify on the jobsite. Top-reading feature allows visibility from above. Tinted 360° vials for readability. 8".

ORDER NUMBER	UNIT
42-294	EA

NEW!



C AURORA TOOLS® HEAVY-DUTY HACKSAW FRAME

Strong aluminum die-cast handle provides comfort and control and guarded grip design protects knuckles from grazing. Plain handle. Depth of Bow: 4" H. Tensile Strength: 8000 PSI. 17^{5/16}" L x 5^{1/8}" H.

ORDER NUMBER	UNIT
TYW991	EA



D AURORA TOOLS® ACTION BAR

High quality, heat-treated carbon steel. Edges are specially bevelled for pulling, lifting and scraping. 13^{1/2}" L x 1^{3/8}" H. Black.

ORDER NUMBER	UNIT
TJZ047	EA

E WD-40® MULTI-USE LUBRICANT

Protects metal from rust and corrosion, penetrates stuck parts, displaces moisture and lubricates just about anything.



ORDER NUMBER	DESCRIPTION	UNIT
1 61536-01005	155 g	EA
2 61536-01011	311 g	EA

NEW!

F WD-40 SPECIALIST® WHITE LITHIUM GREASE

Ideal for metal-to-metal applications that require heavy-duty lubrication. Leaves behind a rust-inhibiting barrier for protection against corrosion. This long-lasting formula won't melt, freeze, or run in harsh weather conditions.



ORDER NUMBER	UNIT
61536-01080	EA

CLEANING, BREAKROOM AND FACILITIES

F AURORA TOOLS® COMBINATION WRENCH SET

Chrome vanadium steel for strength and durability and precision broached jaws for sure gripping. Thin walled construction for access in cramped quarters and heat treated for consistent hardness. 12-point box end for snug fit. Meets ANSI standards. 11 pieces/set.



ORDER NUMBER	UNIT
--------------	------

METRIC

Includes: 7 mm, 8 mm, 9 mm, 10 mm, 11 mm, 12 mm, 13 mm, 14 mm, 15 mm, 17 mm, and 19 mm

1 TLV054

ST

IMPERIAL

Includes: 1/4", 5/16", 3/8", 7/16", 1/2", 9/16", 5/8", 11/16", 3/4", 7/8", 15/16"

2 TLV053

ST



490

Freight charges may apply. Check online for the most current price.



A AURORA TOOLS® MINI LED FLASHLIGHT

Nine ultra bright LED lights. Lightweight design. Features a wrist strap. 25 lumens. 3 "AAA" batteries included. 3 3/8" x 1". Black.

ORDER NUMBER	UNIT
XD079	EA



B AURORA TOOLS® LED FLASHLIGHT

Twenty-eight LED lights. Aluminum casing. Shatterproof lens. Run time of 2 hours on high and 3 hours on low. 98 lumens. 3 "AAA" batteries included. 5" x 1 1/2". Black.

ORDER NUMBER	UNIT
XE888	EA



C ENERGIZER® RECHARGEABLE LED LIGHT

Light turns on when the power goes out. Bright-white LED. 3 hour runtime. 40 lumens.

ORDER NUMBER	UNIT
RCL1FN2WR	EA



D AURORA TOOLS® CREE® LED PENLIGHT

High-quality penlight is very bright, extremely durable all while being lightweight to alleviate wrist fatigue. Ideal for various applications such as household work, automobile maintenance and recreational activities. Features aluminum body, push on/off button, and convenient clip. 80 Lumens. 2 "AAA" batteries included.

ORDER NUMBER	UNIT
XH073	EA



E SCOTCH™ EXTREME FASTENERS

Excellent for holding a fire extinguisher, securing lights and accessories on a bicycle or hanging outdoor décor on siding and fences. Locks 3X stronger than Velcro®. 1" x 4". Clear.

ORDER NUMBER	UNIT
RF6740	PK



NEW!

F AURORA TOOLS® PORTABLE TOOL BOX WITH METAL TOOL TRAY

Durable steel construction with heavy-plated latches. High gloss powder coat paint finish. Holds up to 50 lbs. 21"W x 8 3/4"D x 9"H. 12 lbs. Red.

ORDER NUMBER	UNIT
TEP336	EA



G STANLEY® SERIES 2000 TOOL BOX

With two lid organizers for small parts, accessible without opening the tool box. Soft, wide rubber coated handle for a comfortable grip; nickel-plated latches, inside tote tray for small items.

ORDER NUMBER	UNIT
019151M	EA



H STANLEY® SORTMASTER™ JUNIOR ORGANIZER

Secured stacking option of several organizers saves space and maintains organization. Features removable dividers to provide customization for small parts and larger tools. 14 1/16"W x 11 1/2"D x 2 7/16"H.

ORDER NUMBER	UNIT
STST14022	EA



Facility Supplies – tools



A AURORA TOOLS® AP100 SERIES PAINT BRUSH SET

Tin-plated ferrule. Well-suited for latex-based paints. 100% black polyester bristles with plastic handle. Includes 4 flat brushes 1", 2", 3", & 4" wide. 4/set.

ORDER NUMBER	UNIT
KP853	ST



B STANLEY® 6-WAY SCREWDRIVER

Convenient and space-saving design reduces the number of tools users must carry. Chrome-plated bar resists corrosion. Standard and Phillips® tips and two nut drivers.

ORDER NUMBER	UNIT
68-012	EA



C STANLEY® 2-PACK FOLDING METRIC & SAE HEX KEYS

Rubber side insert allows for a secure grip and the chamfered edge helps guide the wrench for a smooth, easy entry of the hex key. It has size markings printed on the body for easy identification. Durable composite construction.

ORDER NUMBER	UNIT
STHT71839	2/PK

D STANLEY® THREE-PIECE FORGED STEEL PLIER SET

Forged steel construction; chrome-nickel steel hand ground cutting edges; rust-resistant finish. Double dipped handles for comfortable use; machined jaws for gripping. Set includes slip joint, long nose and diagonal cutting pliers.



ORDER NUMBER	UNIT
84-114	EA

E STANLEY® MULTI-BIT RATCHETING SCREWDRIVER SET

Three-position switch enables clockwise and counterclockwise ratcheting and locked position. Durable bi-material handles for comfortable grip. Magnetic bit holder for secure storage of bits. Internal bit storage for easy access and fast changeover of bits. Yellow. 10 pieces.

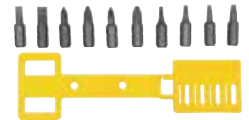

ORDER NUMBER	UNIT
68-010	EA



F IRWIN® VISE-GRIP® PLIERS

Curved jaw with wire cutter.

ORDER NUMBER	DESCRIPTION	UNIT
1 TM917	7"	EA
2 TM873	10"	EA



G AURORA TOOLS® ADJUSTABLE WRENCH

Superior grade chrome vanadium steel and precision machined jaws. Slim profile head slips into cramped quarters and tight tolerances ensure close fitting, wobble-free action. Standard Jaw. Smooth, non-sticking mechanism. Black nickel finish resists rust. 6". Meets ANSI standards.

ORDER NUMBER	UNIT
TJZ100	EA



H STANLEY® 16-OZ. FIBERGLASS HAMMER

Heat treated and rim tempered 16-oz. steel head with curved claw is durable and safe; high-visibility yellow fiberglass handle absorbs shocks and vibrations – more durable than wood.

ORDER NUMBER	UNIT
STHT51512	EA



I AURORA TOOLS® RUBBER MALLET

Non-marking white rubber head with hardwood handle. 16 oz.

ORDER NUMBER	UNIT
TJZ045	EA



A RICHARD PUTTY KNIFE

Flexible steel putty knife with a polypropylene handle. 3"×3" blade.

ORDER NUMBER	UNIT
TK902	EA



B OLFA® MULTIPURPOSE SCRAPER

High quality disposable stainless steel blade. Includes blade cover for safety and a hang-hole in the handle for convenience. 2½".

ORDER NUMBER	UNIT
1086562	EA



C OLFA® SK-4 HEAVY DUTY SELF-RETRACTING SAFETY KNIFE

Features a spring-retractable blade and a stainless steel blade channel.

ORDER NUMBER	DESCRIPTION	UNIT
1 9048	SK-4, 18 mm knife	EA
2 9613	SKB-2/5 trapezoid blades	10/PK

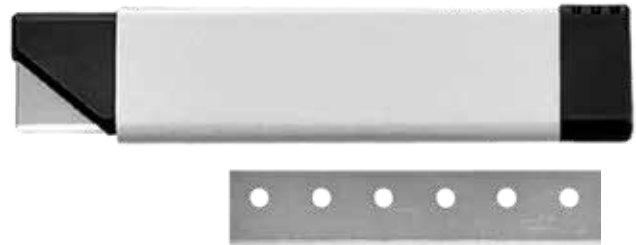

D OLFA® CTN-1 CARTON CUTTER

Pocket-sized cutter uses a 6-segmented snap-off blade; slide closure.

ORDER NUMBER	DESCRIPTION	UNIT
1 9985	CTN-1 cutter	EA
2 9986	CTB-5 blades	5/PK



E STANLEY® CLASSIC 99® RETRACTABLE UTILITY KNIFE

Interlocking nose to hold blade securely. Three-position retractable blade. Storage in handle. Cut and trim with ease. Precision-honed edge for consistent and long cutting life.

ORDER NUMBER	DESCRIPTION	UNIT
1 10-099	99®	EA
2 11-921	1992® heavy duty blades	5/PK



F OLFA® 180 MULTI-PURPOSE METAL HANDLE UTILITY KNIFE

The modern version of the original snap-off cutter developed by Olfa® in 1956. Perfect for general home or office use. Features a slide lock, pocket clip and built-in blade snapper. Uses 5010 and 5015 blades.

ORDER NUMBER	DESCRIPTION	UNIT
5001	180, 9 mm knife	EA



G WESTCOTT® KLEENCUT® TOUCH KNIFE

Sturdy metal and plastic construction. Stainless steel retractable blade.

ORDER NUMBER	UNIT
65956-04304	CD



H WESTCOTT® CERAMIC SAFETY BLADE MINI BOX CUTTER

Ceramic blades are safer and stay sharper up to 10 times longer than conventional steel blades. Strong and lightweight in a convenient compact design. Study fixed blade and finger loop for added control.

ORDER NUMBER	UNIT
73577-16473	EA

Facility Supplies – knives



A OLFA® FIBERGLASS UTILITY KNIFE

Fiberglass-reinforced handle with ergonomic wraparound anti-slip rubber grip. Multi-purpose metal pick and stainless steel blade channel. Pre-loaded with an 18mm LBB heavy-duty ultra-sharp black snap-off blade.

ORDER NUMBER	DESCRIPTION	UNIT
1 1072198	LA-X knife, 18 mm	EA
2 9070	LBB-10B blades	10/PK

NEW!



C OLFA® XA-1 FIBERGLASS REINFORCED AUTO-LOCK UTILITY KNIFE

The wraparound, anti-slip grip and curved finger stop are designed to give you better control. Plus, the handle is chemically resistant to paint and MRO environments. Use to cut packaging, shrink wrap, vinyl, window film, wallpaper, caulking or foam board and more. Pre-loaded with an ABB (9148) black ultra-sharp snap-off blade.

ORDER NUMBER	DESCRIPTION	UNIT
1075449	XA-1 knife, 9 mm	EA



B OLFA® STAINLESS STEEL AUTO-LOCK PRECISION KNIFE

Corrosion and chemical resistant body. Ultra-slim for maneuverability and auto-lock blade actuator. Pocket clip and blade snapper. Pre-loaded with a 9mm ABS Precision stainless steel snap-off blade.

ORDER NUMBER	DESCRIPTION	UNIT
5019	SVR-2 knife, 9 mm	EA



D OLFA® L-1 HEAVY DUTY SNAP OFF UTILITY CUTTER

Popular heavy-duty cutter features a contoured ABS handle and ratchet wheel blade lock. Professional strength stainless steel blade channel secures blade for the toughest of cutting jobs. Easy, tool-free blade change. Pre-loaded with an LB snap-off blade.

ORDER NUMBER	DESCRIPTION	UNIT
5003	L-1 cutter, 18 mm	EA



E OLFA® RUBBER INSET GRIP RATCHET-LOCK L-2 UTILITY KNIFE

This heavy duty knife features a pistol-shaped handle design with an anti-slip ribbed rubber inset and finger stop. Pre-loaded with an LB snap-off blade.

ORDER NUMBER	DESCRIPTION	UNIT
5004	L-2 knife, 18 mm	EA



F OLFA® CL HEAVY DUTY CUTTER

Versatile, heavy-duty utility knife with unique cutting guide that delivers accurate trimming for drop ceiling tiles; sturdy cutting base allows for a perfect 90° cutting edge. Cutting guide and built-in staple remover for efficient and accurate corrugate box cutting. Features a high-impact ABS handle and ratchet-wheel blade lock. Pre-loaded with an LB snap-off blade.

ORDER NUMBER	DESCRIPTION	UNIT
9021	CL knife, 18 mm	EA



G OLFA® SK-10 PRO CONCEALED SAFETY KNIFE

Four-point positionable blade is ideal for cutting shrink wrap, plastic strapping and more.

ORDER NUMBER	DESCRIPTION	UNIT
1 1096854	SK-10 Pro knife, 18 mm	EA
2 1096855	Replacement blades	10/PK



H OLFA® SNAP-OFF BLADES

ORDER NUMBER	DESCRIPTION	UNIT
--------------	-------------	------

LB FOR DL-1, L-1, L-2, LA-X AND CL KNIVES

1 5009	18 mm, 10-pack, LB-10B	PK
2 5016-OLF	18 mm, 50-pack, LB-50B	PK

AB FOR 180, DA-1, SVR-2 AND XA-1 KNIVES

3 5010	9 mm, 10-pack, AB-10B	PK
4 5015	9 mm, 50-pack, AB-50B	PK
5 9148	9 mm, 10-pack, AAB-10B Ultra sharp	PK

Facility Supplies – adhesive tapes



A SCOTCH® CONTRACTOR GRADE MASKING TAPE

General purpose tape designed for office use and mounting drafting material. Fits all dispensers that accept 3" tape core. High adhesion.

ORDER NUMBER	DESCRIPTION	UNIT
1	2020-18AP 18 mm×55m	RL
2	2020-24AP 24 mm×55m	RL
3	2020-24EP6 24 mm×55m	6/PK
4	2020-36AP 36 mm×55m	RL
5	2020-36EP4 36 mm×55m	4/PK
6	2020-48MP 48 mm×55m	RL



B 3M™ 764 VINYL TAPE

Used to clearly mark areas. Ideal for factories, warehouses and hospitals. Sticks on contact to a wide variety of surfaces including curved, rough and uneven surfaces. Removes cleanly, leaving no sticky residue. 2"×108' (48 mm×33 m).

ORDER NUMBER	DESCRIPTION	UNIT
1	764-2x36-BLU Blue	RL
2	764-2x36-RED Red	RL
3	764-2x36-YLW Yellow	RL



C SCOTCH® BLUE™ ORIGINAL PAINTER'S TAPE

Medium adhesion tape ideal for smooth and lightly textured surfaces such as cured painted surfaces, wood floors, metal, and glass. Removes cleanly without adhesive transfer or surface damage for up to 14 days.

ORDER NUMBER	DESCRIPTION	UNIT
1	2090-24E-G 24 mm×18.2m	RL
2	2090-36EC 36 mm×18.2m	RL



D SCOTCH® GENERAL PAINTING PAINTER'S TAPE

Medium adhesion tape ideal for painted surfaces, wood floors, metal, and glass. Removes cleanly without adhesive transfer or surface damage for up to 8 days.

ORDER NUMBER	DESCRIPTION	UNIT
1	2055-24NP 24 mm×18.2m	RL
2	2055-36NP 36 mm×18.2m	RL



E TARTAN™ FILAMENT TAPE

Light-duty high strength tape for utility bundling, reinforcing and pallet unitizing applications. Synthetic rubber adhesive bonds easily to most fiberboard, plastics and metal surfaces. Tape resists nicks, abrasions, moisture and scuffing.

ORDER NUMBER	DESCRIPTION	UNIT
1	8934-18X55 18 mm×55 m	RL
2	8934-24X55 24 mm×55 m	RL



F 3M™ DUCT TAPE

All-around holding, splicing, masking, patching, sealing and seaming tape. Polyethylene coated cloth backing with rubber adhesive offers high tack, conformability, strength and easy tear. 48 mm×55m. Silver.

ORDER NUMBER	UNIT
3939-2X60	RL



G 3M™ BASIC DUCT TAPE

Cloth duct tape with good holding power. 48 mm×50.2m. Silver.

ORDER NUMBER	UNIT
1055	RL



H GORILLA® CRYSTAL CLEAR TAPE

No other tape offers the clarity, strength and durability of this tape. Best for providing a weatherproof, airtight bond. Repair, fix, patch, seal, hold and protect almost any surface. Crystal Clear. Won't yellow outdoors. Water, UV and temperature resistant. Tear by hand.

ORDER NUMBER	DESCRIPTION	UNIT
AF419	38 mm (1½") ×4.5 m (15')	RL



CLEANING, BREAKROOM
AND FACILITIES

Freight charges may apply. Check online for the most current price.



A SCOTCH™ CAUTION BARRICADE TAPE

Bold two-inch black characters on bright background designed to attract attention and provide a warning that is clearly visible. Constructed of polyethylene plastic that prevents accidental tearing. 3" (76 mm×91.4 m). Yellow.

ORDER NUMBER	UNIT
301	RL

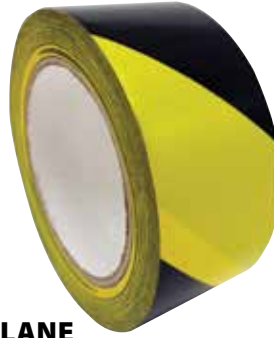

B TORY LANE MARKING TAPE

Heavy duty PVC tape with acrylic adhesive. Easy to mark off hazardous areas. 3"×108' (76 mm×33m). Yellow and Black.

ORDER NUMBER	UNIT
TAPE0253	RL



C SCOTCH® CARPET TAPE

Designed for smooth surfaces. For use on vinyl, ceramic and hardwood floors. Indoor use only. Permanent.

ORDER NUMBER	DESCRIPTION	UNIT
CT2010	1½"×42'	RL



D 3M™ MULTI-USE COLOURED DUCT TAPE

Boldly-hued solution to match project's colour scheme. Strong adhesive and water-resistant backing is perfect for repairs, organization, labelling, crafts, and automotive fixes. 1½" (48 mm×18.2 m).

ORDER NUMBER	DESCRIPTION	UNIT
1 3920-RD-6C	Red	RL
2 3920-YL-6C	Yellow	RL
3 3920-BK-6C	Black	RL



E 3M™ HAZARD MARKING DUCT TAPE

High adhesion poly scrim-backed tape used for marking safety lanes on floors, overhead hazards, and other hard-to-notice obstructions. Diagonal stripe format for high visibility. 1½" (48 mm×22.8 m).

ORDER NUMBER	DESCRIPTION	UNIT
1125-RW	Red and White	RL



F LEPAGE® EXTREME GLUE

Extreme resistance to shock and all weather conditions with a non-drip formula. 50 g.

ORDER NUMBER	UNIT
2764487	EA

CLEANING, BREAKROOM AND FACILITIES



G STANLEY® HEAVY DUTY HOT MELT GLUE GUN

Trigger-feed glue gun uses hot melt glue sticks. Heats up quickly and bonds within 60 seconds.

ORDER NUMBER	DESCRIPTION	UNIT
1 GR20	Glue gun	EA
2 GS20DT	Dual temperature glue stick refills, 4"	24/PK



H ELMER'S® CARPENTER'S® WOOD GLUE

Made just for furniture repair and general household projects. Sandable & paintable. Sets fast. Easy water cleanup. Non-toxic. 236 mL.

ORDER NUMBER	UNIT
60613TR	EA



I LEPAGE® NO MORE NAILS® ALL PURPOSE CONSTRUCTION ADHESIVE

Instant grab adhesive. Bonds a variety of materials such as wood, metal, studs, drywall, masonry, ceramics, carpet and foam board. Holds projects in place without nails or bracing.

ORDER NUMBER	DESCRIPTION	UNIT
2047863	88 ml	EA

Facility Supplies – key control



A SENTRY® SAFE KEYBOXES

Privacy key lock. Includes key tags and labels, in four colours. Bolt-down hardware included. Durable enamel finish. Black.

ORDER NUMBER	DESCRIPTION	UNIT
1 KB-25	25 key hangers, 9 ²⁷ / ₃₂ " H×7 ¹³ / ₃₂ " W×3 ³ / ₈ " D	EA
2 KB-50	50 key hangers, 11 ¹³ / ₁₆ " H×9 ⁷ / ₁₆ " W×3 ³ / ₈ " D	EA



B ROYAL SOVEREIGN® ELECTRONIC KEY SAFE

The programmable, battery operated key pad provides the highest level of control and security; no keys to lose. Heavy-duty steel construction with side key depository slot. Two manual override keys and batteries included. Mounting hardware and key tags included.

ORDER NUMBER	DESCRIPTION	UNIT
KMCG-48EL	48 key, 11 ¹ / ₂ " W×3 ¹⁵ / ₁₆ " D×14 ¹³ / ₃₂ " H	EA



C MERANGUE® DELUXE KEY RACK

A great way to organize and identify keys for home, office and garage. Holds 8 keys.

ORDER NUMBER	DESCRIPTION	UNIT
1008-4251-00-000	Key rack	EA



D MERANGUE® KEY TAGS

Metal split rings, customizable inserts. Assorted colours.

ORDER NUMBER	UNIT
1008-7601-00-000	20/PK



E WESTCOTT® KEY RINGS

Chrome split key rings hold multiple keys securely.

ORDER NUMBER	DESCRIPTION	UNIT
65956-72108	1 ¹ / ₄ " diameter	10/PK

F MASTER LOCK® PLASTIC KEY TAGS

Fits most key cabinets and key racks. White. 20/pkg.

ORDER NUMBER	DESCRIPTION	UNIT
7116D	Round, 1 ¹ / ₄ "	PK



G MERANGUE® TAGS

Round, white with metal rim.

ORDER NUMBER	DESCRIPTION	UNIT
1024-3011-00-000	1 ¹ / ₄ " diameter	50/PK



H MASTER LOCK® SELECT ACCESS™ KEY SAFES

Protective weather cover prevents freezing. Large internal cavity and removable key hook. Push button. Alpha & numeric. 4,096 possible combinations. Durable metal construction. Holds up to 5 keys. 4.6875"H×3.75"W×2"D. Grey.

ORDER NUMBER	DESCRIPTION	UNIT
1 5422D	Door knob mount, 1.81 lbs Molded bumper, vinyl coated shackle prevent scratching. 1.833"H×1.40625"W shackle clearance	EA
2 5423D	Wall mount, 1.64 lbs	EA



Facility Supplies – locks

A DUDLEY® COMBINATION LOCKS

Three-digit combination; hardened steel shackle provides extra cut resistance. School standard lock since 1922.



ORDER NUMBER	DESCRIPTION	UNIT
1 DYRP7SP	Standard combination lock	EA
2 DYRP3SP	Serialized for extra security	EA

B WESTCOTT® COMBINATION PADLOCK

Etched number markings provide clarity. For use with 3-number combination provided with lock. Chrome steel case. 1 1/8" diameter. Black.



ORDER NUMBER	UNIT
65956-05604	EA

C MASTER LOCK® COMBINATION LOCKS

3 digit dialing and 1,500 combinations for maximum security. Hardened steel shackle for extra cut resistance. 1 7/8" (48mm).



ORDER NUMBER	DESCRIPTION	UNIT
1 1500D	Black/Silver	EA
2 1530DCM	Assorted Metallic	EA

D WESTCOTT® ANTIMICROBIAL COMBINATION PADLOCK

Etched number markings provide clarity. For use with 3-number combination provided with lock. Chrome steel case. 1 1/8" diameter. Assorted colours.



ORDER NUMBER	UNIT
65956-05606	EA

NEW!

F MASTER LOCK® LAMINATED PADLOCK

Outdoor protection against moisture, dirt and grime. Features weather-resistant thermoplastic shell, 40mm wide laminated steel body. Hardened steel shackle, dual ball bearing locking, 4-pin cylinder. 1-9/16" (40mm). Blue.



ORDER NUMBER	UNIT
312D	EA

E MASTER LOCK® MAGNUM™ LAMINATED LOCK

Reinforced body bumper for scratch resistance. Rust-Oleum® certified protection guarantees lock body will not rust. Stainless steel top/bottom caps and rivets. Zinc body. 2.5" (63.5 mm) shackle clearance. Silver.



ORDER NUMBER	UNIT
M1BCLDLJHC	EA

G MASTER LOCK® MAGNUM™ COVERED LAMINATED LOCKS

4-pin cylinder. Rust-Oleum® certified protection. Tough-Cut™ octagonal boron-carbide shackle is harder than hardened steel. 1.5" (38 mm) shackle clearance. Black.



ORDER NUMBER	UNIT
1 M115BCLDLFHC	EA
2 M115BCLTRILFHC	3/PK

H MASTER LOCK® BRASS PADLOCKS

4-pin cylinder helps prevent picking. Dual locking levers resist prying and hammering. Stylish, strong brass body resists corrosion. Hardened steel shackle for superior cut resistance. Includes 2 keys. Brass.



ORDER NUMBER	DESCRIPTION	UNIT
1 140D	3/8" (22.3 mm)	EA
2 140DLH	2" (50.8 mm) shackle	EA
3 140QLH	2" (50.8 mm) shackle	4/PK

I MASTER LOCK® TSA APPROVED LUGGAGE LOCKS

TSA screeners can inspect and relock baggage, without damaging the lock. Convenient, keyed alike sets ideal for family travel. Durable, solid metal body. Steel shackle offers resistance to cutting and sawing. 3/8"W (22mm) body.



ORDER NUMBER	UNIT
4683Q	4/PK

NEW!



A FEATHERLITE 6500 SERIES EXTRA-HEAVY DUTY PLATFORM STEPS

Extra heavy duty non-conductive “C” channel side rails in high visibility safety yellow. Large standing platform. Wide 3” slip-resistant serrated aluminum steps and a 14” x 18” standing platform. Fiberglass. 300 lb capacity.

ORDER NUMBER	DESCRIPTION	UNIT
1 6504	4' tall, 15 lbs	EA
2 6506	6' tall, 25 lbs	EA



B RUBBERMAID® TWO-STEP FOLDING STEPSTOOL

Stool with skid-resistant feet stands upright when folded. Slim width takes up minimal space. Holds up to 300 lbs. 18 1/2”W×5 1/2”D×25”H.

ORDER NUMBER	DESCRIPTION	UNIT
FG420903CYLND	Grey	EA



D GLOBE MOBILE STEP STOOL

Textured steps for better grip. Sturdy spring loaded casters. Holds up to 300 lbs.

ORDER NUMBER	DESCRIPTION	UNIT
5250	16" diameter×14"H	EA



C FEATHERLITE 3400 SERIES EXTRA-HEAVY DUTY STEP LADDER

Tough copolymer top for strength and durability. 3” slip-resistant serrated aluminum steps and zinc-coated steel spreader arms. Heavy duty hinged utility tray for holding tools and paint accessories. Aluminum. 300 lb capacity.

ORDER NUMBER	DESCRIPTION	UNIT
1 3406	6' tall, 17 lbs	EA
2 3404	4' tall, 11 lbs NEW!	EA



E 3M™ SAFETY-WALK™ TREAD

For sure-footed protection on indoor and outdoor metal, wood and concrete. Used on stairways, steps, ladders, boat decks and more to help reduce slips and falls. Strong adhesive resists cracking and peeling yet feels comfortable under bare feet. Mold and mildew resistant.

ORDER NUMBER	DESCRIPTION	UNIT
1 610B-R1X180	1"W×180"L, Black	RL
2 370G-R2X180	2"W×180"L, Grey	RL

Facility Supplies – pallet trucks and ladders



A KLETON® HEAVY DUTY HYDRAULIC PALLET TRUCKS

Forks feature entry rollers and tapered design for easy pallet entry and are reinforced for heavy duty loads. Pallet truck height lowered is 27/8" and raised is 73/4" high. Featuring 3-function hand control (raise, neutral and lower) and spring-loaded self-righting safety loop handle. 5,500 lb capacity. Orange.

ORDER NUMBER	DESCRIPTION	UNIT
1 MJ484	20½"×36"	EA
2 MJ485	20½"×42"	EA
3 MJ486	20½"×48"	EA
4 MJ487	27"×36"	EA
5 MJ488	27"×42"	EA
6 MJ489	27"×48"	EA
7 ML372	All nylon steering wheels & rollers, 27"×48"	EA



D KLETON® HYDRAULIC PALLET TRUCKS

Heavy duty plastic roller facilitates entry and exit of pallets. 5,500 lb capacity. 1-year limited warranty. Yellow.

ORDER NUMBER	DESCRIPTION	UNIT
CAST IRON CORE STEERING WHEELS AND ROLLERS		
1 ML966	3¼" to 7¼"H×36"L, 20½" frame width	EA
2 ML967	3¼" to 7¼"H×42"L, 20½" frame width	EA
3 ML968	3¼" to 7¼"H×48"L, 20½" frame width	EA
4 ML969	3¼" to 7¼"H×36"L, 27" frame width	EA
5 ML970	3¼" to 7¼"H×42"L, 27" frame width	EA
NYLON CORE STEERING WHEELS AND ROLLERS		
6 ML972	3¼" to 7¼"H×48"L, 27" frame width	EA



B KLETON® RUBBER CHOCKS

Fabricated from a resilient rubber compound, reinforced for maximum wearability and strength. 8"W×9"D×6"H. 10 lbs.

ORDER NUMBER	DESCRIPTION	UNIT
1 KH600	With handle	EA
2 KH601	With eyebolt	EA

C KLETON® WHEEL CHOCK WALL BRACKET

Prevents loss of chock. Fits wheel chocks up to 10" wide. Metal construction. Yellow.



ORDER NUMBER	UNIT
KH963	EA



E KLETON® ROLLING STEP LADDERS

Ideal wherever there is a need to reach bulky materials. Rolls easily into position and locks firmly to the floor for maximum safety. Non-clogging slip-resistant steel steps. Frame is rugged welded 1" round steel tubing. CSA certified to the ANSI A14.7 standard. 300 lb capacity. Kleton® Blue enamel finish.

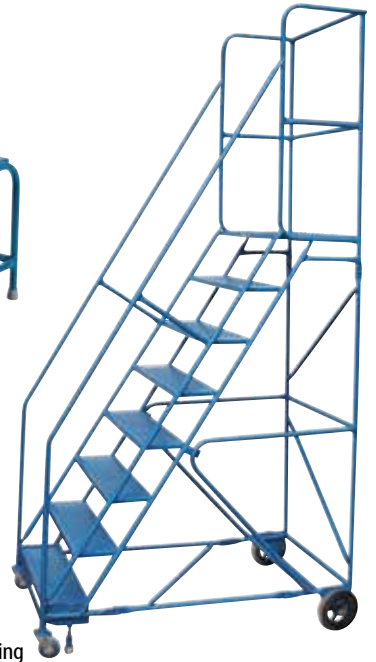

ORDER NUMBER	# OF STEPS	HANDRAILS YES/NO	TOP STEP HEIGHT	BASE DIMENSIONS	WEIGHT
22"×8" STEP SIZE, 22"×16" TOP STEP					
1 MA612	2	No	19"	24"W×26"D	32 lbs
2 MA613	3	No	28"	24"W×30"D	42 lbs
3 MH279	4	No	37"	24"W×37"D	52 lbs
4 MA615	5	No	46"	24"W×41"D	61 lbs
5 MA614	4	Yes	37"	30"W×36"D×78"H	78 lbs
6 MA616	5	Yes	46"	30"W×46"D×87"H	89 lbs
7 MA617	6	No	55"	30"W×51"D×95"H	100 lbs
30"×8" STEP SIZE, 30"×16" TOP STEP					
8 MA622	8	Yes	72"	38"W×60"D×113"H	180 lbs
9 MA623	10	Yes	89"	38"W×72"D×130"H	230 lbs
10 MA624	12	Yes	109"	38"W×80"D×149"H	250 lbs
11 MA625	14	Yes	128"	38"W×93"D×167"H	275 lbs
12 MA626	16	Yes	144"	38"W×104"D×185"H	305 lbs

NOTE: Ladders are not to be used as work platforms

Freight charges may apply. Check online for the most current price.

Facility Supplies – hand and platform trucks

A SAFCO® CONVERTIBLE HAND TRUCK

Tuff truck™ convertible hand truck can be used as a two-wheeled truck and a four-wheeled platform truck. Capacity: 400 lbs. (2 wheels), 500 lbs. (4 wheels). Greenguard certified.



ORDER NUMBER	DESCRIPTION	UNIT
4070	18½"W×12"D×52"H	EA

B SAFCO® TUFF TRUCK™ CONTINUOUS HANDLE HAND TRUCKS

This hand truck hauls up to 400 lbs., has 8" solid rubber wheels and is made of heavy gauge tubular steel with welded joints for extra strength. Greenguard certified.



ORDER NUMBER	DESCRIPTION	UNIT
4069	19½"W×14½"D×45½"H	EA

C SAFCO® TUFF TRUCK™ ECONOMY PLATFORM TRUCK

Solid, all-welded steel frame, 400 lb. capacity. Large platform with anti-skid mat; two stationary and two swivel 4" casters; folding handle; ¾" wrap-around vinyl bumper. Greenguard certified.



ORDER NUMBER	DESCRIPTION	UNIT
4072	29"×19" platform	EA



D SAFCO® STOW AND GO™ CART

Collapsible design for compact storage; ships assembled. Lightweight aluminum frame, telescoping handle, 5" solid rubber retracting wheels, fold-up toe plate and 110 lb. carrying capacity. Collapses to 15¼"W×2½"D×25" H. Greenguard certified.



ORDER NUMBER	DESCRIPTION	UNIT
4049NC	15¾"W×16¼"D×39½"H (extended)	EA



E SAFCO® HIDE-AWAY™ HAND TRUCK

Collapsible handle and fold-up 14"×9" steel toe plate for compact storage. Lightweight aluminum frame has 6" diameter rubber tires on its steel hub. 250 lb. capacity. Collapses to 15½"W×8"D×29"H. Greenguard certified.



ORDER NUMBER	DESCRIPTION	UNIT
4061	15½"W×16½"D×43½"H (extended)	EA



F MAGLINER ALUMINUM HAND TRUCKS

Strength, durability and versatility in a lightweight truck. Totally modular and have no welds to break. 500 lb. capacity.

ORDER NUMBER	DESCRIPTION	UNIT
--------------	-------------	------

CONTINUOUS HANDLE

1 MA275 16"W×48"H with 14"W x 7½"D nose plate EA

P HANDLE

2 MA268 21"W×52"H with 18"W×7½"D nose plate EA



G KLETON® PLATFORM TRUCKS

All-welded design. Removable 1¼" chrome handle can be inserted at either end. Two swivel and two rigid bolted-on casters. Blue.

ORDER NUMBER	DESCRIPTION	UNIT
--------------	-------------	------

900 LB CAPACITY, 6" CASTERS

1 MB235 24"W×36"D EA
2 MB243 24"W×48"D EA

1200 LB CAPACITY, 5" CASTERS

3 MB237 24"W×36"D EA
4 MB245 24"W×48"D EA

1400 LB CAPACITY, 8" CASTERS

5 MB236 24"W×36"D EA
6 MB244 24"W×48"D EA

Facility Supplies – shelving

A GLOBAL™ METAL SHELVING

Provides a heavy duty storage solution. Six durable shelves are secured together with self-locking nuts to achieve optimum strength and safety. They are made from 20 gauge steel which allows each shelf to hold up to 300 lbs. evenly distributed. Rounded edges and corners prevent possible cuts and clothing snags while floor glides protect the existing floor surface. Charcoal.



ORDER NUMBER	DESCRIPTION	UNIT
1 BSS61272	36"W×12"D×72"H	EA
2 BSS61872	36"W×18"D×72"H	EA
3 BSS62472	36"W×24"D×72"H	EA

C METALSISTEM SUPER 123 STANDALONE HEAVY DUTY SHELVING SYSTEM

Metalsistem's boltless system allows its user to simply and easily assemble the shelving unit without any special tools or know-how. Made from prime quality tensile steel this unit is built to last, and holds up to 330lbs per shelf and 2500 for the entire shelving unit. Boltless shelving, no tools, no hassles, simple and quick assembly. Wide range of accessories. High tech Italian design with attractive bright finish. Light and strong galvanized steel, corrosion resistant quality. Great for home and office use alike.



ORDER NUMBER	DESCRIPTION	UNIT
1 S-1015	1 unit, 78" H×36" W×13" D, 4 levels	EA
2 S-1016	1 unit, 78" H×36" W×13" D, 4 levels plus add on unit	EA
3 S-1001	1 unit, 78" H×36" W×16" D, 5 levels	EA
4 S-1018	1 unit, 78" H×36" W×16" D, 5 levels, plus add on unit	EA
5 S-1002	1 unit, 78" H×48" W×16" D, 4 levels	EA
6 S-1019	1 unit, 78" H×48" W×24" D, 4 levels	EA



E ICONEX™ PARTS BIN

Corrugated fiberboard bin.

ORDER NUMBER	DESCRIPTION	UNIT
9435-0954	4"W×12"D×4"H	EA



B SAFCO® STEEL ARCHIVAL SHELVING

Extra strength storage shelving featuring a heavy-gauge steel frame that locks together without tools. Holds up to 80, 12"W×15"D×10"H letter/legal archival storage boxes. Rated up to 900 lbs. per shelf. Steel pack and warp-free particle board shelves (model 5261) sold separately.

ORDER NUMBER	DESCRIPTION	UNIT
1 5260	Steel frame shelving	EA
2 5261	Particleboard shelves	4/ST

D ADD-ON UNITS FOR SUPER 123 SHELVING

Add-on unit has 4 metal shelf levels, 8 safety clips, 2 plastic tops and 2 plastic bases included.



ORDER NUMBER	DESCRIPTION	UNIT
1 AD783613	Add-on unit, 78" H×36" W×13" D	EA
2 AD783616	Add-on unit, 78" H×36" W×16" D	EA
3 AD784816	Add-on unit, 78" H×48" W×16" D	EA
4 AD784824	Add-on unit, 78" H×48" W×24" D	EA

F CARDINAL® CORRUGATED PARTS BINS

Constructed of durable corrugated fibreboard. Ideal for storing loose parts. Designed to hang from shelf for hands-free access. 100/ctn.

ORDER NUMBER	DESCRIPTION	UNIT
1 B02	2"W×12"D×4½"H	CT
2 B03	3"W×12"D×4½"H	CT
3 B04	4"W×12"D×4½"H	CT
4 B06	6"W×12"D×4½"H	CT
5 B08	8"W×12"D×4½"H	CT
6 B10	10"W×12"D×4½"H	CT
7 B12	12"W×12"D×4½"H	CT
8 B1802	2"W×18"D×4½"H	CT
9 B1804	4"W×18"D×4½"H	CT
10 B1806	6"W×18"D×4½"H	CT
11 B1808	8"W×18"D×4½"H	CT
12 B1812	12"W×18"D×4½"H	CT
CARDINAL® CORRUGATED DIVIDERS		
13 BD02	1¾"W×3¾"D×4¾"H	CT
14 BD03	2¾"W×3¾"D×4¾"H	CT
15 BD04	3¾"W×3¾"D×4¾"H	CT
16 BD06	5¾"W×3¾"D×4¾"H	CT

✓ ASSEMBLE EASILY:
 - END-TO-END
 - RIGHT ANGLES, or
 - ANY COMBINATION



A KLETON® HEAVY DUTY CHROMATE WIRE SHELVING

Heavy-gauge chromate plated shelves with open wire design minimize dust, improve air circulation and provide greater visibility of stored items. Post's circular grooves combined with tapered plastic split sleeves allow for assembly in minutes with no special tools. Shelf ribs run front to back allowing items to slide on and off shelves smoothly. Shelves can be adjusted at precise 1" intervals and shelf posts are double grooved every 8" and numbered for easy adjustment.

ORDER NUMBER	DESCRIPTION	UNIT
STARTER, 4 SHELVES, 63" POSTS		
1	RL907 30"W x 14"D x 63"H, 39 lbs	EA
2	RL059 36"W x 18"D x 63"H, 48 lbs	EA
3	RL061 48"W x 18"D x 63"H, 58 lbs	EA
4	RL067 36"W x 24"D x 63"H, 62 lbs	EA
5	RL069 48"W x 24"D x 63"H, 74 lbs	EA
6	RL071 60"W x 24"D x 63"H, 95 lbs	EA
7	RL073 72"W x 24"D x 63"H, 117 lbs	EA
ADD-ON, 4 SHELVES, 63" POSTS		
8	RL908 30"W x 14"D x 63"H, 32 lbs	EA
9	RL060 36"W x 18"D x 63"H, 35 lbs	EA
10	RL062 48"W x 18"D x 63"H, 53.5 lbs	EA
11	RL068 36"W x 24"D x 63"H, 57.7 lbs	EA
12	RL070 48"W x 24"D x 63"H, 69.5 lbs	EA
13	RL072 60"W x 24"D x 63"H, 90.5 lbs	EA
14	RL074 72"W x 24"D x 63"H, 112.5 lbs	EA
STARTER, 5 SHELVES, 74" POSTS		
15	RL909 30"W x 14"D x 74"H, 46.5 lbs	EA
16	RL075 36"W x 18"D x 74"H, 67.75 lbs	EA
17	RL077 48"W x 18"D x 74"H, 80.25 lbs	EA
18	RL083 36"W x 24"D x 74"H, 85.25 lbs	EA
19	RL085 48"W x 24"D x 74"H, 100.25 lbs	EA
20	RL087 60"W x 24"D x 74"H, 126.5 lbs	EA
21	RL089 72"W x 24"D x 74"H, 154 lbs	EA
ADD-ON, 5 SHELVES, 74" POSTS		
22	RL910 30"W x 14"D x 74"H, 39 lbs	EA
23	RL076 36"W x 18"D x 74"H, 58.25 lbs	EA
24	RL078 48"W x 18"D x 74"H, 70.75 lbs	EA
25	RL084 36"W x 24"D x 74"H, 75.75 lbs	EA
26	RL086 48"W x 24"D x 74"H, 90.75 lbs	EA
27	RL088 60"W x 24"D x 74"H, 117 lbs	EA
28	RL090 72"W x 24"D x 74"H, 144.5 lbs	EA

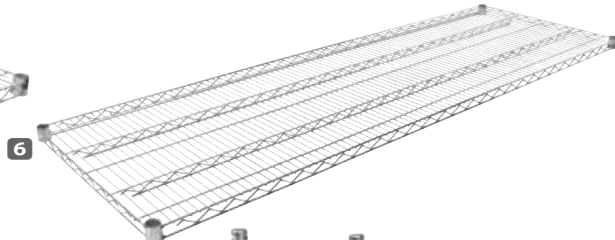
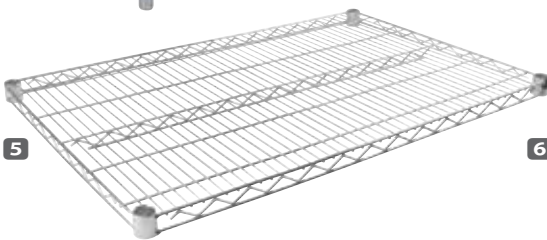

B KLETON® HEAVY DUTY WIRE SHELVING COMPONENTS

Heavy-gauge chromate plated shelves with open wire design minimize dust, improve air circulation and provide greater visibility of stored items. Post's circular grooves combined with tapered plastic split sleeves allow for assembly in minutes with no special tools. Shelf ribs run front to back allowing items to slide on and off shelves smoothly. Shelves can be adjusted at precise 1" intervals and shelf posts are double grooved every 8" and numbered for easy adjustment.

ORDER NUMBER	DESCRIPTION	UNIT
WIRE SHELVES, CAPACITY 800 LBS/SHELF		
1	RL606 30"W x 14"D, 7.5 lbs	EA
2	RL036 36"W x 18"D, 9.75 lbs	EA
3	RL037 48"W x 18"D, 12.5 lbs	EA
4	RL040 36"W x 24"D, 13.25 lbs	EA
5	RL041 48"W x 24"D, 16.25 lbs	EA
WIRE SHELVES, CAPACITY 600 LBS/SHELF		
6	RL042 60"W x 24"D, 21.5 lbs	EA
7	RL043 72"W x 24"D, 27 lbs	EA



ORDER NUMBER	DESCRIPTION	UNIT
POSTS		
8	RL331 7 lbs, 63"H	EA
9	RL332 8 lbs, 74"H	EA
5" CASTER		
10	RL048 2.8 lbs, no brake	EA
11	RL049 2.7 lbs, with brake	EA
SPLIT SLEEVES		
12	RL054 0.1 lbs., Black	4/PK
S-HOOK FOR ATTACHING ADD-ON		
13	RL055 0.1 lbs	EA

CLEANING, BREAKROOM AND FACILITIES

Facility Supplies – mirrors and crowd control

ZENITH® DOME MIRRORS

Increase surveillance and prevent accidents due to blind corners. Constructed of acrylic for added durability. Black protective edge and hanging clips.

Ideal Locations:

- 360° 4-way intersections
- 180° T-intersections
- 90° Corner intersections



A FULL DOME - 360°

Includes hanging hardware.

ORDER NUMBER	DESC.	UNIT
1	SEJ875 20" dia.	EA
2	SEJ876 24" dia.	EA
3	SEJ877 31" dia.	EA
4	SEJ878 47" dia.	EA



B HALF DOME - 180°

Includes hanging hardware.

ORDER NUMBER	DESC.	UNIT
1	SEJ879 20" dia.	EA
2	SEJ880 24" dia.	EA
3	SEJ881 31" dia.	EA
4	SEJ882 47" dia.	EA



C QUARTER DOME - 90°

Includes hanging hardware.

ORDER NUMBER	DESC.	UNIT
1	SEJ883 20" dia.	EA
2	SEJ884 24" dia.	EA

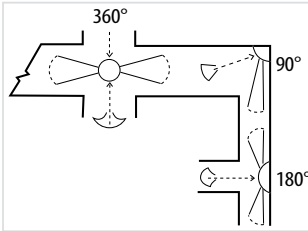

D ZENITH® CONVEX MIRRORS

Removes blind spots reducing the chance of accidents caused by blind corners. Durable acrylic with plastic back and frame. Adjustable ball and swivel mount with 100° viewing angle.



ORDER NUMBER	DESCRIPTION	UNIT
INDOOR		
1	SDP505 12" diameter	EA
2	SDP506 18" diameter	EA
3	SDP507 26" diameter	EA
4	SDP508 30" diameter	EA
5	SDP509 36" diameter	EA
OUTDOOR		
6	SDP500 12" diameter	EA
7	SDP501 18" diameter	EA
8	SDP502 26" diameter	EA
9	SDP503 30" diameter	EA
10	SDP504 36" diameter	EA

E ZENITH® CLOSED-TOP DOME MIRRORS

Removes blind spots reducing the chance of accidents caused by blind corners. Durable heavy-duty acrylic construction.



ORDER NUMBER	DESCRIPTION	UNIT
FULL DOME - 360°		
1	SDP520 18" diameter	EA
2	SDP521 26" diameter	EA
3	SDP522 32" diameter	EA
4	SDP523 48" diameter	EA
HALF DOME - 180°		
5	SDP524 18" diameter	EA
6	SDP525 26" diameter	EA
7	SDP526 32" diameter	EA
8	SDP527 48" diameter	EA

F ZENITH® WALL MOUNT BARRIERS

Ideal where floor space is essential. Slow retracting tape cassette ensures tape will retract safely. Specially designed locking mechanism prevents accidental release. Includes hardware. 7" tape length. 3"W×3"D×5"H. Black.

ORDER NUMBER	DESCRIPTION	UNIT
1	SED813 Stainless steel barrier	EA
2	SAS233 Black steel barrier	EA



G ZENITH® FREE-STANDING CROWD CONTROL BARRIERS

Four-way connection permits all posts to receive up to three tapes from any direction. Slow retracting tape cassette insures tape will retract safely. Specially designed locking mechanism prevents accidental release. Steel. 35"H×7" tape length.

ORDER NO.	DESCRIPTION	UNIT
WITHOUT WHEELS		
1	SAS229 Yellow tape-Caution Do Not Enter	EA
2	SAS228 Yellow tape	EA
3	SAS226 Red tape	EA
4	SAS227 Black tape	EA
WITH WHEELS		
5	SDN327 Black tape	EA
6	SEI764 Yellow tape	EA
7	SEI760 Red tape	EA



Use furniture polish to clean mirrors. Glass cleaner will damage surface.

Freight charges may apply. Check online for the most current price.

**A CLEAN LINE™
ECONOMY
LOCKERS**

Fully assembled, prime grade cold rolled steel locker with all-welded frame with panels and doors assembled with rivets. Pearl Grey finish. 12"W×18"D×72"H



ORDER NUMBER	DESCRIPTION	UNIT
--------------	-------------	------

SINGLE TIER

Includes one hat shelf, three coat hooks and aluminum recessed padlock handle.

1	CL-S-1-12X18X72_A124	Bank of 1	EA
2	CL-S-2-12X18X72_A124	Bank of 2	EA
3	CL-S-3-12X18X72_A124	Bank of 3	EA
4	CL-S-4-12X18X72_A124	Bank of 4	EA

DOUBLE TIER

Includes two coat hooks per opening and aluminum recessed padlock handle.

5	CL-D-1-12X18X72_A124	Bank of 1	EA
6	CL-D-2-12X18X72_A124	Bank of 2	EA
7	CL-D-3-12X18X72_A124	Bank of 3	EA
8	CL-D-4-12X18X72_A124	Bank of 4	EA

SIX TIER LOCKERETTES

Includes two coat hooks per opening and aluminum recessed padlock handle.

9	CL-L-1-12X18X72_A124	Bank of 1	EA
10	CL-L-2-12X18X72_A124	Bank of 2	EA
11	CL-L-3-12X18X72_A124	Bank of 3	EA

**C KLETON STEEL
LOCKER ACCESSORIES**

Grey paint finish.



ORDER NUMBER	DESCRIPTION	UNIT
--------------	-------------	------

1	FL374	Recess Base for lockers	EA
2	FL375	Slope Top for lockers	EA
3	FL376	Nuts & Bolts set for locker	EA
4	FL518	Number plates (Set of 1-25)	EA
5	FL519	Number plates (Set of 26-50)	EA
6	FL520	Number plates (Set of 51-75)	EA
7	FL521	Number plates (Set of 76-100)	EA



D KLETON LOCKER ROOM BENCHES

Necessary for any locker room.

ORDER NUMBER	DESCRIPTION	UNIT
--------------	-------------	------

1	FB002	Steel, 72"L×12"W×17"H, 35 lbs	EA
---	-------	-------------------------------	----

WOOD

Black powder coated legs can be used free-standing, or bolted to the floor.

2	RL871	48"L×9½"W×16½"H, 23 lbs	EA
3	RL872	60"L×9½"W×16½"H, 29 lbs	EA
4	RL873	72"L×9½"W×16½"H, 31 lbs	EA
5	RL874	96"L×9½"W×16½"H, 39 lbs	EA

**B KLETON
READY TO
ASSEMBLE
STEEL
LOCKERS**

Ships knocked down, ready to assemble with nuts and bolts included. Grey paint finish.



ORDER NUMBER	DESCRIPTION	UNIT
--------------	-------------	------

SINGLE TIER

Double pan construction doors, 20-gauge outer and 24-gauge inner pans and three zinc-plated coat hooks, 12"W×18"D×72"H.

1	FL362	Basic style, bank of 1	EA
2	FL363	Basic style, bank of 2	EA
3	FL364	Basic style, bank of 3	EA
4	FL380	Slope top, bank of 1	EA
5	FL381	Slope top, bank of 2	EA
6	FL382	Slope top, bank of 3	EA
7	FL392	Recessed base, bank of 1	EA
8	FL393	Recessed base, bank of 2	EA
9	FL394	Recessed base, bank of 3	EA
10	FL404	Slope top & Recessed base, bank of 1	EA
11	FL405	Slope top & Recessed base, bank of 2	EA
12	FL406	Slope top & Recessed base, bank of 3	EA

DOUBLE TIER

Double pan construction doors, 20-gauge outer and 24-gauge inner pans and three zinc-plated coat hooks, 12"W×18"D×33¼"H.

13	FL366	Basic style, bank of 1	EA
14	FL367	Basic style, bank of 2	EA
15	FL368	Basic style, bank of 3	EA
16	FL384	Slope top, bank of 1	EA
17	FL385	Slope top, bank of 2	EA
18	FL386	Slope top, bank of 3	EA
19	FL396	Recessed base, bank of 1	EA
20	FL397	Recessed base, bank of 2	EA
21	FL398	Recessed base, bank of 3	EA
22	FL408	Slope top & Recessed base, bank of 1	EA
23	FL409	Slope top & Recessed base, bank of 2	EA
24	FL410	Slope top & Recessed base, bank of 3	EA

LOCKERETTES

12"W×18"D×11"H.

25	FL370	Basic style, bank of 1	EA
26	FL371	Basic style, bank of 2	EA
27	FL372	Basic style, bank of 3	EA
28	FL388	Slope top, bank of 1	EA
29	FL389	Slope top, bank of 2	EA
30	FL390	Slope top, bank of 3	EA
31	FL400	Recessed base, bank of 1	EA
32	FL401	Recessed base, bank of 2	EA
33	FL402	Recessed base, bank of 3	EA
34	FL412	Slope top & Recessed base, bank of 1	EA
35	FL413	Slope top & Recessed base, bank of 2	EA
36	FL414	Slope top & Recessed base, bank of 3	EA

Shipping Supplies



A DYMO® M5 MAILING & SHIPPING SCALE

"Hold" function locks the weight display for 10 seconds after the package is removed, useful when a large package blocks view of the display. For items weighed in a container, the "tare" function subtracts the weight of the container, showing only the weight of the items. Automatic shut-off when scale is not in use prolongs battery life. 5 lb. mailing scale: capacity up to 2.2 kg (5 lb.); displays weight in 0.1 oz increments; powered by 3 AAA batteries (included).

ORDER NUMBER	UNIT
1772056	EA



B DYMO® M25 MAILING & SHIPPING SCALE

"Hold" function locks the weight display for 10 seconds after the package is removed, useful when a large package blocks view of the display. For items weighed in a container, the "tare" function subtracts the weight of the container, showing only the weight of the items. Automatic shut-off when scale is not in use prolongs battery life. 25 lb. mailing scale: capacity up to 11 kg (25 lb.); displays weight in 2 oz increments; runs on 3 AAA batteries (not included) or USB power from computer (USB cable included). Works with Windows®, XP, Windows Vista®, Windows 7® and Mac OS® v10.4 or later.

ORDER NUMBER	UNIT
1772059	EA



C DYMO® S100 MAILING & SHIPPING SCALE

"Hold" function locks the weight display for 10 seconds after the package is removed, useful when a large package blocks view of the display. For items weighed in a container, the "tare" function subtracts the weight of the container, showing only the weight of the items. Automatic shut-off when scale is not in use prolongs battery life. 100 lb. shipping scale: capacity up to 45 kg (100 lb.); displays weight in 0.2 lb. increments; detachable LCD display for hand-held/wall mounted viewing; runs on USB power from computer (USB cable included), AC adapter (included) or AAA batteries (not included). Works with Windows®, XP, Windows Vista®, Windows 7® and Mac OS® v10.4 or later.

ORDER NUMBER	UNIT
1776111	EA



D DYMO® S250 DIGITAL SHIPPING SCALE

Carry the scale to heavy packages, not vice-versa, with convenient built-in wrap-around handle. Compatible with various online mailing and shipping software - including Endicia® InstaRate and DYMO Stamps® software. Featuring convenient hold, tare and automatic shut-off functions. Detachable LCD display. USB interface. 113 kg (250 lb) capacity. AC or USB power. Includes USB cable and adaptor. Uses 3 "AAA" batteries (not included).

ORDER NUMBER	UNIT
1776112	EA



E KILOTECH RECEIVING SCALE

Heavy-duty, general purpose scale suitable for light industrial or shipping applications. Features kg/lbs modes, programmable auto-off function. Fixed mild steel checkered platform. Zero, tare and kg/lbs toggle keys, Heavy-duty 8' coiled cord. 3" x 1-1/4" LCD display. 68 kg (150 lb) capacity. 0.2 lbs./100g graduation. Platform size: 11 3/4" x 12 1/4". 1-year warranty.

ORDER NUMBER	UNIT
IA564	EA

F SAFCO® WIRE MAIL CART

Welded wire construction with convenient dual handles. Top basket holds legal file folders, lower basket (18" D) easily accommodates parcels. Four 4" diameter swivel casters, two locking. Durable metallic grey powder coat finish; easy assembly. Capacity: 600 lb. Greenguard certified. 24" cart 26 3/4" W x 18 3/4" D x 38 1/2" H



ORDER NUMBER	UNIT
5235GR	EA

CLEANING, BREAKROOM AND FACILITIES

C MERANGUE® SHIPPING TAGS

Light manila with reinforced eyelet for maximum strength.



ORDER NUMBER	DESCRIPTION	UNIT
100/PK		
1	1024-4721-00-000 #1, 2¾"×1⅜"	100/PK
2	1024-5061-00-000 #3, 3¾"×1⅞"	100/PK
3	1024-5071-00-000 #4, 4¼"×2⅛"	100/PK
4	1024-4711-00-000 #5, 4¾"×2⅜"	100/PK
5	1024-5051-00-000 #6, 5¼"×2⅝"	100/PK
1000/PK		
6	1024-4070-00-000 #1, 2¾"×1⅜"	1000/PK
7	1024-4080-00-000 #2, 3¼"×1⅝"	1000/PK
8	1024-4090-00-000 #3, 3¾"×1⅞"	1000/PK
9	1024-4100-00-000 #4, 4¼"×2⅛"	1000/PK
10	1024-4110-00-000 #5, 4¾"×2⅜"	1000/PK
11	1024-4120-00-000 #6, 5¼"×2⅝"	1000/PK

C SHIPPING TAGS

Strong and durable. Use a pen, pencil or marker.



ORDER NUMBER	DESCRIPTION	UNIT
1	SHIPTYEL5 #5, 4¾"×2⅜", Yellow	1000/CT
2	SHIPT5 #5, 4¾"×2⅜", White	1000/CT
3	SHIPTYEL8 #8, 6¼"×3⅛", Yellow	1000/CT
4	SHIPT8 #8, 6¼"×3⅛", White	1000/CT

E MERANGUE® TAG WIRE

Securely attaches shipping tags. 12"

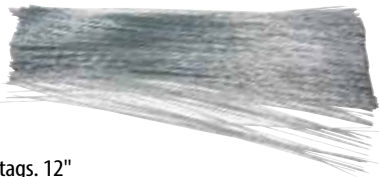

ORDER NUMBER	UNIT
1024-5091-00-000	1000/PK

F MERANGUE ALL PURPOSE FASTENERS

Plastic tag fasteners. 5" long. Clear.



ORDER NUMBER	UNIT
1024-4031-00-000	200/PK

NEW!

B VERA PLASTICS POUND BAGS

Made of 100% low density polyethylene. Transparent with superior clarity. Visible storage and protection. 100/box.



ORDER NUMBER	DESCRIPTION	UNIT
1	48-220 2 lb, 4"W×2"D×10"H	BX
2	48-230 3 lb, 5"W×3"D×11"H	BX
3	48-250 5 lb, 5"W×3"D×14"H	BX
4	48-310 10 lb, 7"W×3"D×20"H	BX



D RECLOSABLE BAGS

With white block panel. 100 per pack.

ORDER NUMBER	DESCRIPTION	UNIT
1	RECPBWB223 2"×3"	PK
2	RECPBWB235 3"×5"	PK
3	RECPBWB246 4"×6"	PK
4	RECPBWB269 6"×9"	PK
5	RECPBWB2912 9"×12"	PK

G CROWNHILL® TWINE

Multi-use white twine. Poly/cotton blend. 100m / 328'. Great for wrapping, bundling and securing.



ORDER NUMBER	UNIT
026144	EA

Shipping Supplies

A INDUSTRIAL THERMAL LABELS

Ideal for shipping labels, bar codes, ID labels, price labels and tags. Perforated for easy application to cartons and skids. 4"×6". White. 1000 labels/roll.



ORDER NUMBER	DESCRIPTION	UNIT
1 3420025D	Direct Thermal, fits most direct transfer printers	RL
2 THETL46WR	Thermal Transfer, fits most thermal transfer ribbon printers	RL



C PEEL AND STICK LABEL ROLLS

Easy peel labels save time. Bold colours stand out for maximum awareness. Bilingual.

ORDER NUMBER	DESCRIPTION	UNIT
1 LABEF101R	Fragile Handle with Care, 5"W×3"H, Red/White	500/RL
2 LABEF134R	This Side Up, 5"H×3"W, Red/White	500/RL
3 LABRW215R	Made in Canada, 1" Circle, Red/White	1000/RL

E SELF SEAL POLY ENVELOPES

Poly envelopes are strong and tear resistant. Double perforation for easier opening. Open end. White.



ORDER NUMBER	DESCRIPTION	UNIT
1 139386	10"×13"	100/CT
2 139394	12"×15½"	100/CT
3 139360	14½"×19"	100/CT

G SURVIVOR® TYVEK® CATALOGUE ENVELOPES

No-lick, instant-stick, convenient Redi-Seal® closure, made of DuPont™ Tyvek®; moisture and tear resistant.

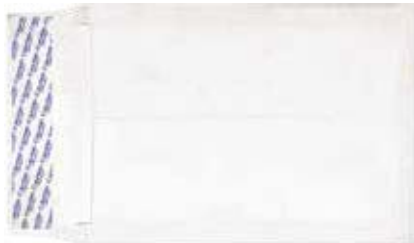

ORDER NUMBER	DESCRIPTION	UNIT
1 QUAR1790	12"×15½"	100/PK
2 QUAR4500	10"×13"×1½", end expansion	100/PK



B MAILING TUBES WITH END CAPS FROM SPICERS

100% post-consumer recycled material, excluding plastic caps. White.



ORDER NUMBER	DESCRIPTION	UNIT
1 MAITBEC224	24"×2" diameter	25/CT
2 MAITBEC336	36"×3" diameter	30/CT

D SQUARE MAILING TUBES FROM SPICERS

Shipped flat.



ORDER NUMBER	DESCRIPTION	UNIT
1 MAITBSMT325	3"×3"×25"	EA
2 SHIC744279	3"×3"×30"	EA
3 MAITBSMT337	3"×3"×37"	EA



F CRIMPED MAILING TUBES FROM SPICERS

Kraft. 25/carton.



ORDER NUMBER	DESCRIPTION	UNIT
1 MAITBC218	18"×2"	25/CT
2 MAITBC224	24"×2"	25/CT
3 MAITBC230	30"×2"	25/CT



H EDGE ENVELOPE INSERTS

Padding board used for mailing documents, photos and artwork without worry of bending. Contains a minimum of 90% post-consumer recycled material.



ORDER NUMBER	DESCRIPTION	UNIT
6413001	8½"×11"	25/PK

A SPICERS POLY MAILERS

Combined strength and versatile courier envelope with bubble cushioning. Features hot melt self seal closure.



ORDER NUMBER	DESCRIPTION	UNIT
1 XPAK0	#0, 6½"×10"	250/BX
2 XPAK1	#1, 7¼"×12"	100/BX
3 XPAK2	#2, 8½"×12"	100/BX
4 XPAK4	#4, 9½"×14½"	100/BX
5 XPAK5	#5, 10½"×16"	100/BX
6 XPAK6	#6, 12¼"×18"	50/BX
7 XPAK7	#7, 14"×19"	50/BX

NEW!
NEW!



NEW!

C SUPREMEX CONFORMER® CORRUGATE MAILER

Extremely durable capacity with ultimate strength to protect products during shipment. Features easy open tearstrip. 2" capacity. Natural Kraft.

ORDER NUMBER	DESCRIPTION	UNIT
1 CPB	9¼"×12¼"	25/PK
2 HDC3X	11¾"×14½"	25/PK



NEW!

E STAYFLAT® MAILERS

Eliminates the need for cardboard stiffeners. Keeps product flat during shipping. Contains a minimum of 35% post-consumer recycled content. White.

ORDER NUMBER	DESCRIPTION	UNIT
LOCKING TAB		
1 STAF002	6"×8"	100/CT
2 STAF003	9"×11½"	100/CT
3 STAF004	9¾"×12¼"	100/CT
4 STAF005	11"×13½"	100/CT
5 STAF006	12¾"×15"	100/CT
6 STAF007	13"×18"	100/CT
LIP AND SEAL		
7 STAFP002	6"×8"	100/CT
8 STAFP003	7"×9"	100/CT
9 STAFP004	9"×11½"	100/CT
10 STAFP005	9¾"×12¼"	100/CT
11 STAFP007	12¾"×15"	100/CT
12 STAFP008	13"×18"	100/CT

B BUBBLE MAILERS

Self-sealing shipping bags with ⅜" plastic air bubble liner. Lightweight to reduce postage. FSC® certified.



ORDER NUMBER	DESCRIPTION	UNIT
1 EDGBM002	#000, 3¾"×7"	10/PK
2 EDGBM003	#00, 4.85"×9"	10/PK
3 EDGBM004	#0, 6½"×9"	10/PK
4 EDGBM005	#1, 7"×11"	10/PK
5 EDGBM006	#2, 8¼"×11"	10/PK
6 EDGBM007	#3, 8¼"×13½"	10/PK
7 EDGBM008	#4, 9¼"×13½"	10/PK
8 EDGBM009	#5, 10¼"×15"	10/PK
9 EDGBM010	#6, 12¼"×18"	10/PK
10 EDGBM011	#7, 14"×19"	10/PK
11 ELSS0	#0, 6"×10"	250/BX
12 ELSS2	#2, 8½"×12"	100/BX
13 ELSS4	#4, 9½"×14½"	100/BX
14 ELSS5	#5, 10½"×16"	100/BX
15 ELSS6	#6, 12½"×19"	50/BX
16 ELSS7	#7, 14½"×20"	50/BX

D CONFORMER® PAPERBOARD MAILERS

The eco-friendly 14 pt. white board Conformer® offers 360° perimeter protection – no shifting, no corner damage.



ORDER NUMBER	DESCRIPTION	UNIT
1 C2	9¾"×12¼", ⅝" expansion	EA
2 C4	11½"×13¾", 1½" expansion	EA

NEW!

F IPG CURBY MAILER™

The latest and most innovative protective mailer on the market. Made from recycled and recyclable paper, this mailer is lined with HexcelWrap™ – an innovative, patent-pending cushioning material. Features ultimate honeycomb cushioning, curbside recyclable.



ORDER NUMBER	DESCRIPTION	UNIT
1 1414001	#2, 9½"×9⅞"×11⅜"	80/CT
2 1414002	#5, 15½"×9⅞"×11⅜"	80/CT
3 1414003	#6, 18½"×11⅞"×13⅜"	80/CT

CLEANING, BREAKROOM AND FACILITIES

Shipping Supplies



A KRAFT CORRUGATED SHIPPING CARTONS

Standard single wall carton for packing and shipping with a preprinted item content panel. Weight capacity 65 lbs.

ORDER NUMBER	DESCRIPTION	UNIT
1 SHIC1043	1.5 cu ft, 16"W×13"D×13"H	20/PK
2 SHIC48578	2.0 cu ft, 18"W×15"D×12½"H	20/PK
3 SHIC1044	3.1 cu ft, 18"W×18"D×16"H	15/PK



KRAFT CORRUGATED TALL SHIPPING BOXES

Contains a minimum of 80% post consumer recycled material.

4 SHIC5352	16"W×16"D×36"H	10/PK
------------	----------------	-------



D CORRUGATED BOXES

200 lb test. Contains a minimum of 80% post-consumer recycled material.

ORDER NUMBER	DESCRIPTION	UNIT
1 SHIC743737	24"×18"×18"H	10/PK
2 SHIC355490	6"×6"×6"H	25/PK
3 SHIC355491	8"×8"×8"H	25/PK
4 1855022	10"W×7"D×5"H	25/PK
5 SHIC355493	10"W×10"D×10"H	25/PK
6 SHIC741941	11"W×9"D×9"H	25/PK
7 SHIC743735	11¾"W×8¾"D×4¾"H	25/PK
8 1855140856	12"W×6"D×6"H	25/PK
9 SHIC232043	12"W×9"D×4½"H	25/PK
10 1804005B	12"W×9"D×6"H	25/PK
11 SHIC3908	12"W×9"D×9"H	25/PK
12 SHIC741944	12"W×12"D×12"H	25/PK
13 SHIC254256	14"W×10"D×10"H	25/PK
14 SHIC541759	15"W×9"D×9"H	25/PK
15 SHIC232234	18"W×12"D×9"H	25/PK
16 SHIC308500	20"W×14"D×12"H	25/PK



HEAVY DUTY SHIPPING BOXES

17 SHIC2921	12"W×9"D×9"H	15/PK
18 SHIC2920	18"W×12"D×9"H	25/PK

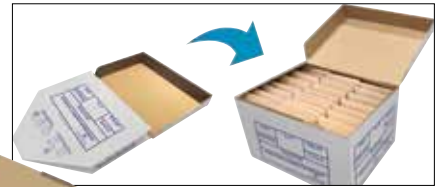

B SPICERS READYPACK™ STORAGE BOXES

Easy to assemble boxes with an 80% smaller footprint than a standard box and with cut out handles. Flip-top lid. Letter or legal size. 12"W×15"D×10"H. 12 boxes/pkg.

Kraft contains a minimum of 70% post-consumer recycled material. 400 lb. stacking strength.

White contains a minimum of 80% post-consumer recycled material. 650 lb. stacking strength.

ORDER NUMBER	DESCRIPTION	UNIT
1 SHIC0715K	Kraft	12/PK
2 SHIC0716W	White	12/PK



C READYPACK™ SELF SEAL SHIPPING BOXES

Manufactured using new patented, pre-assembled technology that allows you to easily set up or break down these boxes. Contains a minimum of 80% post-consumer recycled material. Kraft.



ORDER NUMBER	DESCRIPTION	UNIT
1 SHIC2631	Small, 12"W×9"D×5"H	12/PK
2 SHIC2632	Medium, 15"W×12"D×8"H	12/PK

E PORTA PACK POLY STRAPPING KIT

Portable polypropylene strapping kits will secure skids, boxes and tubing anywhere in the warehouse. Easy to carry case with storage for buckles. No tools required. Includes strapping, buckles and cutter. ½"×3300' poly strapping. 300 buckles/kit.



ORDER NUMBER	UNIT
PS00297	KT



A EDGE® RECYCLED BUBBLE PACKAGING

Contains a minimum of 25% post-consumer recycled material; 3/8" diameter bubbles, 3/16" thick; light green.



ORDER NUMBER	DESCRIPTION	UNIT
BUBB3161225	12"×25'	RL

C EDGE® PACKAGING AIR PILLOWS

Prefilled transparent air pillows allow product to be seen while secured. Perforated for easy separation. 8"×5". 150/box.



ORDER NUMBER	UNIT
IE0193	150/BX

E NEWSPRINT WRAPPING PAPER

Clean newsprint paper. Ideal for wrapping, packing and shipping.



ORDER NUMBER	DESCRIPTION	UNIT
1 NEW2424	24"×24" sheet	120/PK
2 NEWSR24	24"×1200' roll	RL

G KRAFT WRAPPING PAPER

ORDER NUMBER	DESCRIPTION	UNIT
1 KRAMFRNAT3024	24"×1200', 30 lb.	RL
2 KRAMFRNAT3030	30"×1200', 30 lb.	RL
3 KRAMFRNAT3036	36"×1200', 30 lb.	RL
4 80003CRO	30"×39.4', 40 lb.	RL

KRAFT PAPER ROLL DISPENSER

5 KRARDISP24	24"	EA
6 KRARDISP30	30"	EA
7 KRARDISP36	36"	EA



B EDGE® BUBBLE CUSHION PACKAGING

Protective rolls for fragile objects. Cushion consists of 3/8" bubbles, 3/16" thick. Ideal for shipping.

ORDER NUMBER	DESCRIPTION	UNIT
1 4200004	12"×15'	RL
2 4200005	12"×175', includes dispenser	BX

D BUBBLE WRAP

Protective rolls provide cushioning and protection for fragile objects. Perforated every 12". 3/8" bubbles.

ORDER NUMBER	DESCRIPTION	UNIT
1 BUBW24300P12S24	24"×300'L 2/PK	
2 BUBW48300P12	48"×300'L 1/PK	



F SCOTCH™ CUSHION LOCK PROTECTIVE WRAP

Sustainable expanding paper wrap that cushions, immobilizes and conforms to your item for superior protection. 100% recycled content and fully curbside recyclable.

ORDER NUMBER	DESCRIPTION	UNIT
1 PCW-121000	12" x 1000' roll	RL
2 PCW-121000-D	Dispenser	EA



VMAXX FEATURE



A VMAXX PRESTRETCH HAND WRAP

Cast 5-layer stiff hand wrap designed for easy down gauging and cost savings over thicker standard hand wrap films. Maintains load containment while reducing film usage. Exceptional puncture resistance.

ORDER NUMBER	DESCRIPTION	UNIT
1 PS00326	15"×1476' 60 Gauge	4/CT
2 PS00490	18"×1476' 60 Gauge	4/CT
3 PS00624	15"×1476' 65 Gauge	4/CT



D PRE-STRETCH CORELESS BANDING WRAP

Save up to 20% using pre-stretch film vs conventional film when wrapping. No paper core which reduces waste and roll weight. Includes 1 reusable handle. 5"×1000'.

ORDER NUMBER	UNIT
PS00627	12/CT

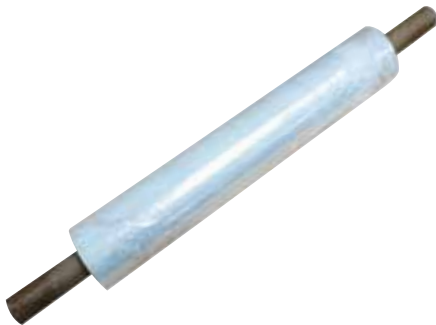

F HAND STRETCH CAST WRAP

Extended core. Quiet unwind. Allows maximum coverage. Clings to itself. Leaves no residue. Ability to stretch 200%. 80G. 20"×1000'.

ORDER NUMBER	UNIT
PS00324	EA



G MANUAL HAND WRAP ROLL DISPENSER

Prevents finger friction burns. Two end pieces fit into the core of stretch wrap. Fits 3" core.

ORDER NUMBER	UNIT
PS00569	EA



B PLATINUM MAX HAND FILM

Quiet unwind. Higher holding force with lowest gauge. High puncture resistance. Clear.

ORDER NUMBER	DESCRIPTION	UNIT
1 PS00492	14"×1476', 65 gauge	4/CT
2 PLAMH001	17.7"×1476', 65 gauge	NEW! 4/CT
3 PS00494	14"×1476', 80 gauge	4/CT
4 PS00668	17.7"×1476', 80 gauge	NEW! 4/CT



C SIGMA® STRETCH WRAP

Cellophane stretch wrap for secure bundling of skids of cartons. 80 gauge.

ORDER NUMBER	DESCRIPTION	UNIT
1 HBH141580	14"×1500', Clear	4/CT
2 HAA151580	15"×1500', Black	4/CT
3 HW58048	5"×1500', Clear	NEW! 12/BX

E CROWN HILL STRETCH WRAP WITH DISPENSER

General purpose, tear resistant, 80 gauge clear handheld super stretch wrap. 5"×1000'.

ORDER NUMBER	UNIT
80005	EA



H HAND STRETCH WRAP DISPENSER

Heavy-duty construction. Tension and control knobs to adjust to size of roll and a bottom core holder keeps film in place. Adjustable handle. Accommodates 12" to 20" rolls.

ORDER NUMBER	UNIT
STRWDISP	EA





A 3M™ TARTAN™ BOX SEALING TAPE

Width: 48 mm. Clear.

ORDER NUMBER	DESCRIPTION	UNIT
1 3690-48X50-CLR-1PK	3690, 50m	RL
2 3690-48X50-CLR-6PK	3690, 50m	6/PK
3 369-48X100-CLR	369, 100 m	RL



B SCOTCH® HEAVY DUTY SHIPPING PACKAGING TAPE

Shipping tape resists slivering, splitting and tearing and is 40% stronger than acrylic tapes. 3.1 mil. Clear, 48 mm×50 m.

ORDER NUMBER	UNIT
1 3850-ESF	RL
2 3850-6-ESF	6/PK

C SCOTCH® PRINTED MESSAGE TAPE

Scotch® 3772 tape was developed to help reduce product damage throughout the shipping process. Printed with: FRAGILE, HANDLE WITH CARE.



ORDER NUMBER	DESCRIPTION	UNIT
3772-48X100	48 mm×100 m	RL



D SCOTCH® 373 PREMIUM BOX SEALING TAPE WITH DISPENSER

Great for recycled cartons. High performance box sealing tape in a handy reusable dispenser. 2.5 mil. 48 mm×50 m. Clear.

ORDER NUMBER	UNIT
373-48X50-CLR-RD	EA



E SCOTCH® TOUGH GRIP MOVING PACKAGING TAPE

Hot melt adhesive for super strong tape that will securely seal moving boxes. Resists slivering, splitting and tearing and is easy to unwind. 2.6 mil. Clear, 48 mm×50 m.

ORDER NUMBER	UNIT
1 3500-ESF	RL
2 3500-6-ESF	6/PK



F SCOTCH® STORAGE TAPE

Clear-to-the-core moving and storage tape ideal for long-term storage, label protection and light-duty shipping. Holds securely over a wide range of temperatures and is UV-resistant, preventing it from breaking down over time. Creates a bond to its surface that gets stronger with time. Clear, 48 mm×50 m.

ORDER NUMBER	UNIT
3650-ESF	RL



G SCOTCH® HEAVY DUTY SHIPPING TAPE WITH DISPENSER

Great in the office or for mobile workers on the go. 3.0 mil. 48 mm×20.3 m.

ORDER NUMBER	UNIT
142-ESF	EA



H 3M™ TARTAN™ BOX SEALING TAPE

General purpose tape for light to medium weight boxes. Suitable for cold temperature applications. 48 mm x 100m. Clear.

ORDER NUMBER	UNIT
305-48X100-CLR	RL



I SCOTCH® REINFORCED STRAPPING SHIPPING TAPE

Fibreglass reinforced for heavy jobs. Can handle weight greater than 100 lbs. Strong, durable hot melt adhesive seals and protects. 48 mm×27.4 m. Clear.

ORDER NUMBER	UNIT
8950-EF-8CC	RL

Shipping Supplies



A WESTCOTT® TAPE DISPENSER

Heavy-duty, lightweight construction with adjustable clutch. Holds 2" tape.

ORDER NUMBER	UNIT
65956-80016	EA



B TARTAN™ PACKAGING TAPE DISPENSER

Heavy duty dispenser designed for one-handed quick application of up to 2" wide (48 mm) box sealing tape with 3" core.

ORDER NUMBER	UNIT
HB-903	EA



C WESTCOTT® ANTIMICROBIAL TAPE DISPENSER

Plastic parts contain an antimicrobial agent to help inhibit the growth of bacterial stains and odour. Features safety repositionable blade that is concealed until use. Adjustable clutch. Side loading design for easy tape change. Holds 2" tape rolls.

ORDER NUMBER	UNIT
65956-80017	EA



D EXTRA WIDE PACKAGING TAPE AND DISPENSER

Lightweight and easy to operate dispenser. Holds 3" wide packing tape (not included).

ORDER NUMBER	DESCRIPTION	UNIT
1 QPC306	Dispenser	EA
2 CARSTCLE4250066	Clear tape 72 mm(3")×132m	RL



E BETTER PACK® H-35 MANUAL 333 PLUS TAPE DISPENSER

Water activated. Trouble free. Easy to clean. Dispenses tape up to 30" long. Heavy-duty steel frame with minimal moving parts. Fits tape widths 1½"-3" wide.

ORDER NUMBER	DESCRIPTION	UNIT
1 IE0146	Dispenser	EA
2 K9001	Tape, 70mm (2¾") wide	10/CT



F NO PRINT PACKING SLIP ENVELOPES

Everyday envelopes keep those important documents in place on your shipment. They are self adhesive, water resistant and transparent. Made from 2ml clear poly with a white liner.

ORDER NUMBER	DESCRIPTION	UNIT
1 4800005	4½"×5½"	1000/CT
2 4800011	5½"×10"	1000/CT
3 4800007	7"×10"	1000/CT
4 4800004	9½"×12½"	500/CT



G GEO® PACKING SLIP ENVELOPES

ORDER NUMBER	DESCRIPTION	UNIT
1 90083	Half window, 4½"×5½"	100/PK
2 02000	Half window, 4½"×5½"	1000/BX
3 02100	Full window, clear, 5½"×10"	100/PK
4 50090	Full window, clear, 9½"×13"	100/PK

Furniture

Boardroom Furniture	600-601
Bookcases and Cabinets.	597-598
Cafeteria & Coffee Tables.	602-604
Chairmats.	548-549
Chairs.	516-533
Chairs - Guest & Specialty.	534-543
Coat Hooks & Stands.	593
Gaming	544
Desks & Workstations.	557-587
Fabric Swatches.	546-547
Files.	608-611
Laminate Options.	606
Machine Stands.	599
Privacy Panels.	594-596
Reception Suites.	588-592
Safes.	614-615
Sit/Stand Desks & Convertors.	550-556
Storage Cabinets.	612-613
Tables.	602-605



format

support where you need it



Featuring an adjustable headrest and a comfortable clean design, Format™ is the go-to chair for work and home offices. There's more than meets the eye; hidden within the chair's sleek profile, Format is designed and tested to provide ergonomic support at commercial quality, and a great price.

OfficestoGo

OFFICESTOGO.COM

Office Chair Buying Guide



Multi-Tilter

The most ergonomic choice. Seat and back can be adjusted independently. Tilt tension and height adjustment are standard. Typically has many more adjustable features.



Synchro-Tilter

Like the Multi, but fewer paddle adjusters. Seat and back synchronize at a 2:1 ratio. If back reclines 30°, seat tilts forward 15° to reduce thigh stress.



Tilter

Tilter chairs are a popular choice for management and meeting rooms. The chair tilt lock allows you to lock your chair in a comfortable and supportive position.



XL

These chairs are created for heavy-duty use. They are perfect for areas in shift rotation or for extended use. Reinforced for added strength, they have a double-clutch system and use high-density foam.

Customize your chair with our wide range of fabrics. See the selection on pages 546-547



Task

Non-tilting chairs ideal for short-duration workstations. Perfect for the home office, warehouse other areas where the user sits for a short period of time. They typically come with seat and back height adjustment.

Chairs – multi-tilter



1 Shown in Bonded Leather BL20

3 Shown in Fusion fabric FU85 Carbon

6 Shown in Fusion fabric FU85 Carbon

NEW!

FUSION FABRIC COLOUR



BONDED/LEATHER



A BASICS® ERGO BOSS™ MULTI-TILTER CHAIRS

Innovative chair designed to accommodate every body shape and task. Soft descent pneumatic seat height adjustment, seat depth adjustment, independent seat and back angle adjustment, infinitely adjustable seat angle, adjustable back angle, back height adjustment and articulating arm caps.

ERGONOMIC FEATURES:

A B C D E F G H M N Q R S V

ORDER NUMBER	DESCRIPTION	UNIT
EXECUTIVE BACK		
1 2869-3 BL20 BLK G6 HP	Standard seat, bonded leather	EA
2 2869-3 FU85 BLK G6 HP	Standard seat, fabric	EA
3 2870-3 FU85 BLK G5 HP	Generous seat, fabric	EA
HIGH BACK		
4 2872-3 BL20 BLK G6 HP	Lumbar pressure adjustment, bonded leather	EA
5 2872-3 FU85 BLK G6 HP	Standard seat, fabric	EA
MEDIUM BACK		
6 2874-3 FU85 BLK G6 HP	Petite seat, fabric	EA

Shown in Bonded Leather



NEW!

B BASICS® OBUSFORME® ELITE XL MULTI-TILTER CHAIR

All the benefits of the OBUSforme® series in an XL version to accommodate users of above average height and/or weight. Soft descent pneumatic seat height adjustment, seat depth adjustment, independent seat and back angle adjustment, infinitely adjustable seat angle, adjustable back angle, 53" high back, tilt tension adjustment, and arms that adjust from 22" to 26" apart.

ERGONOMIC FEATURES:

A B C D E F G H M N Q R S U

ORDER NUMBER	DESCRIPTION	UNIT
2751-3 BL20 BLK G3 HP	Extra tall high back, bonded leather	EA

FUSION FABRIC COLOUR



C BASICS® OBUSFORME® ELITE MULTI-TILTER CHAIRS

Soft descent pneumatic seat height adjustment, seat depth adjustment, independent seat and back angle adjustment, infinitely adjustable seat angle, back height adjustment, tilt tension adjustment and articulating arm caps.

ERGONOMIC FEATURES:

A B C D E F G H M N Q R S U

ORDER NUMBER	DESCRIPTION	UNIT
1 2770-3 FU85 BLK G5 HP	High back, standard seat	EA
2 2771-3 FU85 BLK G5 HP	Medium back, standard seat	EA
3 2770P-3 FU85 BLK G5 HP	High back, petite seat	EA
4 2771P-3 FU85 BLK G5 HP	Medium back, petite seat	EA
LUMBAR PRESSURE ADJUSTMENT		
5 2776-3 FU85 BLK G5 HP	High back, standard seat	EA
6 2777-3 FU85 BLK G5 HP	Medium back, standard seat	EA



1 Shown in Fusion fabric FU85 Carbon

NEW!

- A TENSION ADJUSTMENT
- B CHAIR TILT LOCK
- C SEAT HEIGHT
- D BACK/LUMBAR HEIGHT
- E SEAT DEPTH
- F SEAT ANGLE ADJUSTMENT

- G BACK ANGLE
- H ARM HEIGHT
- I ARM ANGLE
- J KNEE-TILT MOVEMENT
- L SYNCHRO-TILT MOVEMENT
- M WATERFALL SEAT EDGE

- N PROPERLY CONTOURED CUSHIONS
- P VIBRATING BACK / SEAT
- Q WIDTH ADJUSTABLE ARMS
- R ARM ROTATION
- S CENTRE-TILT MOVEMENT

- T PUSH BUTTON
- U SOFT DESCENT PNEUMATIC LIFT
- V LUMBAR DEPTH ADJUSTMENT

518 Call for more model & fabric selections. Freight charges may apply. Check online for the most current price.

Chairs – multi-tilter



3
Shown in Terrace fabric TC74 Echo

TERRACE FABRIC COLOURS



Supports users between 225 and 400 lbs.

A GLOBAL® OBUSFORME COMFORT XL™ CHAIRS

Designed to accommodate the big and tall user. The high quality Soft Descent™ pneumatic lift will support users from 225 to 400 pounds. Allows you to adjust the space between the arms from 22" to 26" apart. Tall users will benefit from the added seat depth (an extra 1.5" deeper than standard), the 2.5" seat slider adjustment and the extra tall 53" ratchet style back with no pressure points along the spine. The torque requirement automatically changes for each user, without the need for any manual adjustment. Terrace fabric.

ERGONOMIC FEATURES:

A B C D E F G H M N O R S U

ORDER NUMBER	DESCRIPTION	UNIT
1 1251-3 TC74 BLK G3 HP	Extended high back, wide & deep multi-tilter	EA
2 1253-3 TC74 BLK G3 HP	Medium back, wide & deep multi-tilter	EA
3 1254-3 TC74 BLK G3 HP	Extended high back, wide standard depth multi-tilter	EA



TERRACE FABRIC COLOURS



Shown in Terrace fabric TC74 Echo

B OBUSFORME® MULTI-TILTER OFFICE CHAIRS

Complete back support promotes better sitting habits which helps to increase user comfort and productivity. Obusforme® chairs have individual adjustments for seat height, back height and angle. Infinite position locking on the tilter mechanism. Seats and back are contoured surfaces using twin density molded foam for additional support. Ultimate adjustable arms. Terrace fabric.

ERGONOMIC FEATURES:

A B C D E F G H M N Q R S

ORDER NUMBER	DESCRIPTION	UNIT
1 4430 TC74 BLK G3 HP	High back, with lumbar pad/headrest	EA
2 4432 TC74 BLK G3 HP	Medium back multi-tilter	EA



Shown in Silhouette fabric SL30 Charcoal



TERRACE FABRIC COLOURS

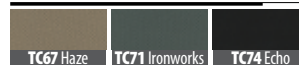

C GLOBAL™ TRITEK® ERGO SELECT CUSTOMIZED MULTI-TILTER CHAIRS

Designed with a choice of three sizes of seats and backs to accommodate every body shape and task. Special comfort memory foam "spine pad" incorporated into the back molds to the back shape, reducing pressure points along the spine. Ultimate adjustable arms, height and depth adjustable lumbar area. Terrace fabric.

ERGONOMIC FEATURES:

A B C D E F G H M N Q R S U V

ORDER NUMBER	DESCRIPTION	UNIT
1 7472-3 G2 TC74 BLK	Extended high back, standard seat	EA
2 7482-3 G2 TC74 BLK	High back, standard seat	EA
3 7491-3 G2 TC74 BLK	Medium back, small seat	EA

Chairs – multi-tilter



TERRACE FABRIC COLOURS

TC67 Haze	TC71 Ironworks	TC74 Echo	BL20 Black
-----------	----------------	-----------	------------

BONDED/LEATHER

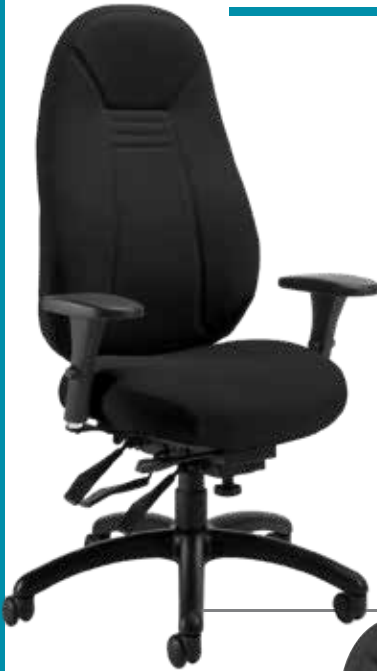

Shown in
Terrace fabric
TC74 Echo

GLOBAL® OBUSFORME® COMFORT CHAIRS

This series features an elastomeric back support system and new Soft Descent gentle seat height adjustment and provides impressive comfort support with no pressure points along the spine and compound curved back and seat. Models are standard with 5¼" ratchet back for height adjustment of the lumbar support and the ultimate height and width adjustable G3 arms. Infinitely adjustable seat angle with forward and rearward incline. Seat depth adjustment.

A OBUSFORME® COMFORT CHAIR WITH SCHUKRA™ LUMBAR SUPPORT

ERGONOMIC FEATURES:

A B C D E F G H M N Q R S U

ORDER NUMBER	DESCRIPTION	UNIT
1 1260-3 TC74 BLK G3 HP	High back multi-tilter, fabric	EA
2 1260-3 BL20 BLK G3 HP	High back multi-tilter, bonded leather	EA
3 1261-3 TC74 BLK G3 HP	Medium back multi-tilter, fabric	EA
4 1261-3 BL20 BLK G3 HP	Medium back multi-tilter, bonded leather	EA

TERRACE FABRIC COLOURS

TC67 Haze	TC71 Ironworks	TC74 Echo	BL20 Black
-----------	----------------	-----------	------------

BONDED/LEATHER

Shown in
Terrace fabric
TC74 Echo



B OBUSFORME® COMFORT SERIES MULTI-TILTER CHAIRS

ERGONOMIC FEATURES:

A B C D E F G H M N Q R S U

ORDER NUMBER	DESCRIPTION	UNIT
1 1240-3 TC74 BLK G3 HP	High back, fabric	EA
2 1240-3 BL20 BLK G3 HP	High back, bonded leather	EA
3 1241-3 TC74 BLK G3 HP	Medium back, fabric	EA
4 1241-3 BL20 BLK G3 HP	Medium back, bonded leather	EA



Shown in
Terrace fabric
TC74 Echo

Supports users
up to 350 lbs.

TERRACE FABRIC COLOURS

TC67 Haze	TC71 Ironworks	TC74 Echo	BL20 Black
-----------	----------------	-----------	------------

BONDED/LEATHER



C OBUSFORME® COMFORT HIGH BACK HEAVY DUTY MULTI-TILTER CHAIRS

24 hour multi-tilter built for multi-shift use, seven days a week, three shifts a day, environment. Terrace fabric.

ERGONOMIC FEATURES:

A B C D E F G H M N Q R S

ORDER NUMBER	DESCRIPTION	UNIT
1 TS1240-3 TC74 BLK G3 HP	High back, fabric	EA
2 TS1240-3 BL20 BLK G3 HP	High back, bonded leather	EA

- A TENSION ADJUSTMENT
- B CHAIR TILT LOCK
- C SEAT HEIGHT
- D BACK/LUMBAR HEIGHT
- E SEAT DEPTH
- F SEAT ANGLE ADJUSTMENT

- G BACK ANGLE
- H ARM HEIGHT
- I ARM ANGLE
- J KNEE-TILT MOVEMENT
- L SYNCHRO-TILT MOVEMENT
- M WATERFALL SEAT EDGE

- N PROPERLY CONTOURED CUSHIONS
- P VIBRATING BACK / SEAT
- Q WIDTH ADJUSTABLE ARMS
- R ARM ROTATION
- S CENTRE-TILT MOVEMENT

- T PUSH BUTTON
- U SOFT DESCENT PNEUMATIC LIFT
- V LUMBAR DEPTH ADJUSTMENT

520 Call for more model & fabric selections. Freight charges may apply. Check online for the most current price.

SCHUKRA
Schukra lumbar support:

- Supports the pelvis and provides balance for the spinal column
- Supports vertebrae & lumbar region.
- Supports the upper body.



TERRACE FABRIC COLOURS

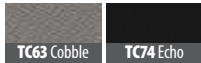

A GLOBAL™ GRANADA® SCHUKRA CHAIRS

Adjustable lumbar support for increased comfort levels. Pelvic, lumbar and upper body regions are supported and kept in balance by the Schukra® System. Infinite tilt-lock adjustments. Back height is adjustable with the Schukra handle on the chair back. Height and width adjustable arms, with seat slider. Terrace fabric.

ERGONOMIC FEATURES:

A B C D E G H M N Q S V

ORDER NUMBER	DESCRIPTION	UNIT
1 3117 3N TC74 BLK	High back, 43" H	EA
2 3112 3N TC74 BLK	Medium back, 37½" H	EA

Shown in
MS69 Black Mesh / Terrace fabric
TC74 Echo



TERRACE FABRIC COLOURS



B GLOBAL™ VION™ MULTI-TILTER CHAIR

Mesh multi-tilter chairs with Soft Descent™ pneumatic seat height adjustment and side activated sliding seat depth adjustment. Independent infinitely adjustable back angle; height and width adjustable arms. Optional adjustable lumbar support available. Terrace fabric.

ERGONOMIC FEATURES:

A B C G H M N Q S U

ORDER NUMBER	DESCRIPTION	UNIT
1 6321-3 TC74 MS69 BLK	High back	EA
2 6322-3 TC74 MS69 BLK	Medium back	EA

Supports users up to 350 lbs.

BONDED/LEATHER



C OFFICES TO GO™ HIGH BACK HEAVY DUTY OVERTIME MULTI-TILTER CHAIR

Heavy duty construction is rated for up to 350 pounds. Features standard seat depth adjustment with a generous size seat. Thick cushions with multiple density seat foam and a memory foam top. Ratchet back height adjustment. Height and width adjustable (G5) arms with sliding and lockable armcaps. The armcaps also articulate inwards and outwards 30° to aim toward the keyboard or mouse area.

ERGONOMIC FEATURES:

A B C D E F G H M N

ORDER NUMBER	UNIT
MVL13040 PU30/BL20 BLK	EA



NEW!

FUSION FABRIC COLOUR



D BASICS® CHEVRON ULTRA™ MULTI-TILTER CHAIRS

Features soft descent pneumatic seat height adjustment, seat depth adjustment, independent seat and back angle adjustment, infinitely adjustable seat angle, adjustable back angle, back height adjustment, tilt tension adjustment and articulating arm caps.

ERGONOMIC FEATURES:

A B C D E F G H M N Q R S U

ORDER NUMBER	DESCRIPTION	UNIT
1 1120-3 FU85 BLK G5 HP	High back, wide contoured seat	EA
2 1121-3 FU85 BLK G5 HP	Medium back, wide contoured seat	EA
3 1120P-3 FU85 BLK G5 HP	High back, petite seat	EA
4 1121P-3 FU85 BLK G5 HP	Medium back, petite seat	EA



Chairs – multi-tilter



Shown in Waterfall fabric WA50 Grand

Supports users up to 350 lbs.

WATERFALL FABRIC COLOURS

WA50 Grand	WA54 Dance
------------	------------



A OFFICES TO GO™ OVERTIME 350 MULTI-TILTER CHAIR

This high back chair is heavy duty having a 350 lb weight capacity. Features a breathable mesh back, seat depth adjustment, infinite position tilt-lock, back angle adjustment, adjustable lumbar support and height & width adjustable arms. Waterfall fabric.

ERGONOMIC FEATURES:

A B C D E F G H M N Q R S

ORDER NUMBER	DESCRIPTION	UNIT
MVL13090 WA54	High back	EA



Shown in Urban fabric UR22 Black Coal

URBAN FABRIC COLOUR

UR11 Ocean Blue	UR13 Green Grass	UR17 Earth	UR22 Black Coal
-----------------	------------------	------------	-----------------

BONDED/LEATHER

BL20 Black



B HIGH BACK GRANADA® DELUXE MULTI-TILTER CHAIR

Compound curve back with full ratchet back height adjustment; independent, infinite position back angle adjustment. Width and height adjustable arms. Tilt tension adjustment and infinite position tilt lock control. Seat depth adjustment; infinitely adjustable seat angle with forward and rearward incline. Urban fabric.

ERGONOMIC FEATURES:

A B C D E F G H M Q S U

ORDER NUMBER	DESCRIPTION	UNIT
1 1170-3 UR22 BLK 3B HP	Urban fabric	EA
2 1170-3 BL20 BLK 3B HP	Bonded leather	EA



Shown in Urban fabric UR22 Black Coal

URBAN FABRIC COLOUR

UR11 Ocean Blue	UR13 Green Grass	UR17 Earth	UR22 Black Coal
-----------------	------------------	------------	-----------------

C GRANADA® LOW BACK PNEUMATIC MULTI-TILTER CHAIR WITH SEAT SLIDER

Features a sculpted back with pronounced lumbar support. Standard height/width adjustable luxcurve arms may prevent repetitive strain injuries. Adjustable seat depth. Urban fabric.

ERGONOMIC FEATURES:

A B C D E F G H M N Q S

ORDER NUMBER	DESCRIPTION	UNIT
1 3212 3N UR22 BLK	Low back	EA
2 3217 3N UR22 BLK	High back	EA

- A TENSION ADJUSTMENT
- B CHAIR TILT LOCK
- C SEAT HEIGHT
- D BACK/LUMBAR HEIGHT
- E SEAT DEPTH
- F SEAT ANGLE ADJUSTMENT

- G BACK ANGLE
- H ARM HEIGHT
- I ARM ANGLE
- J KNEE-TILT MOVEMENT
- L SYNCHRO-TILT MOVEMENT
- M WATERFALL SEAT EDGE

- N PROPERLY CONTOURED CUSHIONS
- P VIBRATING BACK / SEAT
- Q WIDTH ADJUSTABLE ARMS
- R ARM ROTATION
- S CENTRE-TILT MOVEMENT

- T PUSH BUTTON
- U SOFT DESCENT PNEUMATIC LIFT
- V LUMBAR DEPTH ADJUSTMENT

522 Call for more model & fabric selections. Freight charges may apply. Check online for the most current price.

Chairs – multi-tilter

JENNY FABRIC COLOURS

BONDED/LEATHER

JN01 Midnite	JN02 Ebony	JN07 Vermillion	JN11 Charcoal	BL20 Black
--------------	------------	-----------------	---------------	------------



A OFFICES TO GO™ IBEX MEDIUM BACK MULTI-TILTER CHAIRS

Features adjustable lumbar support, pneumatic seat height, tilt tension control and height adjustable arms with self-skinned urethane armcaps. Upholstered model has Jenny fabric seat and front of back panel, black rear back panel. Available in models with all-mesh seat and back, mesh back and bonded leather seat and mesh back with fabric seat.

ERGONOMIC FEATURES:

A B C D E F G H M N S

ORDER NUMBER	DESCRIPTION	UNIT
1 MVL2813 JN02	Fully upholstered fabric	EA
2 MVL2803 BL20 BLK	Mesh back, bonded leather seat	EA
3 MVL2803 JN02 BLK	Mesh back, upholstered seat fabric	EA



TERRACE FABRIC COLOURS

TC64 Cherry Blossom	TC74 Echo
---------------------	-----------



B OFFICES TO GO™ AVRO MULTI-TILTER CHAIR

Features infinite position tilt lock and tilt tension adjustment, independent back and seat angle adjustment, forward seat angle adjustment, height and depth adjustable lumbar support, height adjustable arms. dual wheel carpet casters, pneumatic seat height adjustment and sliding seat depth adjustment.

ERGONOMIC FEATURES:

A B C D E F G H M N S V

ORDER NUMBER	DESCRIPTION	UNIT
MVL3103 TC74	Multi-tilter	EA



WATERFALL FABRIC COLOUR

WA54 Dance



C BASICS® ELORA™ MULTI-TILTER CHAIR

Features knitted mesh back, pneumatic seat height adjustment, seat depth adjustment, independent seat and back angle adjustment, infinitely adjustable seat angle, adjustable back angle, back height adjustment, tilt tension adjustment, and height and width adjustable arms.

ERGONOMIC FEATURES:

A B C D E F G H M N Q R S

ORDER NUMBER	DESCRIPTION	UNIT
MVL1893 WA54 G5 CX 19 QS	High back	EA



Call for more model & fabric selections. Freight charges may apply. Check online for the most current price. **523**

Chairs – multi-tilter



QUILT FABRIC COLOUR

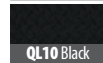

A OFFICES TO GO™ SIX 31 MULTI-TILTER CHAIR

A fully upholstered chair with infinite position tilt lock. Features multi-tilter mechanism with ratchet back height adjustment, seat slider seat depth adjustment and height adjustable arms. Ready to assemble. Quilt fabric.

ERGONOMIC FEATURES:

A B C D E F G H M N S

ORDER NUMBER	DESCRIPTION	UNIT
OTG11531B QL10 BLK	Medium back	EA



FUSION FABRIC COLOUR



B BASICS® PETITE-TIME MULTI-TILTER CHAIR

Ideal for smaller or slender individuals. The seat is 2" narrower and shallower than standard seats. Features pneumatic seat height adjustment, seat depth adjustment, independent seat and back angle adjustment, infinitely adjustable seat angle, adjustable back angle, back height adjustment, tilt tension adjustment and articulating armcaps. Fusion fabric.

ERGONOMIC FEATURES:

A B C D E F G H M N Q R S

ORDER NUMBER	DESCRIPTION	UNIT
MVL1880 FU85 BLK G5 HP	High back, petite seat	EA



FUSION FABRIC COLOUR



C BASICS® COMFORT-TIME ULTRA MULTI-TILTER CHAIR

Features pneumatic seat height adjustment, seat depth adjustment, independent seat and back angle adjustment, infinitely adjustable seat angle, adjustable back angle, back height adjustment, tilt tension adjustment, and articulating armcaps. Fusion fabric.

ERGONOMIC FEATURES:

A B C D E F G H M N Q R S

ORDER NUMBER	DESCRIPTION	UNIT
MVL1873 FU85 BLK G5 HP	High back	EA

- A TENSION ADJUSTMENT
- B CHAIR TILT LOCK
- C SEAT HEIGHT
- D BACK/LUMBAR HEIGHT
- E SEAT DEPTH
- F SEAT ANGLE ADJUSTMENT

- G BACK ANGLE
- H ARM HEIGHT
- I ARM ANGLE
- J KNEE-TILT MOVEMENT
- L SYNCHRO-TILT MOVEMENT
- M WATERFALL SEAT EDGE

- N PROPERLY CONTOURED CUSHIONS
- P VIBRATING BACK / SEAT
- Q WIDTH ADJUSTABLE ARMS
- R ARM ROTATION
- S CENTRE-TILT MOVEMENT

- T PUSH BUTTON
- U SOFT DESCENT PNEUMATIC LIFT
- V LUMBAR DEPTH ADJUSTMENT

Chairs – multi-tilter



A OFFICES TO GO™ REGALIA MESH BACK MULTI-TILTER CHAIR

Air mesh fabric seat and mesh back. Height adjustable “T” style arms with self-skinned urethane armcaps. Pneumatic seat height adjustment; back height adjustment; independent and infinite position back angle adjustment. Infinite position tilt-lock and tilt tension control. Seat depth adjustment with seat slider. Black.

ERGONOMIC FEATURES:

A B C D E G H M N S

ORDER NUMBER	DESCRIPTION	UNIT
1 OTG10895	High back	EA
2 OTG10892	Medium back	EA



Shown in
Bonded leather
BL20 Black



BONDED/LEATHER

PU30/BL20 Black

QUILT FABRIC COLOURS

QL10 Black

QL11 Charcoal grey

QL14 Navy

QL16 Wine

B OFFICES TO GO™ OVERTIME HIGH BACK MULTI-TILTER CHAIR

Long-term comfort seat with memory foam on top. Multi-tilter mechanism, infinite position tilt lock and tilt tension adjustments; independent back and forward seat angle adjustments. Pneumatic seat height and ratchet back height adjustments. Height and width adjustable arms; dual wheel carpet casters.

ERGONOMIC FEATURES:

A B C D G H M N Q S

ORDER NUMBER	DESCRIPTION	UNIT
1 MVL2756 PU30/BL20 BLK	Bonded leather, Black	EA
2 MVL2756 QL10	Quilt fabric	EA



Shown in
Quilt fabric
QL10 Black

QUILT FABRIC COLOURS

QL10 Black

QL11 Charcoal grey

QL14 Navy

QL16 Wine



C OFFICES TO GO™ FULL-TIME MEDIUM BACK MULTI-TILTER CHAIR

With comfortable, extra thick back and seat cushions. Infinite angle forward tilt; back height adjustment. Height and width adjustable arms with self-skinned urethane armcaps. Quilt fabric.

ERGONOMIC FEATURES:

A B C D F G H M N Q S

ORDER NUMBER	DESCRIPTION	UNIT
MVL2900 QL10 BLK	Medium back	EA

Chairs – synchro-tilter



Shown in Terrace fabric TC74 Echo



TERRACE FABRIC COLOURS

TC67 Haze	TC71 Ironworks	TC74 Echo
-----------	----------------	-----------

Supports users between 225 and 400 lbs.

A GLOBAL® OBUSFORME COMFORT XL™ CHAIRS

Designed to accommodate the big and tall user. The high quality Soft Descent™ pneumatic lift will support users from 225 to 400 pounds. Allows you to adjust the space between the arms from 22" to 26" apart. Tall users will benefit from the added seat depth (an extra 1.5" deeper than standard), the 2.5" seat slider adjustment and the extra tall 53" ratchet style back with no pressure points along the spine. The torque requirement automatically changes for each user, without the need for any manual adjustment.

HIGH BACK, WIDE & DEEP WEIGHT SENSING SYNCHRO-TILT

ERGONOMIC FEATURES:

A B C D E H L M N Q R U

ORDER NUMBER	DESCRIPTION	UNIT
1 1252-8 TC74 BLK G3 HP	High back wide and deep	EA

MEDIUM BACK, WIDE STANDARD DEPTH SYNCHRO-TILT

ERGONOMIC FEATURES:

A B C D E G H L M N Q R U

ORDER NUMBER	DESCRIPTION	UNIT
2 1256-0 TC74 BLK G3 HP	Medium back standard	EA



TERRACE FABRIC COLOURS

TC64 Cherry Blossom	TC74 Echo
---------------------	-----------

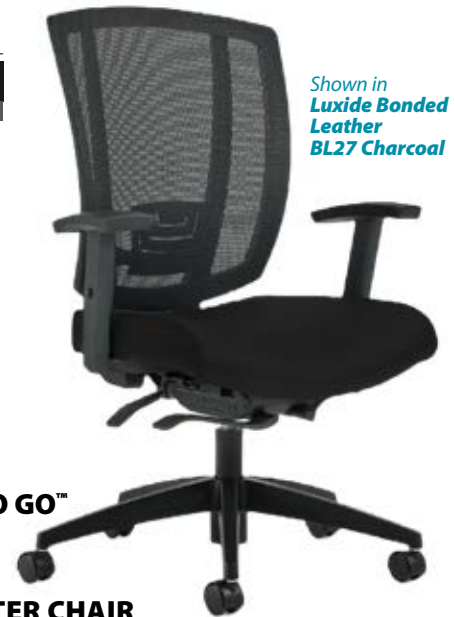

Shown in Luxide Bonded Leather BL27 Charcoal

B GLOBAL™ LOOVER™ SYNCHRO TILT CHAIRS

URBAN FABRIC / VUE MESH COLOURS

UR10 / VU18 Red Rose	UR22 / VU19 Black Coal
----------------------	------------------------

Features a weight sensing synchro-tilter mechanism requiring no tilt tension adjustments – always set right for everyone's body weight. Height adjustable back with concealed ratchet system offering a 2.25" height adjustment. Standard side-activated sliding seat depth adjustment up to 2"; Soft Descent™ pneumatic lift slowly and gently lowers the seat height of the chair. Height, depth and width adjustable armcaps articulate inward and outward 30° toward keyboard or mouse.

ERGONOMIC FEATURES:

A B C D E H L M N Q R

ORDER NUMBER	DESCRIPTION	UNIT
1 2660-8 G5 UR22 VU19	Extended high back	EA
2 2661-8 G5 UR22 VU19	High back	EA

C OFFICES TO GO™ AVRO WEIGHT SENSING SYNCHRO TILT CHAIR

Air-flow mesh back. Multi position tilt-lock.

Weight sensing synchro-tilter automatically adjusts the reclining tilt-tension for each user's individual weight. Adjustable lumbar support – height and depth. Height adjustable arms with urethane armcaps. Dual wheel carpet casters. Pneumatic seat height adjustment. Side activated sliding seat depth adjustment. Terrace fabric.

ERGONOMIC FEATURES:

A B C D E H L M N V

ORDER NUMBER	DESCRIPTION	UNIT
MVL3108 TC74	Weight sensing	EA

- A TENSION ADJUSTMENT
- B CHAIR TILT LOCK
- C SEAT HEIGHT
- D BACK/LUMBAR HEIGHT
- E SEAT DEPTH
- F SEAT ANGLE ADJUSTMENT

- G BACK ANGLE
- H ARM HEIGHT
- I ARM ANGLE
- J KNEE-TILT MOVEMENT
- L SYNCHRO-TILT MOVEMENT
- M WATERFALL SEAT EDGE

- N PROPERLY CONTOURED CUSHIONS
- P VIBRATING BACK / SEAT
- Q WIDTH ADJUSTABLE ARMS
- R ARM ROTATION
- S CENTRE-TILT MOVEMENT

- T PUSH BUTTON
- U SOFT DESCENT PNEUMATIC LIFT
- V LUMBAR DEPTH ADJUSTMENT

526 Call for more model & fabric selections. Freight charges may apply. Check online for the most current price.

Chairs – synchro-tilter



QUILT FABRIC COLOUR



QL10 Black

A OFFICES TO GO™ TOMA SYNCHRO-TILTER CHAIR

Medium back chair with upright position tilt lock and tilt tension adjustment. Height adjustable flexible lumbar support and arms. Black fabric.

ERGONOMIC FEATURES:



ORDER NUMBER	UNIT
OTG13032 BLK	EA

NEW!



TERRACE FABRIC COLOUR



TC74 Echo

B OFFICES TO GO™ FORMAT SYNCHRO TILTER CHAIRS

Upright tilt lock. Ratchet back height adjustment. Height and width adjustable arms. Terrace fabric.

ERGONOMIC FEATURES:



ORDER NUMBER	DESCRIPTION	UNIT
1 MVL3191 TC74	High back	EA
2 MVL3192 TC74	High back with head rest	EA

Seat shown in
Quilt fabric
QL10 Black



QUILT FABRIC COLOURS

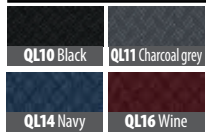

QL10 Black QL11 Charcoal grey

QL14 Navy QL16 Wine

C OFFICES TO GO™ PACER SYNCHRO TILTER CHAIR

Low back multi-position synchro tilter chair with mesh back and upholstered seat. Features unique back shroud design, pneumatic seat height adjustment, multi-position tilt lock, tilt tension adjustment. Height adjustable "T"-style arms with polyurethane armcaps. Quilt fabric.

ERGONOMIC FEATURES:



ORDER NUMBER	UNIT
OTG11686 QL10	EA



D OFFICES TO GO™ ZIM SYNCHRO-TILTER CHAIR

Unique high back frame designed with wrap around mesh back. Pneumatic seat height adjustment. Seat depth adjustment. Tilt tension adjustment. Height adjustable arms.

ERGONOMIC FEATURES:



ORDER NUMBER	DESCRIPTION	UNIT
1 OTG11351B	Black mesh, Black seat	EA
2 OTG11351G	Grey mesh, Black seat	EA

Call for more model & fabric selections. Freight charges may apply. Check online for the most current price. **527**

Chairs – tilter

Seat shown in
**Jenny fabric
JN02 Ebony**



JENNY FABRIC COLOURS



A GLOBAL ACCORD™ MESH BACK TILTER CHAIRS

Elegant and refined seating features a polished aluminum arm with a sling style back, upholstered with rolled and pleated details. Adjustments: tension, seat height, center-tilt. Chair tilt lock, contoured cushions, waterfall seat edge. Jenny fabric.

ERGONOMIC FEATURES:

A B C M N S U

ORDER NUMBER	DESCRIPTION	UNIT
1 2677-4 JN02 VU19 ALU	Medium back, 25" W×25" D×44" H	EA
2 2676-4 JN02 VU19 ALU	High back, 25" W×25" D×37" H	EA

Shown in
**Allante Free vinyl
A16F Ink**



Shown in
**Allante Free vinyl
A12F Gibraltar**



B GLOBAL ACCORD™ TILTER CHAIRS

Elegant and refined seating features a polished aluminum arm with a sling style back, upholstered with rolled and pleated details. Adjustments: tension, seat height, center-tilt. Chair tilt lock, contoured cushions, waterfall seat edge. Allante vinyl.

ALLANTE FREE VINYL COLOURS

ERGONOMIC FEATURES:

A B C M N S U



ORDER NUMBER	DESCRIPTION	UNIT
1 2670-4 A16F ALU	High back, 25" W×25" D×44" H	EA
2 2671-4 A16F ALU	Medium back, 25" W×25" D×37" H	EA



BONDED/LEATHER

PU30/BL20 Black



C OFFICES TO GO™ BRIGHTON HIGH BACK TILTER CHAIR

Features loop arms with upholstered arm caps, an integrated headrest, contoured seat and back, tilt tension control, upright tilt lock and a black finish on the arms and base. Black bonded leather.

ERGONOMIC FEATURES:

A B C M N S

ORDER NUMBER	UNIT
MVL2787 PU30 BL20	EA

- A** TENSION ADJUSTMENT
- B** CHAIR TILT LOCK
- C** SEAT HEIGHT
- D** BACK/LUMBAR HEIGHT
- E** SEAT DEPTH
- F** SEAT ANGLE ADJUSTMENT

- G** BACK ANGLE
- H** ARM HEIGHT
- I** ARM ANGLE
- J** KNEE-TILT MOVEMENT
- L** SYNCHRO-TILT MOVEMENT
- M** WATERFALL SEAT EDGE

- N** PROPERLY CONTOURED CUSHIONS
- P** VIBRATING BACK / SEAT
- Q** WIDTH ADJUSTABLE ARMS
- R** ARM ROTATION
- S** CENTRE-TILT MOVEMENT

- T** PUSH BUTTON
- U** SOFT DESCENT PNEUMATIC LIFT
- V** LUMBAR DEPTH ADJUSTMENT

528 Call for more model & fabric selections. Freight charges may apply. Check online for the most current price.



A OFFICES TO GO™ KAZAN HIGH BACK TILTER CHAIR

Wing back, with single position tilt lock, tilt tension control. Polyurethane vinyl back and seat with decorative stitching; wrapped loop arms. Bonded leather, Black.

ERGONOMIC FEATURES:

A B C M N S

BONDED/LEATHER



ORDER NUMBER	UNIT
OTG11670B BLK	EA



B OFFICES TO GO™ ASHMONT TILTER CHAIRS

The Ashmont medium and high back tilters have deep, soft cushions. The arms are height adjustable with self-skinned urethane caps. It has tilt tension control and upright tilt lock. Black bonded leather.

ERGONOMIC FEATURES:

A B C H M N S

BONDED/LEATHER



ORDER NUMBER	DESCRIPTION	UNIT
1 MVL2780 PU30 BL20 BLK	High back	EA
2 MVL2781 PU30 BL20 BLK	Medium back	EA



Shown in Terrace fabric TC74 Echo

TERRACE FABRIC COLOUR



C GLOBAL™ SUPRA™ SERIES TILTER CHAIRS

Contoured cushions support the user in comfortable, contemporary style. Features tilt tension control, upright position tilt lock and moulded polyurethane waterfall armrests. Tungsten arms and black base. Specify colour.

ERGONOMIC FEATURES:

A B C M N S

ORDER NUMBER	DESCRIPTION	UNIT
1 5330-4 TC74 TUB HP	High back	EA
2 5331-4 TC74 TUB HP	Mid back	EA



BONDED/LEATHER

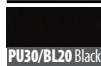

D OFFICES TO GO™ ULTRA TILTER

Tilter with chrome base and fixed arms. Luxhide bonded leather. Black.

ERGONOMIC FEATURES:

A B C M N S

ORDER NUMBER	DESCRIPTION	UNIT
1 MVL11730 PU30 BL20 CHM	High back NEW!	EA
2 MVL11734 PU30 BL20 CHM	Low back	EA

Chairs – tilter

A OFFICES TO GO™ CARLETON MANAGEMENT TILTER CHAIR

A traditional look with a bit of modern ergonomics. Features a high back, contoured seat, seat depth adjustment, waterfall seat edge, tilt lock, adjustable lumbar support, tilt tension adjustment and height adjustable arms. Textured Fabric. Graphite.

ERGONOMIC FEATURES:
A B C H M N S



ORDER NUMBER	UNIT
OTG11358	EA

B OFFICES TO GO™ SIX 31 MEDIUM BACK OPERATOR CHAIR

Pneumatic seat height adjustment, seat depth adjustment. Height adjustable T-style arms with self-skinned urethane armcaps. Other adjustments: back angle, seat angle, tilt-tension. Quilt Black fabric.

ERGONOMIC FEATURES:
A B C D G H M N S



Shown in Quilt fabric QL10 Black

ORDER NUMBER	UNIT
OTG11631B QL10 BLK	EA



C OFFICES TO GO™ ZUNE MEDIUM BACK TILTER CHAIRS

Plastic back shroud showing slat detail. Generous proportions; deep padded upholstered seat cushion, upholstered armcaps. Upright tilt lock; tilt tension adjustment. Black.

ERGONOMIC FEATURES:
A B C M N S

ORDER NUMBER	DESCRIPTION	UNIT
1 OTG11751B	Knitted mesh back	EA
2 OTG11975B	Upholstered back	EA

BONDED/LEATHER

PUBO/BL20 Black

D OFFICES TO GO™ KAYSEE HIGH BACK TILTER CHAIR

Pneumatic seat height adjustment. Single position tilt lock. Adjustable lumbar support. Tilt tension adjustment. Height adjustable arms with urethane armcaps. Mesh back and bonded leather seat. Upholstered in black Luxhide bonded leather.

ERGONOMIC FEATURES:
A B C D H L M N

ORDER NUMBER	UNIT
OTG12112B	EA



- A TENSION ADJUSTMENT
- B CHAIR TILT LOCK
- C SEAT HEIGHT
- D BACK/LUMBAR HEIGHT
- E SEAT DEPTH
- F SEAT ANGLE ADJUSTMENT

- G BACK ANGLE
- H ARM HEIGHT
- I ARM ANGLE
- J KNEE-TILT MOVEMENT
- L SYNCHRO-TILT MOVEMENT
- M WATERFALL SEAT EDGE

- N PROPERLY CONTOURED CUSHIONS
- P VIBRATING BACK / SEAT
- Q WIDTH ADJUSTABLE ARMS
- R ARM ROTATION
- S CENTRE-TILT MOVEMENT

- T PUSH BUTTON
- U SOFT DESCENT PNEUMATIC LIFT
- V LUMBAR DEPTH ADJUSTMENT

530 Call for more model & fabric selections. Freight charges may apply. Check online for the most current price.

Chairs – tilter



BONDED/LEATHER

PU30/BL20 Black



A OFFICES TO GO™ COBALT MEDIUM BACK TILTER CHAIR

This medium back tilter has an upright position tilt lock, tilt tension adjustment and height adjustable arms with durable self-skinned urethane arm caps. Black bonded leather.

ERGONOMIC FEATURES:

A B C H M N S

ORDER NUMBER	UNIT
MVL2785 PU30 BL20 BLK	EA

Seat shown in
Waterfall fabric
WA54 Dance



B OFFICES TO GO™ SAFARI TILTER CHAIR

This medium back black mesh chair features a tilter mechanism with upright tilt lock. The compact design is suitable for average to petite sized individuals. Waterfall fabric.

ERGONOMIC FEATURES:

A B C M N S

WATERFALL FABRIC COLOURS

WA50 Grand	WA53 Pacific	WA54 Dance
------------	--------------	------------

ORDER NUMBER	UNIT
OTG13026 WA54 BLK	EA



C OFFICES TO GO™ AMIRA TILTER CHAIR

Medium back black mesh chair with soft sculpted lines and fixed loop arms. Tilter mechanism with upright tilt lock and a black fabric seat.

ERGONOMIC FEATURES:

A B C M N S

ORDER NUMBER	UNIT
OTG13020 BLK	EA

NEW!



D BASICS® TRENT™ TILTER CHAIR

Features pneumatic seat height adjustment, upright position tilt lock, tilt tension adjustment and fixed loop arms. Black bonded leather.

ERGONOMIC FEATURES:

A B C M N S



ORDER NUMBER	DESCRIPTION	UNIT
2717-4 PU30 BL20 BLK	High back	EA

Call for more model & fabric selections. Freight charges may apply. Check online for the most current price. **531**

Chairs – tilter



KNITTED MESH



A OFFICES TO GO™ GEO TILTER CHAIR

Tilter mechanism with tilt tension adjustment; upright position tilt lock; pneumatic seat height adjustment. Loop style polypropylene arms; dual wheel carpet casters. Dimensions: 22" W×21" D×38" H. Black knitted mesh.

ERGONOMIC FEATURES:

A B C M N S

ORDER NUMBER	UNIT
OTG11636B BLK	EA



B OFFICES TO GO™ JAVA MEDIUM BACK TILTER CHAIR

Features tilter mechanism with tilt tension adjustment and upright tilt lock. Fully upholstered black air mesh fabric seat; grey mesh back with geometric shroud. Fixed plastic loop arms; black frame, black spider base.

ERGONOMIC FEATURES:

A B C M N S

ORDER NUMBER	UNIT
OTG10902	EA



C OFFICES TO GO™ AMIGO LOW BACK TILTER CHAIR

Amigo offers a tilter mechanism with tilt tension adjustment and upright tilt lock, fixed plastic arms, black mesh back and black spider base. Seat upholstered in black air mesh fabric.

ERGONOMIC FEATURES:

A B C M N S

ORDER NUMBER	UNIT
OTG10900 BLK	EA

- A TENSION ADJUSTMENT
- B CHAIR TILT LOCK
- C SEAT HEIGHT
- D BACK/LUMBAR HEIGHT
- E SEAT DEPTH
- F SEAT ANGLE ADJUSTMENT

- G BACK ANGLE
- H ARM HEIGHT
- I ARM ANGLE
- J KNEE-TILT MOVEMENT
- L SYNCHRO-TILT MOVEMENT
- M WATERFALL SEAT EDGE

- N PROPERLY CONTOURED CUSHIONS
- P VIBRATING BACK / SEAT
- Q WIDTH ADJUSTABLE ARMS
- R ARM ROTATION
- S CENTRE-TILT MOVEMENT

- T PUSH BUTTON
- U SOFT DESCENT PNEUMATIC LIFT
- V LUMBAR DEPTH ADJUSTMENT

532 Call for more model & fabric selections. Freight charges may apply. Check online for the most current price.



BONDED/LEATHER

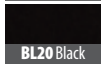

A OFFICES TO GO™ IBEX TASK CHAIR

Features air-flow mesh back, lumbar support with height adjustment, seat depth adjustment, height adjustable SSU (self-skinned urethane) capped arms, dual wheel carpet casters and pneumatic seat height adjustment. Upholstered in Luxhide bonded leather. Luxhide bonded leather.

ERGONOMIC FEATURES:



ORDER NUMBER	UNIT
MVL2806 BL20	EA



WATERFALL FABRIC COLOURS



B OFFICES TO GO™ YOHO TASK CHAIR

Medium back. Pneumatic seat height adjustment. Deep contoured cushions. Swivel task mechanism. Compound curve back support. Height adjustable arms with soft urethane armcaps. Dual wheel carpet casters. Waterfall fabric.

ERGONOMIC FEATURES:



ORDER NUMBER	DESCRIPTION	UNIT
1 MVL2778 WA54	With Arms	EA
2 MVL2779 WA54	Armless	EA



Shown in Quilt fabric QL10 Black



ERGONOMIC FEATURES:



ERGONOMIC FEATURES:



C OFFICES TO GO™ TAMI TASK CHAIRS

Hinged back, scuff resistant outer shroud, dual wheel carpet casters. Pneumatic seat height adjustment, seat depth adjustment. Quilt fabric.

QUILT FABRIC COLOURS

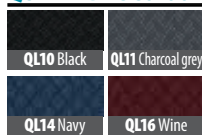

ORDER NUMBER	DESCRIPTION	UNIT
1 MVL1616 QL10 BLK	Armless	EA
2 MVL1617 QL10 BLK	With arms	EA



Shown in Quilt fabric QL10 Black



ERGONOMIC FEATURES:



ERGONOMIC FEATURES:



D OFFICES TO GO™ DANIO TASK CHAIRS

With bigger seat and back, thicker foam and decorative stitch details. Hinged auto-adjust, height adjustable back. Pneumatic seat height adjustment, seat depth adjustment. Quilt fabric, specify colour.

QUILT FABRIC COLOURS

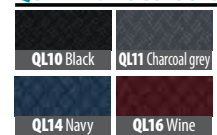

ORDER NUMBER	DESCRIPTION	UNIT
1 MVL2720 QL10 BLK	Armless	EA
2 MVL2721 QL10 BLK	With arms	EA

Chairs – guest



Shown in Carrera fabric CE86 Slate

CARRERA FABRIC COLOURS



A GLOBAL™ SOLO® ARMCHAIR

Features durable steel round tube frame, contoured back and seat with waterfall seat edge and self-skinned urethane armcaps. Carrera fabric.

ERGONOMIC FEATURES: **M N**

ORDER NUMBER	UNIT
5225 CE95 BLK	EA



BONDED LEATHER



B OFFICES TO GO™ ASHMONT GUEST CHAIR

Features deep and soft cushions, upholstered arm caps and an oval steel sled base. Black bonded leather.

ERGONOMIC FEATURES: **M N**

ORDER NUMBER	UNIT
MVL2782 PU30 BL20 BLK	EA



BONDED/LEATHER



C OFFICES TO GO™ CENTRO GUEST CHAIR

Features oval tube epoxy coated frame and upholstered armcaps. Luxhide Black bonded leather.

ERGONOMIC FEATURES: **M N**

ORDER NUMBER	UNIT
OTG3915 PU30 BL20 BLK	EA



D OFFICES TO GO™ REGALIA GUEST CHAIR

Upholstered armcaps. Lumbar adjustment. Mesh back with air-mesh upholstered seat.

ERGONOMIC FEATURES: **M N**

ORDER NUMBER	UNIT
OTG10893 BLK	EA



D OFFICES TO GO™ DASH GUEST CHAIR

Features a welded steel frame with durable nylon armcaps. Generously proportioned air flow mesh back and air-mesh fabric upholstered seat. Black.

ERGONOMIC FEATURES: **M N**

ORDER NUMBER	UNIT
OTG11760B	EA

C SEAT HEIGHT
D BACK/LUMBAR HEIGHT

E SEAT DEPTH
H ARM HEIGHT

M WATERFALL SEAT EDGE

N PROPERLY CONTOURED CUSHIONS

534 Call for more model & fabric selections. Freight charges may apply. Check online for the most current price.



Shown in
Jenny fabric
JN02 Ebony



Shown in
Terrace fabric
TC74 Echo



JENNY FABRIC COLOURS

JN01 Midnite	JN02 Ebony	JN07 Vermillion	JN11 Charcoal
--------------	------------	-----------------	---------------

TERRACE FABRIC COLOURS

TC67 Haze	TC71 Ironworks	TC74 Echo
-----------	----------------	-----------

A OFFICES TO GO™ MINTO STACKING CHAIRS

Round tube steel frame; upholstered seat and back. Model 2747 has polypropylene armcaps. Stacks up to five high on floor. Jenny fabric.

ERGONOMIC FEATURES: **M N**

ORDER NUMBER	DESCRIPTION	UNIT
1 MVL2747 JN02 BLK	Armchair	EA
2 MVL2748 JN02 BLK	Armless chair	EA

B GLOBAL™ SUPRA™ ARMCHAIR

Contoured cushions support the user in comfortable, contemporary style. Features molded polyurethane waterfall armrests. Hudson fabric. Specify colour.

ERGONOMIC FEATURES: **M N**

ORDER NUMBER	UNIT
5332 TC74 TUN	EA

C OFFICES TO GO™ FOLDING CHAIR

Lightweight, durable, easy to clean. Powder coated steel frame. Plastic seat and back.

ORDER NUMBER	UNIT
OTG11674	EA



D OFFICES TO GO™ IBEX GUEST CHAIR

Black welded wall saver frame. Versatile – for guest, reception and occasional seating applications. Stackable.

ERGONOMIC FEATURES: **M N**

ORDER NUMBER	DESCRIPTION	UNIT
1 MVL2819 BL20 BLK	Black bonded leather.	EA
2 MVL2809	Mesh back and black fabric seat	EA



D OFFICES TO GO™ EOR GUEST CHAIRS

Contoured back and seat cushions with waterfall seat edge; upholstered soft self-skinned polyurethane armcaps; seat shroud provides a clean overall finish; upholstered in black Luxhide bonded leather.

ERGONOMIC FEATURES: **M N**

ORDER NUMBER	DESCRIPTION	UNIT
1 OTG3920B	Upholstered back and seat	EA
2 OTG3930B	Mesh back and upholstered seat	EA

Chairs – stacking

Shown in
SHW Shadow



Shown in
SAR Scarlet

Shown in
IVC Cloud

SONIC/ DUET PLASTIC COLOURS

BLK Night
BZB Buzz Blue
IVC Cloud
LAB Latte
SAR Scarlet
SHW Shadow

Shown in
BZB Buzz Blue



Shown in
BLK Night

Shown in
LAB Latte



A GLOBAL™ SONIC™ STACKING CHAIRS

Designed to co-ordinate with the Sonic Beam set. Practical, easy-clean plastic construction over a metal frame.

ORDER NUMBER	DESCRIPTION	UNIT
6508 ___ CM	Specify colour	EA



B GLOBAL™ DUET™ ARMLESS CHAIR

Steel rod chrome frame with sled base; polypropylene seat and backs.

ORDER NUMBER	DESCRIPTION	UNIT
6621 ___ CM	Specify colour	EA



C OFFICES TO GO™ GENNEX NESTING CHAIR WITH CASTERS

Features a flip-up seat allowing chairs to stack horizontally. Black mesh back with an upholstered seat and dual wheel carpet casters.

ERGONOMIC FEATURES: **M** **N**

ORDER NUMBER	DESCRIPTION	UNIT
1 OTG11340 WA45	Armchair	EA
2 OTG11341 WA45	Armless	EA



D OFFICES TO GO™ DORI 2 STACKING CHAIRS

Chromed steel frame; black polypropylene seat and back. Stacks up to five high. Available in armchair and armless versions.

ORDER NUMBER	DESCRIPTION	UNIT
1 OTG1220B	Armchair, Black	EA
2 OTG1221B	Armless sidechair, Black	EA

C SEAT HEIGHT

H ARM HEIGHT

M WATERFALL SEAT EDGE

N PROPERLY CONTOURED CUSHIONS

536 Call for more model & fabric selections. Freight charges may apply. Check online for the most current price.



**A OFFICES TO GO™
IBEX DRAFTING TASK CHAIR**

Features dual wheel carpet casters, height adjustable chromed foot rest, pneumatic seat height adjustment and height adjustable 'T' arms. Mesh back and Luxhide bonded leather seat. Black.

ERGONOMIC FEATURES: **C H M N**

ORDER NUMBER	UNIT
MVL2808 BL20 BLK	EA



FUSION FABRIC COLOUR



**B BASICS®
COMFORT-TIME™ DRAFTING CHAIR**

Features pneumatic seat height adjustment and adjustable foot ring, adjustment and adjustable foot ring.

ERGONOMIC FEATURES: **C E M N**

ORDER NUMBER	DESCRIPTION	UNIT
1 MVL2878 FU85 BLK SC HP	Low back with arms	EA
2 MVL2868 FU85 BLK	Low back without arms	EA

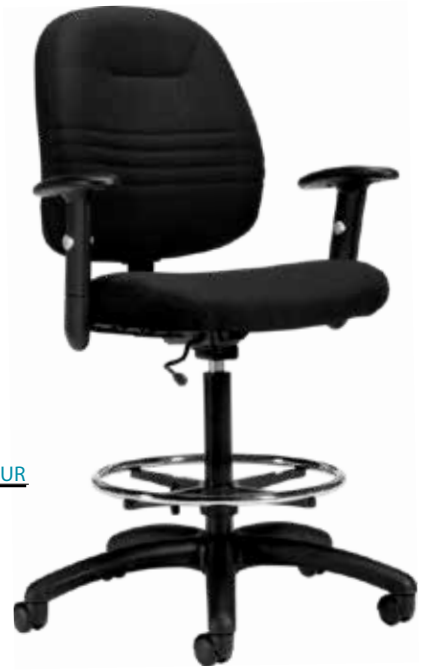

FUSION FABRIC COLOUR



**C BASICS® CHEVRON
JR. DRAFTING AND
TASK CHAIR**

The drafting chair features adjustable seat depth and pneumatic seat height adjustment. The task chair features infinite back angle and back height adjustment as well as pneumatic seat height adjustment. Optional height adjustable arms #MVL2365-3N available.

ERGONOMIC FEATURES: **C E M N**

ORDER NUMBER	DESCRIPTION	UNIT
1 MVL2362-6 FU85 BLK HP ST	Armless drafting chair	EA
2 MVL2363-7 FU85 BLK HP ST	Armless low back posture task chair	EA





70 Black

A OFFICES TO GO™ FILE BUDDY PNEUMATIC SWIVEL STOOLS

The comfortable solution for filing and other tasks. Two sizes available with pneumatic seat height adjustment, 5" or 10" range. Black vinyl.

ERGONOMIC FEATURES: **C**

ORDER NUMBER	DESCRIPTION	UNIT
1 MVL1105 70 BLK	16½"- 21½"	EA
2 MVL1110 70 BLK	22½"- 32½"	EA



B GLOBAL™ MINOTAUR™ LOW BACK TASK CHAIR

Contoured polyurethane seat and back; articulating, hinged back. Pneumatic seat height adjustment (10" range); seat depth adjustment. Hard floor casters. Black.

ERGONOMIC FEATURES: **C D F G**

ORDER NUMBER	UNIT
9663-64 BLK	EA



ALLANTE FREE FR VINYL

A16F Ink



D GLOBAL™ HEAVY DUTY BENCH STOOL

With upholstered seat pan, chromed frame and foot ring and heavy duty non-slip rubber glides. 32½" High. Allante vinyl, Black.

ORDER NUMBER	UNIT
9632-50 A16F CHM	EA



Shown in **Urban fabric UR21 Gravel Road**

URBAN FABRIC COLOURS

UR21 Gravel Road UR22 Black Coal



C GLOBAL™ SIDERO™ COUNTER & BAR HEIGHT STOOLS AND ARMCHAIR

Wall saver leg design hits the baseboard first, leaving clearance between the back of the chair and the wall, saving both from damage. Compound curved back provides comfort and support. Urban fabric.

ERGONOMIC FEATURES: **M N**

ORDER NUMBER	DESCRIPTION	UNIT
1 6900 UR22 BK BG	Armchair	EA
2 6904 UR22 BK BG	Counter height, 24½" seat height	EA
3 6906 UR22 BK BG	Bar height, 28½" seat height	EA



E GLOBAL™ DUAL WHEEL CASTERS

ORDER NUMBER	DESCRIPTION	UNIT
FOR CARPETS		
1 C1SET	2" Universal	5/ST
2 C65SET	2" Integrated	5/ST
FOR HARD FLOORS		
3 C9RSET	2½" Universal	5/ST
4 C65RSET	2" Integrated with standard collar	5/ST
5 C10RSET	2" Integrated with large collar	5/ST

C SEAT HEIGHT
D BACK/LUMBAR HEIGHT

F SEAT ANGLE ADJUSTMENT
G BACK ANGLE

M WATERFALL SEAT EDGE

N PROPERLY CONTOURED CUSHIONS

538 Call for more model & fabric selections. Freight charges may apply. Check online for the most current price.



GLOBAL™ BEAM SEATING

A truly flexible solution for waiting rooms and reception. Seating units easily attach to a universal beam base. Available in two, three and four person lengths, beam units can be positioned tightly along a wall in a straight run or expanded for L or U configurations.

A POPCORN SEAT

ORDER NUMBER	DESCRIPTION	UNIT
6719	Armless, upholstered seat, plastic back	EA

B DUET SEAT

ORDER NUMBER	DESCRIPTION	UNIT
1 6697	Upper with arms, upholstered seat & back	EA
2 6691	Armless upper poly seat & back	EA

C SONIC SEAT

ORDER NUMBER	DESCRIPTION	UNIT
1 6506GLX	Top with arms, upholstered seat & back	EA
2 6502	Armless, upholstered seat, plastic back	EA
3 6501	Armless, plastic seat & back	EA

D UNIVERSAL BEAM COMPONENTS

ORDER NUMBER	DESCRIPTION	UNIT
1 6500S2	2 seater beam	EA
2 6500S3	3 seater beam	EA
3 6500S4	4 seater beam	EA
4 6507-CT	Coffee table	EA
5 6507-T2	Radius corner table top	EA
6 6507	Table top	EA
7 6500A9	90° beam corner joiner bar	EA
8 6500A8	Universal aluminum arm	EA

craft

re-imagine. reconfigure. repeat.

From open reception areas to collaborative hubs, our modular soft seating solutions are flexible and can be re-purposed to suit the ever-changing needs of your workplace. The Craft™ collection features a durable design and includes a variety of geometric shapes allowing you to create infinite layout possibilities.

craft collection

Product available in vinyl and bonded leather for better cleaning and infection control.



MVL13007
round

UNIT
EA



MVL13008
half round

UNIT
EA



MVL13009
wedge

UNIT
EA



MVL13010
curve-120 degree

UNIT
EA



MVL13011
rectangle

UNIT
EA



MVL13012
square

UNIT
EA



MVL13021
rectangle overtable

UNIT
EA



MVL13022
wedge overtable

UNIT
EA



ML35SCDK
square cube docking table

UNIT
EA



ML2420CDKP
single docking table

UNIT
EA

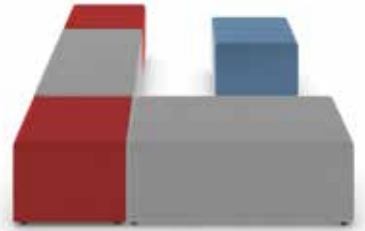

Chairs – reception



A GLOBAL™ CITI™ RECEPTION SEATING

Offers a contemporary, timeless, finely scaled look which works particularly well where space is limited. Raised legs enhance the lightness of scale and provide easy access for cleaners. Cushions sewn with double needle-stitched seams, appropriate for reception areas. Alternate lounge chair model available with right tablet laminate work surface. California black. Coffee table not available.

ORDER NUMBER	DESCRIPTION	UNIT
1 7875 CF83 R1	Lounge chair	EA
2 7875RTL CF83 BLK R1	Lounge chair with right tablet arm	EA
3 7876 CF83 R1	Two-seat sofa	EA
4 7877 CF83 R1	Three-seat sofa	EA



B OFFICES TO GO™ SUBURB SERIES

Features removable and reversible cushions, slant forward arms and generous proportions. Upholstered in black Luxhide bonded leather.

ORDER NUMBER	DESCRIPTION	UNIT
1 MVL13051 PU30/BL20	Club Chair	EA
2 MVL13052 PU30/BL20	Loveseat	EA
3 MVL13053 PU30/BL20	Sofa	EA





DUET PLASTIC COLOURS

BLK	Night
BZB	Buzz Blue
IVC	Cloud
LAB	Latte
SAR	Scarlet
SHW	Shadow



1

4

A GLOBAL™ DUET™ STACKING TABLE AND CHAIR

High density stacking tables and chairs that are suitable for any multi-use learning space. Polypropylene withstands the test of time. Steel rod chrome frame with sled base. Chairs have a weight capacity of 300 lbs.

ORDER NUMBER	DESCRIPTION	UNIT
1 DTS1828P	Standard frame, 28"W×18"D	EA
2 DTA1832P	Wheelchair accessible, 32"W×18"D	EA
3 DTS1828PG	Ganging frame, 28"W×18"D	EA
4 6621 __CM	Chair	EA



B STOREX® WOBBLE CHAIR

Adjustable seat height of 12-18" in 2" increments allows these stools to grow with your students. An extra-thick padded seat allows for comfortable all-day use. Tamper-proof adjustable height. The rubberized non-skid base is angled for improved posture and provides stability, even when over-tipped. Colours: 0 Black, 1 Blue, 2 Red, 3 Yellow, 4 Green.



C GLOBAL™ DUET™ CHAIR WITH TABLET ARM AND BACK PACK RACK

Tablet arms are extremely rugged, suitable for armed forces and student use. Tablet hinges up to allow ease of egress, and forward/back to accommodate any body size comfortably. Features non-marking glides suitable for both carpet and hard surfaces. Solid steel rod frame and polypropylene seat and back. Hardwood veneer plywood tablet with lacquered edge. Black.



ORDER NUMBER	DESCRIPTION	UNIT
0030_U01C	Specify colour	EA

ORDER NUMBER	DESCRIPTION	UNIT
1 6621TRP BLK CM	Right handed	EA
2 6621TLP BLK CM	Left handed	EA

Call for more model & fabric selections. Freight charges may apply. Check online for the most current price. **543**

Chairs – gaming

NEW!



A ANDA SEAT DARK KNIGHT SERIES GAMING CHAIR

The body-shaping foam provides all-day comfort. Excellent odour control and antibacterial properties. Pneumatic seat height adjustment. Multi-Function Tilt. Lumbar support. Tilt tension adjustment. Height adjustable arms. Articulating arm caps. SGS certified durable PVC leather.

ORDER NUMBER	DESCRIPTION	UNIT
AD12XL-DARK-B-PV/C-B02	High back	EA

NEW!



B ANDA SEAT ASSASSIN KING SERIES GAMING CHAIR

The body-shaping foam provides all-day comfort. Excellent odour control and antibacterial properties. Back angle adjustment up to 160°. Tilt lock. Adjustable lumbar support. Headrest. Height adjustable arms. Articulating armcaps. SGS certified durable PVC leather. Black/White/Red.

ORDER NUMBER	DESCRIPTION	UNIT
AD4XL-03-BWR-PV-W02	High back	EA

NEW!



C ANDA SEAT AXE SERIES GAMING CHAIR

Perfect human-oriented ergonomic chair especially designed for professional gaming as well as for the office. Pneumatic seat height adjustment. Multi-Function Tilt. Adjustable back angle. Lumbar support. Tilt tension adjustment. 2D Arms. PVC leather.

ORDER NUMBER	DESCRIPTION	UNIT
AD5-01-BW-PV-W02	High back	EA



NEW!

D ERGOPIXEL TERRA GAMING DESK

Manage, hide, and store cables and tech essentials with proprietary ecosystem of magnetic accessories and built-in cable management tray. Features carbon fibre desktop, waterproof mouse pad, sturdy construction with cable wire cover, cup and headset holders, and non-slip rubber base. 176 lb. capacity. 55 1/8"W x 23 5/8"D x 29 1/2"H.

ORDER NUMBER	DESCRIPTION	UNIT
1 ADS-GD-0001	Black	EA
2 ADS-GD-0002	Black and Red	EA

544 Call for more model & fabric selections. Freight charges may apply. Check online for the most current price.

Chairs – ergonomic features



A – TENSION ADJUSTMENT

Increase or decrease to match body weight. Allows you to rock comfortably, without heavy pushing, reducing muscle fatigue.



B – CHAIR TILT LOCK

Lock the tilt movement in one or more position(s) to accommodate your working posture. Allows you to lock your chair in a comfortable and supportive position (either single position or infinite style).



C – SEAT HEIGHT

Raise or lower to allow your feet to rest flat on the floor. Avoids pressure under your thighs, easing blood flow.



D – BACK/LUMBAR HEIGHT

Raise or lower to position lumbar support in your lumbar area. Reduces likelihood of back pain.



E – SEAT DEPTH

Change the depth of the seat to accommodate the length of your thighs. Keeps your back in contact with the backrest while avoiding pressure behind your knees.



F – SEAT ANGLE ADJUSTMENT

Forward and/or rearward. Allows seat to tilt forward, changing the angle of your thighs in relation to the floor. Helps reduce disc pressure during forward leaning tasks.



G – BACK ANGLE

Adjust to change the angle of your torso in relation to your thighs. Helps reduce disc pressure and relaxes your back muscles.



H – ARM HEIGHT

Raise or lower to support your forearms. Reduces muscular effort in neck and shoulders, minimizing risk of pain.



I – ARM ANGLE

Tilt to support your forearms in various positions. Reduces muscular effort in neck and shoulders, minimizing risk of pain.



J – KNEE-TILT MOVEMENT

Chair tilts from a pivot point at the front of the seat, keeping your feet on the floor as you rock. Maintains stability while enhancing blood flow.



L – SYNCHRO-TILT MOVEMENT

Backrest reclines at a faster rate than the seat, increasing the angle between your torso and thighs. Enhances comfort and encourages dynamic body movement.



M – WATERFALL SEAT EDGE

Reduces pressure at the back of your knees, contributing to good blood flow.



N – PROPERLY CONTOURED CUSHIONS

Support the body, effectively, allowing you to sit longer without discomfort.



P – VIBRATING BACK / SEAT

Soothing effect contributes to your relaxation during work breaks.



Q – WIDTH ADJUSTABLE ARMS

Allows outward movement of armrests to match shoulder breadth. Ensures armrests properly support forearms, reducing muscular effort in neck and shoulders.



Top View

R – ARM ROTATION

Rotate armcaps to support your forearms in various positions. Reduces muscular effort in neck and shoulders, minimizing risk of pain.



S – CENTRE-TILT MOVEMENT

Chair tilts from a pivot point under the centre of the seat, allowing you to rock. When your feet are well supported, blood flow is enhanced.



T – PUSH BUTTON

Push to activate control. Location within view, increases likelihood of making an adjustment. Promotes good posture as you move to various positions.



U – SOFT DESCENT PNEUMATIC LIFT

Gently and gradually lowering the seat helps you easily select proper seat height without causing a jerking motion.



V – LUMBAR DEPTH ADJUSTMENT

Increase or decrease curvature of the back to match the profile of your lower back. Enhances comfort and support in the lower lumbar area.

Chairs – fabric options

Jenny



JN25 Silver Lining



JN26 Oatmeal



JN27 Sunflower



JN30 Melon

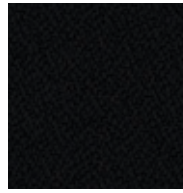

JN02 Ebony



JN03 Slate



JN28 Cascade

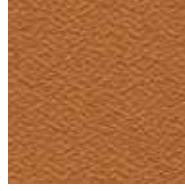

JN29 Harvest



JN32 Green Grass



JN07 Vermilion



JN11 Charcoal



JN08 Admiral



JN31 Berry

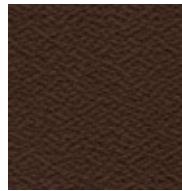

JN33 Roast

Luxhide



BL28 (PU38/BL28)
White



BL24 (PU34/BL24)
Dark Brown

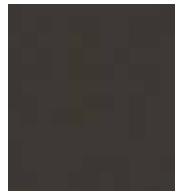

BL27 (PU37/BL27)
Charcoal



BL20 (PU30/BL20)
Black

Quilt



QL10 Black

Allante Free

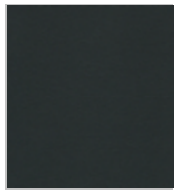

Ink Black (A16F)

Waterfall



WA40 Trance



WA41 Tryst



WA42 Splash



WA46 Rainforest

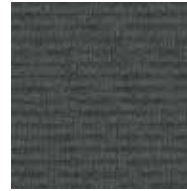

WA50 Grand



WA43 Victoria



WA44 Imagine



WA45 Sky

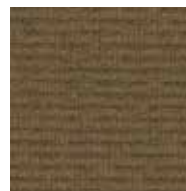

WA51 Rushing



WA52 Magestic



WA47 Rumble



WA48 Prism

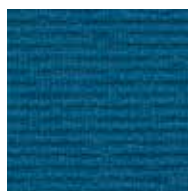

WA49 Tranquility



WA53 Pacific



WA54 Dance

Terrace



TC61 Tigerlily



TC63 Cobble



TC62 Shadow



TC64 Cherry Blossom

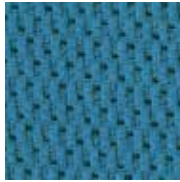

TC65 Bluebell



TC66 Apple



TC68 Cerise



TC69 Twilight



TC70 Wintergreen



TC72 Pine Cone



TC73 Flirt

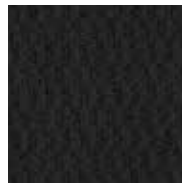

TC74 Echo



TC67 Haze

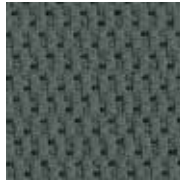

TC71 Ironwork

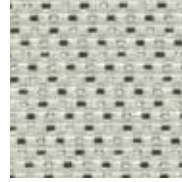

TC75 Glacier

Urban



UR11 Ocean Blue

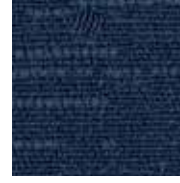

UR12 Blue Bayou



UR13 Green Grass



UR15 Beach Day

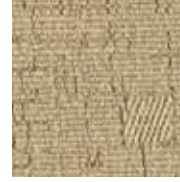

UR16 Boardwalk



UR17 Earth

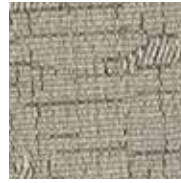

UR19 White Sand

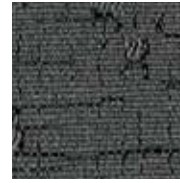

UR20 Granite Rock

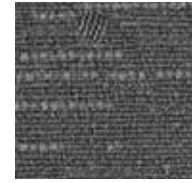

UR21 Gravel Road

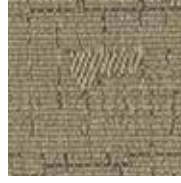

UR14 Sandcastle



UR10 Red Rose



UR22 Black Coal



UR18 Brown Ridge

Fusion

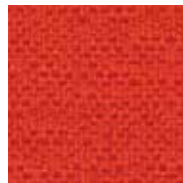

FU74 Tomato

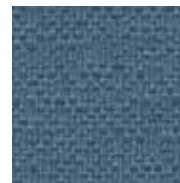

FU79 Cadet

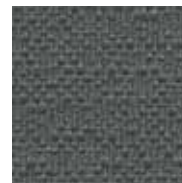

FU81 Graphite



FU71 Tangerine



FU78 Poppy



FU85 Carbon



FU73 Moss



FU75 Aqua



FU82 Viola

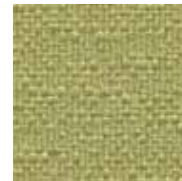

FU72 Fresh



FU80 Oasis

Chair mats



CM13233PB



A DEFLECTO® EARTH SOURCE® CHAIR MATS

Free and Clear® non-orthophthalate, non-cadmium formula promotes a healthy work environment while offering exceptional clarity without harsh chemicals. Contains 30% biobased content made from renewable plant-based resources, providing a natural alternative to petroleum-based vinyl chair mats. Certified for low chemical emissions and healthier indoor air. Greenguard Gold Certified. Limited lifetime warranty.

ORDER NUMBER	DESCRIPTION	UNIT
1	CM13233PB Low Pile, 45"×53" with lip	EA
2	CM13443FPB Low Pile, 46"×60" with lip	EA
3	CM2E232PB Hard Floor, 45"×53" with lip	EA
4	CM2E442FPB Hard Floor, 46"×60" rectangle	EA



CM21242PC



B DEFLECTO® POLYCARBONATE ALL DAY USE CHAIR MATS

Extremely durable and resilient chair mat for all flooring types and Big & Tall applications. Highly rigid, hard surface provides less friction and dishing compared to traditional chair mats. Heavy weight chair mat for anytime use on all pile carpets and hard floors. Protects flooring from caster wear, spills and heavy traffic. Exceptional clarity highlights the beauty of your fine flooring. Greenguard Gold Certified. Limited lifetime warranty.

ORDER NUMBER	DESCRIPTION	UNIT
1	CM11242PC Studded, 45"×53" rectangle	EA
2	CM11442FPC Studded, 46"×60" rectangle	EA
3	CM21242PC Hard floors, 45"×53" rectangle	EA
4	CM21442FPC Hard floors, 46"×60" rectangle	EA



CM2142DUO



C DEFLECTO® DUOMAT CHAIR MATS

One mat designed to protect both carpet and tile floors. Exclusive SuperGrip® coating - it stays where you put it. Do not use on laminate or hard wood flooring as the coating may damage the surface finish. Anti-slip protects mat from moving. Free and Clear® non-orthophthalate, non-cadmium formula promotes a healthy work environment while offering exceptional clarity and durability. Greenguard Gold Certified. Limited Lifetime Warranty.

ORDER NUMBER	DESCRIPTION	UNIT
1	CM23142DUO 36"×48", rectangle	EA
2	CM23232DUO 45"×53", with lip	EA
3	CM23442FDUO 46"×60", rectangle	EA



CM24242BLKSS



D DEFLECTO® ERGONOMIC SIT-STAND® CHAIR MATS

Dual purpose - ergonomic mat is designed for use with adjustable height sit-stand workstations. Combines the ease of chair mobility with the comfort of anti-fatigue support foam. A superior performing medium weight black chair mat built for all day use, married with the comfort of anti-fatigue support foam. 3/8" anti-fatigue support foam offers optimal cushion and resilience, providing support for back, legs and feet. Non-slip anti-fatigue bottom surface designed to reduce friction on hard floor surfaces. Free and Clear® non-orthophthalate, non-cadmium formula promotes a healthy work environment while offering exceptional clarity and durability. Green Gold Certified.

ORDER NUMBER	DESCRIPTION	UNIT
1	CM24242BLKSS 45"×53"	EA
2	CM24442FBLKSS 46"×60"	EA



CM15443F



A DEFLECTO® ROLLAMAT FREQUENT PLUS USE CHAIR MAT FOR MEDIUM PILE CARPET

The right choice for results-driven professionals. Thicker mat offering remarkable protection. Studded design secures mat from moving while protecting carpet from caster wear, spills and heavy traffic. Medium weight chair mat for frequent use on carpets up to 1/2" thick. Smooth beveled edge for easy carpet to mat transition. Free and Clear® non-orthophthalate, non-cadmium formula promotes a healthy work environment while offering exceptional clarity and durability. Greenguard Gold Certified. Limited lifetime warranty.

ORDER NUMBER	DESCRIPTION	UNIT
1 CM15113	36"×48", with lip	EA
2 CM15233	45"×53", with lip	EA
3 CM15443F	46"×60"	EA



CM24232



B DEFLECTO® SUPERMAT FOR HARD FLOORS

A status statement for the mainstream specialist. Superior performance. Non-studded design protects hard floor surfaces from caster wear, spills and heavy traffic. Ideal for all day use on wood, tile, laminate and other hard floors. Easy-glide rolling surface provides effortless chair movement. Classic straight edge finish. Free and Clear® non-orthophthalate, non-cadmium formula promotes a healthy work environment while offering exceptional clarity and durability. Greenguard Gold Certified. Limited lifetime warranty.

ORDER NUMBER	DESCRIPTION	UNIT
1 CM24232	45"×53", with lip	EA
2 CM24442F	46"×60"	EA



CM13113



C DEFLECTO® DURAMAT MODERATE USE CHAIR MATS FOR LOW PILE CARPETING

The dependable difference for the casual user. Light weight, durable performance for moderate use on carpets up to 3/8" thick. Easy-glide rolling surface provides effortless chair movement. Studded design secures mat from moving while protecting carpet from caster wear, spills and heavy traffic. Free and Clear® non-orthophthalate, non-cadmium formula promotes a healthy work environment while offering exceptional clarity and durability. Smooth beveled edge for easy carpet to mat transition. Greenguard Gold Certified. Limited lifetime warranty.

ORDER NUMBER	DESCRIPTION	UNIT
1 CM13113	36"×48", with lip	EA
2 CM13233	45"×53", with lip	EA
3 CM13443F	46"×60"	EA
4 CM13433F	46"×60", with lip	EA



CM14443F



D DEFLECTO® SUPERMAT FREQUENT USE CHAIR MATS FOR MEDIUM PILE CARPETING

A status statement for the mainstream specialist. Superior performance. Studded design secures mat from moving while protecting carpet from caster wear, spills and heavy traffic. Medium weight chair mat for frequent use on carpets up to 1/2" thick. Smooth beveled edge for easy carpet to mat transition. Free and Clear® non-orthophthalate, non-cadmium formula promotes a healthy work environment while offering exceptional clarity and durability. Greenguard Gold Certified. Limited lifetime warranty.

ORDER NUMBER	DESCRIPTION	UNIT
1 CM14233	45"×53", with lip	EA
2 CM14443F	46"×60"	EA

Standing Desk Essentials



Ergonomic Sit•Stand® Mat

2-in-1 Anti-Fatigue Mat plus Chair Mat

Dual-purpose, ergonomic mat designed for use with adjustable height workstations to help promote wellness.

Standing Desk Accessories

The perfect complement to your Sit•Stand® Mat

Desk organization for the modern ergonomic office. Deflecto's standing desk accessories help boost productivity, minimize distraction, and streamline your routine without taking up valuable desk space.



CUP HOLDER WITH SUPPLY TRAY



SMALL DESK ORGANIZER



LARGE DESK ORGANIZER



FILE ORGANIZER



24" PRIVACY PANEL

Solutions that stand up to the task.

deflecto®

Sit/Stand – converters



A VICTOR® ELECTRIC STANDING WORKSTATION CONVERTER

Transform any sit down desk into a sit or stand desk. Electric motor allows easy custom height adjustment with the push of a button and ergonomic placement of monitor, keyboard, mouse, telephone and papers while standing. 28"W×23"D×20"H. 3-year limited warranty. Black.



ORDER NUMBER	DESCRIPTION	UNIT
1 DC400	Single monitor	EA
2 DC450	Dual monitor	EA



B VICTOR® HIGH RISE SIT-STAND DESK CONVERTER

Transform any sit down desk into a sit or stand desk. Gas strut design allows easy custom height adjustment of both desk and monitor. Work surface lowers to flush with desktop. Heavy steel base prevents tipping. Rear portion of desk is tapered to fit corner cubicles. Extra-large worksurface for accessories. Wood construction with laminate coating. 28"W×23"D×15½"H. Black.

ORDER NUMBER	UNIT
DC300	EA



C VICTOR® SIT-STAND DESK CONVERTER

Transform any sit down desk into a sit or stand desk. Ergonomic placement of laptop, keyboard, mouse or papers while standing. Gas strut design allows easy height adjustment with the twist of a knob. Allows for two 22" monitors. Surface can be raised up to 15½". 28"W×23"D. Black.



ORDER NUMBER	UNIT
DC350A	EA

A FELLOWES® CORSIVO™ SIT-STAND WORKSTATION

Change positions easily with gas spring height adjustment. The two-tiered larger work surface can accommodate flexible set up options, holding two monitors or a monitor and a laptop. Keep your phone or other accessories within reach with the device channel. Easy assembly only requires the attachment of the optional keyboard platform. 15 ½" range of height adjustment. 31 ½"W×24 ½"D. 1 Year Limited Warranty.

ORDER NUMBER	UNIT
8091001	EA



B 3M™ STANDING DESK

Retrofit existing office spaces into sit/stand workstations. Gas assisted height adjustment provides smooth, quiet and infinite height adjustment to quickly and easily set to user's ideal ergonomic position. Large work surface accommodates 2" - 24" monitors. Separate keyboard surface adjusts with primary work surface. Adjustable tilt from -10°/+10° for ergonomic typing position while sitting or standing. 35 lb capacity. 35½"W×15½"D. Black.

ORDER NUMBER	UNIT
SD60B	EA



D HORIZON® GOYA™ SIT-STAND WORKSTATION

Comes fully assembled and has gas assisted height adjustment that provides smooth, quiet and infinite height adjustment. Can accommodate 2×24" monitors. Has +/- 10° keyboard surface tilt. Supports up to 30 lbs. and weights 40 lbs. 35½"W×24"D×5 - 20"H.

ORDER NUMBER	UNIT
SSW-02	EA



C ERGOTRON® WORKFIT-T SIT-STAND DESKTOP WORKSTATION

Ultra easy standing desk solution converts a tabletop into a sit-stand workstation. Instantly move to sit or stand as you work, simply release the handbrake levers to position the surface higher or lower. Keyboard moves in tandem with the worksurface yet always remains positioned below it. Provides 15" of easy height adjustment. Supports up to 35 lbs of external weight. 35"W×25"D. Black.

ORDER NUMBER	UNIT
33-397-085	EA

NEW!



E ERGOTRON® WORKFIT-TL SIT-STAND WORKSTATION

Stable workstation sits right on top of most surfaces 24 deep or larger; no mounting or clamping required. Counterbalancing mechanism uses Constant Force™ technology to facilitate quick height adjustment. Keyboard moves in tandem with the worksurface and is positioned 4.5 below it. Provides 15" of easy height adjustment. Supports up to 40 lbs of external weight. 37½"W×25"D. Black.

ORDER NUMBER	UNIT
33-406-085	EA



A OFFICES TO GO® IONIC PERSONAL HEIGHT ADJUSTABLE TABLE

Dynamic load capacity 8 kg. BIFMA compliant. Absolute Acajou finish. 28"W×19"D×28¾"- 44"H.

ORDER NUMBER	UNIT
ML2819PPT ACJ	EA



B VICTOR® HIGH RISE™ MOBILE ADJUSTABLE STANDING DESK

Ergonomic benefits of a sit to stand desk plus the mobility of a cart. Sturdy steel construction and heavy duty gas strut. Worksurface is laminate. 31"W×22"D×29"- 44"H.

ORDER NUMBER	UNIT
DC500	EA



C ERGOTRON® WORKFIT-TX SIT-STAND DESKTOP WORKSTATION

Designed to offer advanced ergonomics, this easy standing desk solution converts a tabletop into a sit-stand workstation. The X-shaped lift folds down within inches of the desk for an extremely low profile that keeps the right monitor to keyboard tray spacing. The height adjustable, back tilt keyboard sits below the work surface and moves in tandem with the workstation. Provides 17" of vertical height adjustment. Supports up to 40 lbs of external weight. 32"W×27"D. Black.

ORDER NUMBER	UNIT
33-467-921	EA

D ERGOTRON® WORKFIT-S WITH WORKSURFACE+

Convert any surface into an adjustable-height standing desk with the WorkFit-S attachment. Make computing comfortable for prolonged periods - stand up whenever you want. Simple to use, with the push or pull of a hand, instantly raise or lower keyboard and display in one easy motion. Ergonomic back-tilt keyboard tray with left or right mouse tray ensures wrists remain in neutral. LCD/keyboard tray adjusts 18" in tandem. LCD adjusts 5" independently. Maximum load on height-adjustment assembly is 18 lbs. (33-350-200) and 25 lbs. (33-349-200). 23"W×15"D Worksurface and 27"W×9"D keyboard tray. Black.

ORDER NUMBER	DESCRIPTION	UNIT
1 33-350-200	Single monitor	EA
2 33-349-200	Dual monitor	EA



A LINKS HEIGHT ADJUSTABLE BASES

These electronic metal bases come with controls that have 4 programmable settings and a height range of 23 1/2" to 49 1/2". Travels at 1 1/2" per second without load and has a soft start/stop. Bases are UL/CSA approved. Bases are available in Black, Silver and White.



ORDER NUMBER	DESCRIPTION	UNIT
--------------	-------------	------

BASES

1 TBL-AHTB-DBL	2 Leg Base, weight capacity: 225 lbs.	EA
2 TBL-AHTB-TRP	3 Leg Base, weight capacity: 337 lbs.	EA

LAMINATE TOPS

3 TOP-2448-OG	48"W×24"D	EA
4 TOP-3048-OG	48"W×30"D	EA
5 TOP-2460-OG	60"W×24"D	EA
6 TOP-3060-OG	60"W×30"D	EA
7 TOP-2472-OG	72"W×24"D	EA
8 TOP-3072-OG	72"W×30"D	EA

LAMINATE MODESTY PANELS

9 AH-MOD-1248	48"W×12"H	EA
10 AH-MOD-1260	60"W×12"H	EA
11 AH-MOD-1272	72"W×12"H	EA

See page 605 for laminate colour options.



B OFFICES TO GO™ IONIC™ QUICK ASSEMBLY HEIGHT ADJUSTABLE TABLES

Quick assembly electric height adjustable bases with leg columns preassembled to telescopic cross bar assembly including electric motors. Unfold leg columns, attach feet and worksurface support to base, fasten assembly to top, plug in and use. Easy to use up-down controller with digital read-out and four memory programmable positions. Laminate worksurface is 1" thick with matching edge. Tungsten base.

ORDER NUMBER	DESCRIPTION	UNIT
--------------	-------------	------

TABLE

1 ML48242QHT	46"W×23"D	EA
2 ML60302QHT	58"W×29"D	EA
3 ML72302QHT	70"W×29"D	EA

RETURN

4 ML36242QHR	35"W×23"D	EA
5 ML42242QHR	46"W×23"D	EA



A HDL® CALYPSO ELECTRIC HEIGHT ADJUSTABLE BASES

Premium quick-assembly goes together in minutes. Heavy Duty 3-stage steel frame design. Actuator system with synchronized motor in each leg and anti-collision function. Motor operates at 1.3" per second and is whisper quiet. Low power consumption in standby mode. Features 3 programmable memory positions including home. Includes 10 mm adjustable glides. Height ranges from 24 3/8" to 50". 5-year warranty. Certified X5.5-2014. Silver.

ORDER NUMBER	DESCRIPTION	UNIT
1 CAL-E1-2LEG	2 Leg Base, 265 lb. capacity	EA
2 CAL-E1-3LEG	3 Leg Base, 320 lb. capacity	EA



B HDL® ATHENA ELECTRIC HEIGHT ADJUSTABLE BASES

Quick-assembly electric base goes together in minutes. Actuator system with synchronized motor in each leg. Features 4 programmable memory positions including home. Height ranges from 27 1/2" to 45 1/2". ANSI/BIFMA Certified X5.5-2014. Silver.

ORDER NUMBER	DESCRIPTION	UNIT
1 ATH-E1-2LEG	2 Leg Base, 220 lb. capacity	EA
2 ATH-E1-3LEG	3 Leg Base, 330 lb. capacity	EA



C HDL® INNOVATIONS TABLE TOPS

Use with height adjustable bases. 1" thick commercial grade laminate finish with 2mm PVC edging. See page 606 for laminate colour options in addition to Pure White.

ORDER NUMBER	DESCRIPTION	UNIT
1 INV-2448TOP	47 1/4"W×23 3/4"D	EA
2 INV-3060TOP	59 1/4"W×29 1/2"D	EA
3 INV-3066TOP	65"W×29 1/2"D	EA
4 INV-3072TOP	71"W×29 1/2"D	EA



D HDL® INNOVATIONS MODESTY PANELS

For use with height adjustable tables. Includes mounting clips or brackets.

ORDER NUMBER	DESCRIPTION	UNIT
1 INV-MP1-1548PLX-SL	43 1/2"W×15"H Plexiglas®	EA
2 INV-MP1-1560PLX-FR-SL	55 1/4"W×15"H Frosted Plexiglas®	EA
3 INV-MP1-1448LAP-GR	47 1/4"W×14"H Grey laminate	EA
4 INV-MP1-1460LAP-GR	57 1/4"W×14"H Grey laminate	EA
5 INV-MP1-1472LAP-GR	69"W×14"H Grey laminate	EA



A DEFLECTO® ERGONOMIC SIT-STAND™ MATS

Dual purpose - ergonomic mat is designed for use with adjustable height sit-stand workstations. Combines the ease of chair mobility with the comfort of anti-fatigue support foam. A superior performing medium weight black chairmat built for frequent use, married with the comfort of anti-fatigue support foam. 3/8" anti-fatigue support foam offers optimal cushion and resilience, providing support for back, legs and feet. Non-slip anti-fatigue bottom surface designed to reduce friction on hard floor surfaces.

ORDER NUMBER	DESCRIPTION	UNIT
1 CM24242BLKSS	45"×53"	EA
2 CM24442FBLKSS	46"×60"	EA



C FELLOWES® ACTIVEFUSION™ ANTI-FATIGUE MAT

Unique shape promotes stretching and movement throughout the day. Bevelled edge helps avoid tripping hazards. Black.

ORDER NUMBER	DESCRIPTION	UNIT
8707102	36"×24"	EA



NEW!

E EXPONENT® PREMIUM ANTI-FATIGUE MAT

Supports and relieves pressure on feet, back, neck, and shoulders. Improves work efficiency. Features glide movement with foot control. ¾" thick. Black.

ORDER NUMBER	DESCRIPTION	UNIT
50802	29"×19"	EA



B FELLOWES® ANTI-FATIGUE WELLNESS MAT

Encourages subtle movement to prevent fatigue. Use with any sit-stand for extra support while standing. Bevelled edge helps avoid tripping hazards. Black.

ORDER NUMBER	DESCRIPTION	UNIT
8707002	36"×24"	EA



D FLOORTEX® COMFORT ANTI-FATIGUE MAT

Provides fatigue relief in light to medium applications. Patented Zedian sponge combines softness and resilience. Flexible even in low temperatures. ¾" thick. 1-year warranty. Black.

ORDER NUMBER	DESCRIPTION	UNIT
FCOMK2424BK	24"×24"	EA



F FLOORTEX® AFS-TEX™ SYSTEM 2000 ANTI-FATIGUE MAT

Reduces pressure on the body by up to 40%, reducing strain on feet, legs, knees, and back caused by prolonged standing. Solid, one-piece polyurethane with anti-microbial protection. Printed design on the surface acts as a reminder to change foot position. Stimulates blood flow for maximum fatigue relief. The contoured, curl-proof edge keeps mat flat. 20-degree bevelled edge for maximum safety. 7/8" thick. 10-year warranty. Colours: **BK** Black, or **GY** Grey.

ORDER NUMBER	DESCRIPTION	UNIT
1 FCA21624X	16"×24"	EA
2 FCA22032X	20"×32"	EA



Shown in **laminated finish Winter Wood**
Chair and accessories shown are not included.

LAMINATE FINISH COLOUR

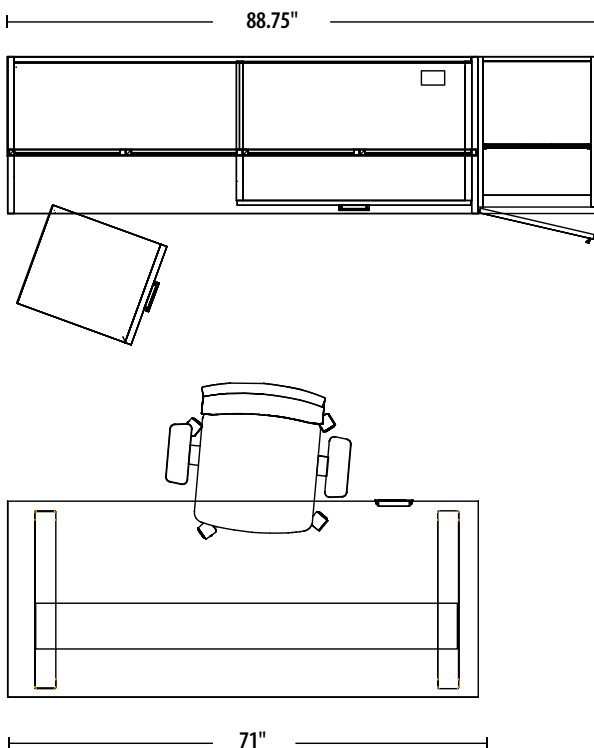

A HDL® INNOVATIONS HEIGHT ADJUSTABLE SUITE

Innovations has the designer edge and the flexibility needed in the modern workspace to accommodate individual needs. High quality construction with 1" thick commercial grade tops and durable 2 mm thick PVC edging. Includes levelling glides. Quick assembly fold-out height adjustable leg frame. Desk height ranges from 24 3/8" to 50".

ORDER NUMBER	DESCRIPTION	UNIT
1 INV-LAYOUT-20-WW	Desk package	EA

PACKAGE COMPONENTS

INV-2472SH	Credenza shell	EA
INV-3672H	Open hutch	EA
INV-72HDRS-AL	72" Glass doors for hutch	EA
INV-3672TB	Tackboard	EA
INV-22360LFX	Open lateral file storage - no top	EA
INV-6518WC	Wardrobe / storage cabinet	EA
INV-MPF	21" Mobile pedestal	EA
INV-CUSH	Mobile pedestal seat cushion	EA
INV-3072TOP	72" Rectangular top	EA
CAL-E1-2LEG	Calypso fold-out electric 2 leg base	EA
INV-MP1-1566PLX	Plexiglass hanging modesty panel	EA



Shown in **laminated finish CH Cherry Henna**
Chairs and accessories shown are not included.

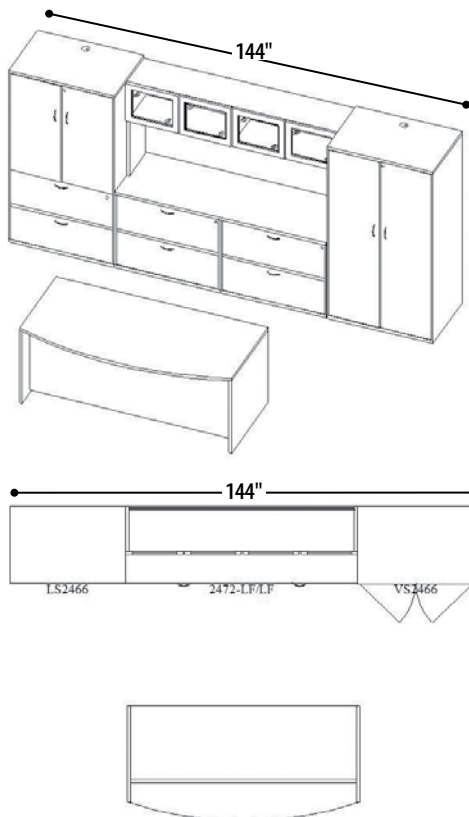

LAMINATE FINISH COLOURS

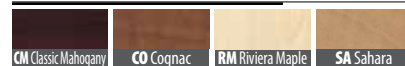

A LINKS® DESK PACKAGE

Links® is designed for executive and management applications. Built with 1" thick tops and 3mm "Tough Guard" matching edging. Call for more size, colour and configuration options.

ORDER NUMBER	DESCRIPTION	UNIT
1 PS375A-CH	Desk Package	EA

PACKAGE COMPONENTS

DSK-3072-LBFTD	Freestanding bow front table desk 36"D×72"W	EA
HUT-1472-36	Open hutch 14"D×72"W×36"H	EA
TB-7219	Tack board for hutch	EA
CAB-243666-VS-P	Vertical storage cabinet, 24"D×36"W×66"H	EA
CAB-243666-LS-P	Vertical lateral file storage 24"D×36"W×66"H	EA
CAB-2472-LFLF-P	Double lateral file credenza 24"D×72"W	EA
DKT-72-HING-SZ	Four glazed hinged doors for 72" hutch	EA



Shown in **laminite finish CP Cappuccino**
Chair shown is not included.



LAMINATE FINISH COLOUR



A LINKS® EXECUTIVE WORKSTATION

Designed for top executive environments; built with solid 25.4 mm (1") thick tops. Overall dimensions: 144" W×108" D.

ORDER NUMBER	DESCRIPTION	UNIT
1 PS360A-CP	Desk Package	EA

PACKAGE COMPONENTS

LTI-3072-48-FP-LR	"L" shaped corner Island, 48/30"D×72"W	EA
DSK-2436-LC	Rectangular 36"W×24"D bridge	EA
DSK-2472-LF	Rectangular 72"W×24"D credenza	EA
HUT-1472-36	Open hutch 72"W×15"D×36"H	EA
TB-7219	Fabric tackboard for 72"W hutch	EA
CAB-243666-LS-P	2 drawer lateral/storage cabinet, locking 24"D×36"W×66"H	EA
CAB-243666-VS-P	Enclosed locking storage cabinet, 24"D×36W×66"H	EA
CAB-1622-LMFF	Locking mobile file/file cabinet, 22"D×16"W	EA
DKT-72-HING	Four laminate hinged door kit for 72"W hutch	EA

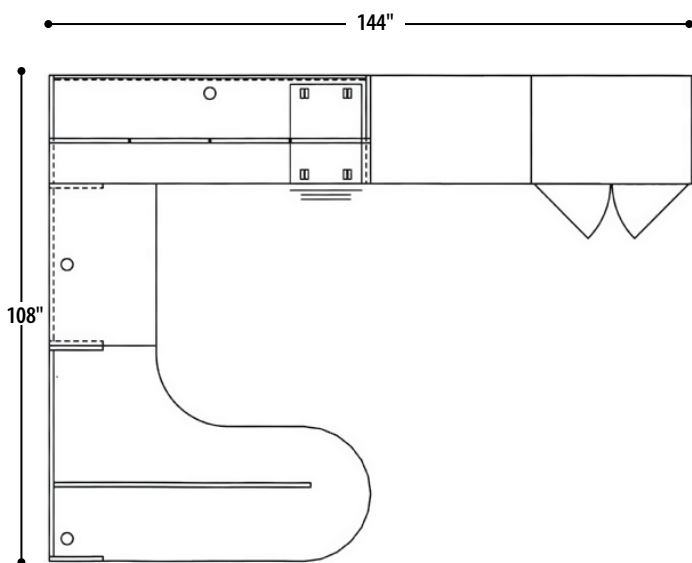



Shown in **laminite finish DES Dark Espresso**
Chairs and accessories shown are not included.

LAMINATE FINISH COLOUR

DES Dark Espresso

A GLOBAL™ ZIRA COLLECTION

Zira is a contemporary desking solution with extensive options to personalize your workspace. For the managerial application or executive office, create a work environment that meets your work surface needs and storage requirements. 1½" thick fluted edge.

ORDER NUMBER	DESCRIPTION	UNIT
1 ZIRA202 DES CF DE P1 3T Z1 HV	Desk Package	EA

PACKAGE COMPONENTS

Z4284EDFL DES CF DE P1 Z1	Delta top Island with faux pedestal, 84"W×42"D×29"H	EA
Z1642TRBR DES CF DE	Transitional bridge 42"W×16"D×29"H	EA
Z16L7SHCL DES CF DE 3T HV	Open storage cabinet with door & cavity with collator	EA
Z36L7EC DES CF DE Z1 HV	16"W×24"D×71½"H 2-File with doors & cavity, 36"W×24"D×71½"H	EA
Z30L7BFCL DES CF DE 3T HV	Personal tower with doors & cavity with collator	EA
Z24L7ESHR DES CF DE	30"W×24"D×71½"H End shelf, 24"W×24"D×71½"H	EA

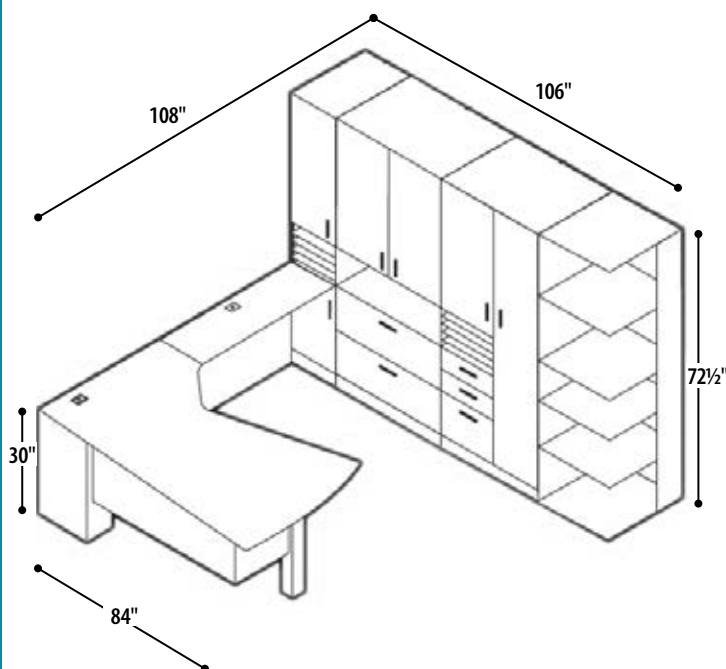



Shown in laminate finish QTM Quartered Mahogany
Chairs and accessories shown are not included.



LAMINATE FINISH COLOUR



QTM3QT Quartered Mahogany

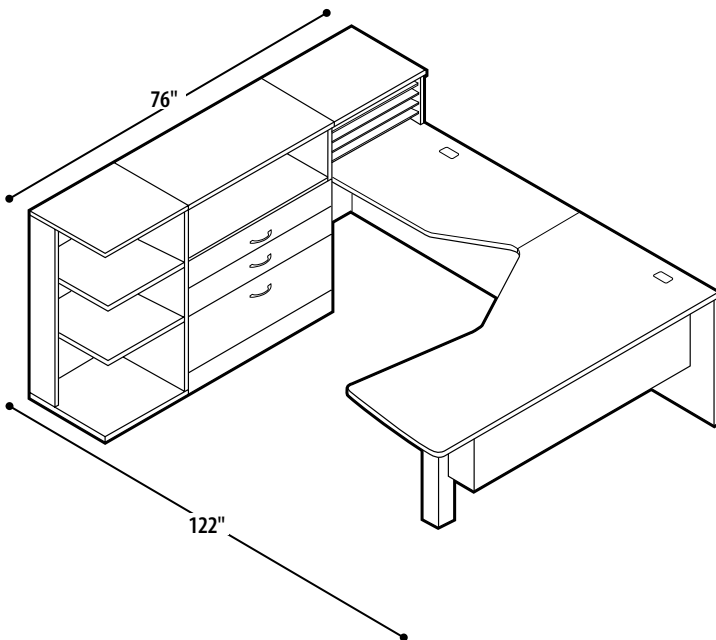

A GLOBAL™ ZIRA™ WORKSTATION

Zira™ is ideal for almost any office application, including shared teaming areas and open plan environments. Components can be freestanding for single workstation configurations or joined together to form multiple work groups.

ORDER NUMBER	DESCRIPTION	UNIT
1 Z1103L QTM3QT-P1-HS	Desk Package	EA

PACKAGE COMPONENTS

Z4272EDFR QTM3QT P1	Delta top Island desk, 42"×72"	EA
Z206016RL QTM3QT	Space saver 60"W×20"D return	EA
Z20M12PH QTM3QT BC	Paper organizer, 20"D x 20"W×11½"H	EA
Z36M4EN QTM3QT BB2 HS	Lateral / storage cabinet 36"W×20"D×41"H	EA
Z20M4ESHL QTM3QT	Open end bookshelf 20"W×20"D×41"H	EA



Shown in **laminated finish ACJ Absolute Acajou**
Chairs and accessories shown are not included.



LAMINATE FINISH COLOURS

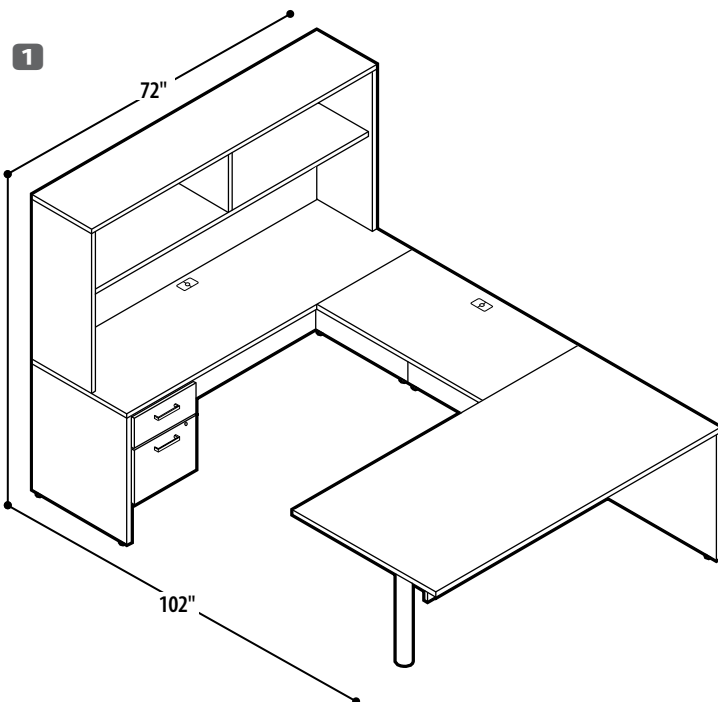

A OFFICES TO GO™ IONIC U SHAPED DESK PACKAGE

With its clean modern form, Ionic is able to support a wide range of workspace applications. Ionic is built to last and is true commercial quality at an affordable price. Tested to meet BIFMA standards and is Greenguard certified.

ORDER NUMBER	DESCRIPTION	UNIT
1 MLP321 ACJ AA	Desk Package	EA

PACKAGE COMPONENTS

ML7236RM	Rectangular shaped island 72"×36"	EA
ML4224FB	Rectangular bridge, 42"×24"	EA
ML7224C	Rectangular credenza shell 72"×24"	EA
ML72H0	Open hutch, 72"W×15"D×36"H	EA
ML22HBF	Locking box / file pedestal	EA

2 ML36H0	Open hutch, 36"W×15"D×36"H	EA
3 ML3624LFT	Locking 2 drawer lateral file, 36" W×24" D	EA
4 ML36DRAG	Glazed doors, 2" W×18"D	ST

562 Call for more model & laminate selections. Freight charges may apply. Check online for the most current price.



Shown in **laminated finish ACJ/DW Absolute Acajou and Designer White**. Chair and accessories shown are not included.



LAMINATE FINISH COLOUR

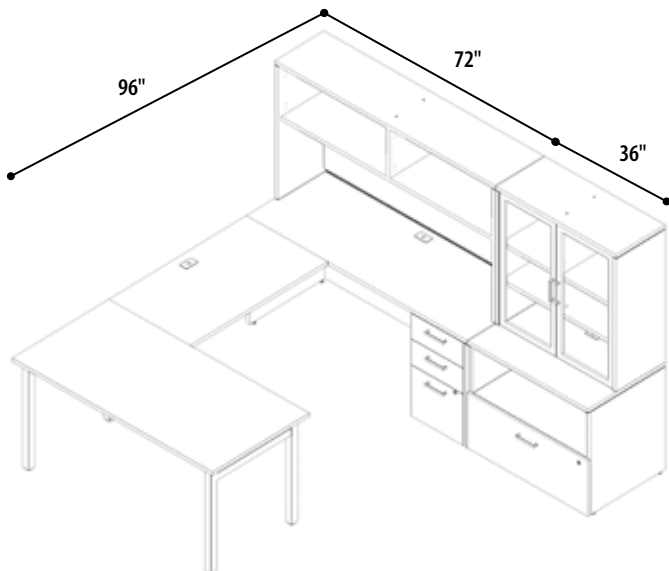

A OFFICES TO GO™ IONIC SUITE

Ionic offers a range of mix and match components that can be easily shared.

ORDER NUMBER	DESCRIPTION	UNIT
1	MLP229 ACJ DW Desk Package	EA

PACKAGE COMPONENTS

ML7230DWL	72"×30" Table w/ 2 legs	EA
ML4224B	42" Flush bridge	EA
ML7224C	72" Credenza	EA
ML22BBF	BBF Full pedestal	EA
ML72HO	72" Open hutch	EA

2	MLP240 Cabinet package	EA
3	ML72TB Tackboard	EA
4	ML22HBF Hanging box/file pedestal	EA



Shown in **laminated finish GD Grey Dusk**
Chairs and accessories shown are not included.

LAMINATE FINISH COLOUR



GD Grey Dusk

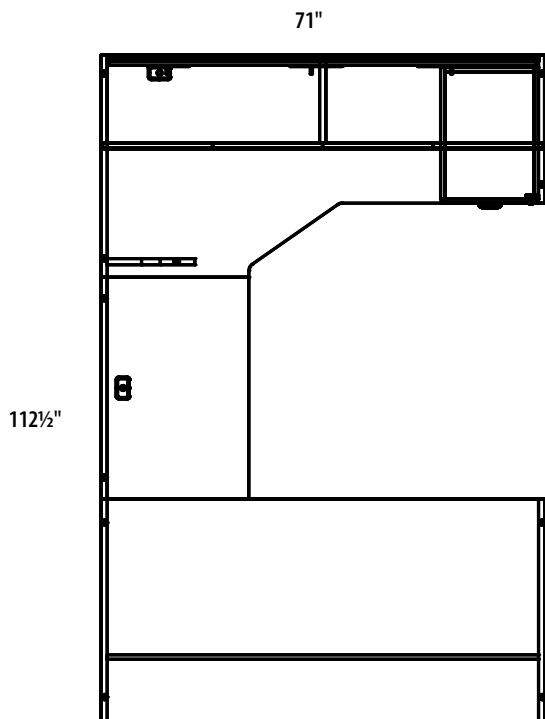

A HDL® INNOVATIONS U WORKSTATION

Innovations has the designer edge and the flexibility needed in the modern workspace to accommodate individual needs. High quality construction with 1" thick commercial grade tops and durable 2 mm thick PVC edging. Includes levelling glides. 71"×112½"

ORDER NUMBER	DESCRIPTION	UNIT
1 INV-LAYOUT-14A-GD	Desk Package	EA

PACKAGE COMPONENTS

INV-3672DS	Desk shell	EA
INV-3672CM	Extended corner module	EA
INV-FPUF	Freestanding pedestal - no top	EA
INV-3672H	72" Open hutch	EA
INV-72HDRS	Laminate doors for hutch	EA
INV-2442RSBR	Return shell	EA
INV-3672TB	Tackboard	EA



Shown in **laminated finish GD Grey Dusk**
Chairs and accessories shown are not included.



LAMINATE FINISH COLOUR

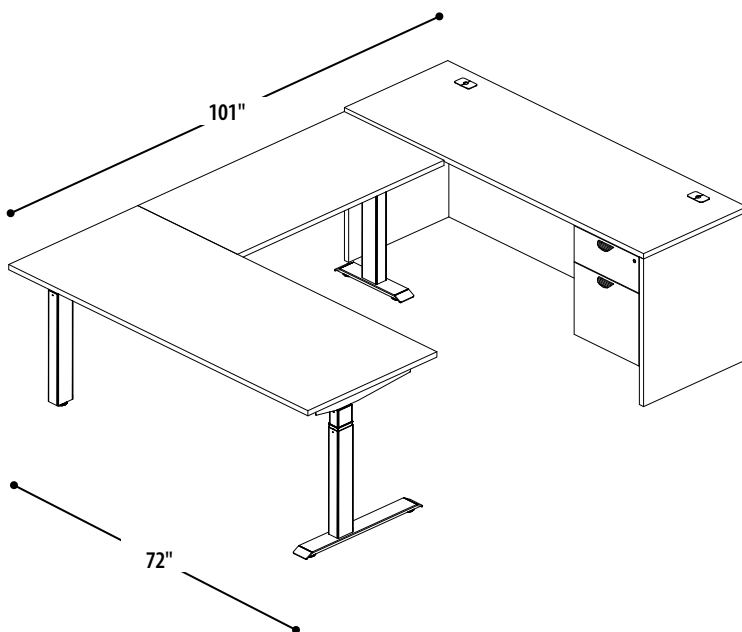

A HDL® INNOVATIONS SERIES HEIGHT ADJUSTABLE SUITE

Innovations has the designer edge and the flexibility needed in the modern workspace to accommodate individual needs. High quality construction with 1" thick commercial grade tops and durable 2mm thick PVC edging.

ORDER NUMBER	DESCRIPTION	UNIT
1 INV-LAYOUT-45-GD	Desk Package	EA

PACKAGE COMPONENTS

INV-2472SH	Credenza shell, 71"×23¾"	EA
INV-2448TOP	Desk top, 24"×48"	EA
CAL-E1-3LEG	3 Leg height adjustable base	EA
INV-HPF	Hanging box/file pedestal	EA
INV-3072TOP	Desk top, 30"×71"	EA

2 INV-3672H	Open hutch, 71"×15"	EA
3 INV-72HDRS	Hutch doors, set of 4	ST
4 INV-3672TB	Tackboard, 68¼"×15¾"	EA



Shown in **laminated finish NM Nutmeg**
Chair shown is not included.



LAMINATE FINISH COLOURS

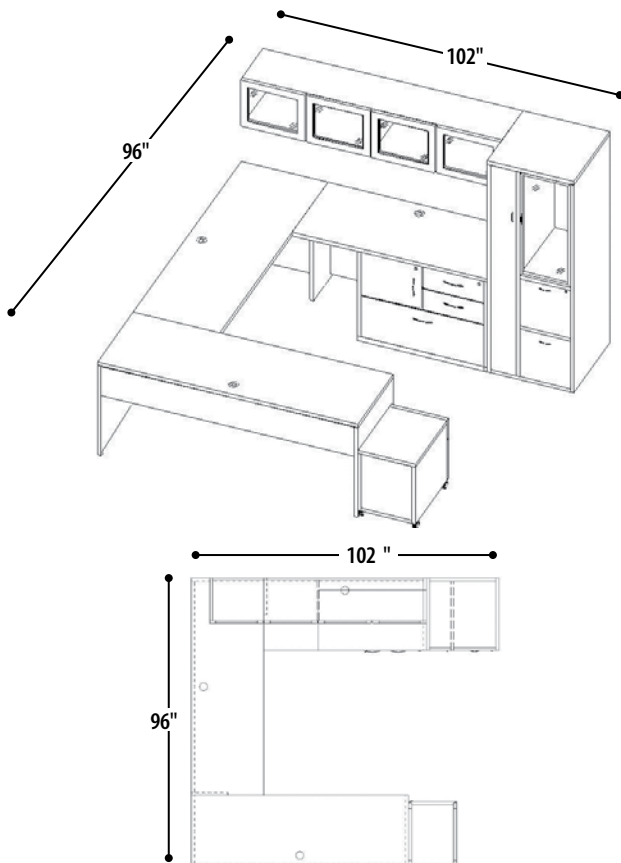
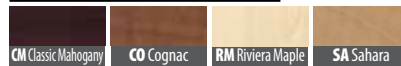

A LINKS® WORKSTATION

Links workstation is designed for open office applications. Ideal for creation of unique areas personalized to your style.

ORDER NUMBER	DESCRIPTION	UNIT
1 PS732- NM	Desk Package	EA

PACKAGE COMPONENTS

DSK-2472-LL	Freestanding work table, left 24"D×72"W	EA
DSK-2472-LF	Freestanding work table 24"D×72"W	EA
DSK-2454-LL	Freestanding work table, left 24"D×54"W	EA
CAB-1622-LMBF-SE	Mobile pedestal box/file with cushioned seat	EA
WMHT-1472-14	Wall mount open hutch 14"D×72"W×14"H	EA
DKT-72-HING-BZ	Four glazed hinged doors for 72" hutch	EA
CAB-2036-LMFC-NT-P	Multi-functional cabinet 20"D×36"W×28"H	EA
CAB-2466-PT-L-FF-BZ-P	Wardrobe/personal storage 24"D×24"W×66"H	EA



Shown in **laminated finish WW Winter Wood**
Chair and accessories shown are not included.

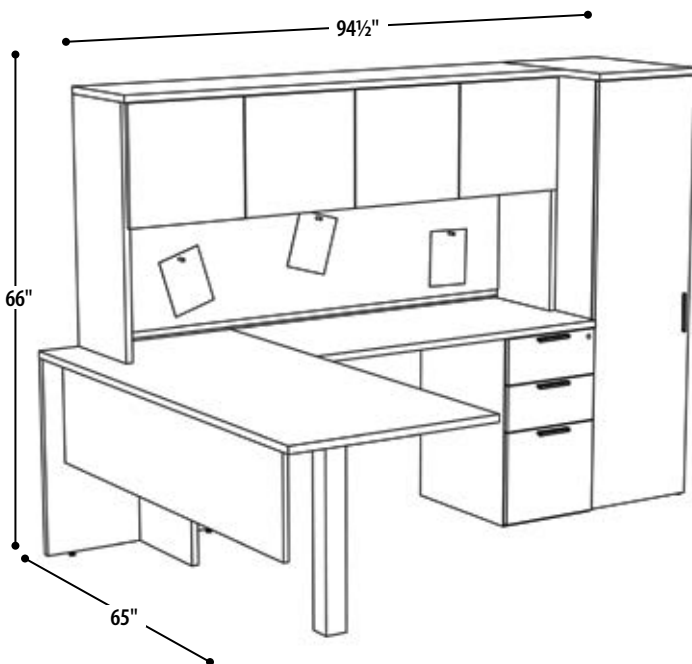

A HDL® INNOVATIONS SERIES WORKSTATION

High quality construction with 1" thick commercial grade tops, durable 2 mm thick matching durable edge. Assembly not included. Limited Lifetime Warranty.

ORDER NUMBER	DESCRIPTION	UNIT
1 INV-LAYOUT-41B-WW	Desk Package	EA

PACKAGE COMPONENTS

INV-3066RLT	Rectangular bullet top desk, 66"W×30"D	EA
INV-2448TOP	Rectangular top, 48"W×24"D	EA
INV-MP1-1460LAP	Modesty panel, 57¼"W×14"H	EA
INV-FPUF	Freestanding pedestal, no top, 15¾"W×21¾"D	EA
INV-6518WC	Wardrobe, 17¾"W×23¾"D	EA
INV-3672H	Open hutch, 71"W×15"D	EA
INV-72HDRS	Hutch doors, set of 4	ST
100-WSCK	Worksurface connecting kit	EA



Shown in **laminite finish DES Dark Espresso**
Chairs and accessories shown are not included.



LAMINATE FINISH COLOUR

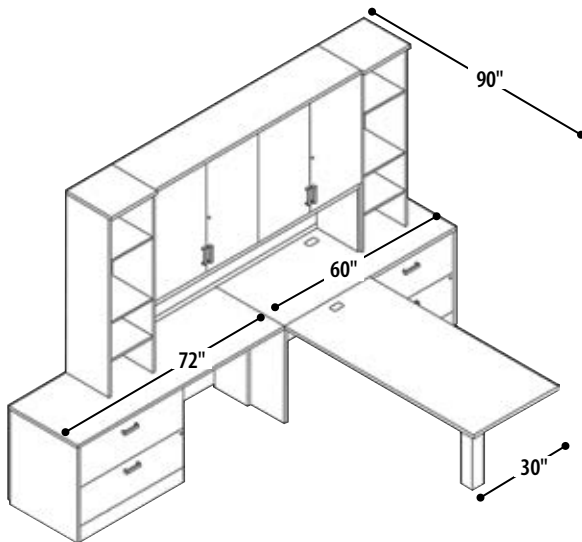

A GLOBAL™ ZIRA MANAGEMENT SUITE

Zira is a contemporary desking solution with extensive options to personalize your work space. For the managerial application or executive office, create a work environment that meets your work surface needs and storage requirements.

ORDER NUMBER	DESCRIPTION	UNIT
1 ZRA544 LL12 DES A3 DE P1 HQ	Desk Package	EA

PACKAGE COMPONENTS

Z2472L	Left connecting table, 72"W×24"D	EA
Z2460T	Freestanding table, 60"W×24"D	EA
Z36L2ES	File/file shell, 36"W×23.4"D	EA
Z30L2ES	File/file shell, 30"W×23.4"D	EA
Z72S55H	Hutch with Doors, 72"W×15"D	EA
Z16S55TN	Table top bookcase, 16"W×16"D (2)	EA
Z3066RI	Island w/monopost, 66"W×29.7"D	EA
ZTB7021	Tackboard, 70"W×21"H	EA

568 Call for more model & laminate selections. Freight charges may apply. Check online for the most current price.



Shown in laminate finish ACJ/DW Absolute Acajou and Designer White

LAMINATE FINISH COLOUR

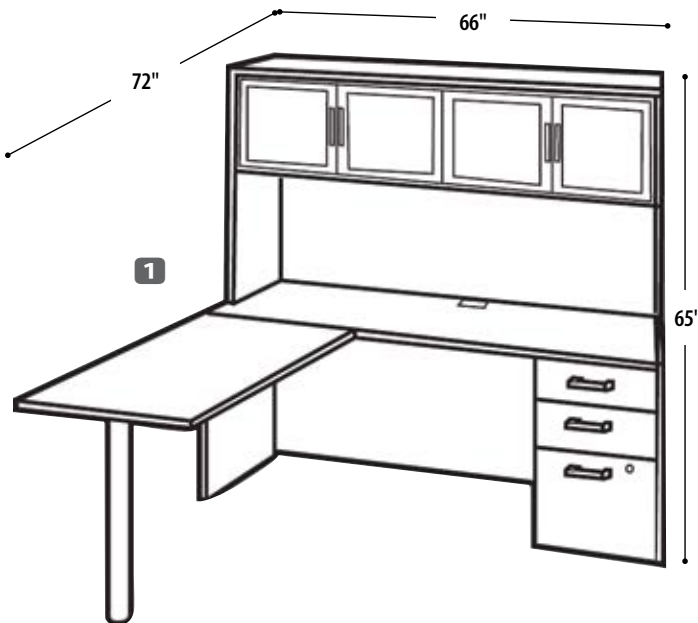
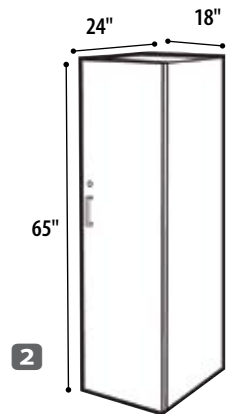

A OFFICES TO GO™ IONIC SUITE

The clean, modern design of Ionic supports a wide range of workspace applications, from cubicles to boardrooms. All drawers have ball bearing over-travel slides. Accented by 2 mm matching edge with black accent line. Features tungsten metal accents with a 3" square mono post leg.

ORDER NUMBER	DESCRIPTION	UNIT
1 MLP519 DWT AA	Desk Package	EA

PACKAGE COMPONENTS

ML66HO	66" Open hutch	EA
ML33DRAG	Glazed door set (2)	EA
ML6624C	Credenza	EA
ML22BBF	Box/box/file pedestal	EA
ML4824RI	Island with mono post	EA

2 ML6518WDL	Personal wardrobe 18"W×24"D×65"H	EA
-------------	-------------------------------------	----



Shown in laminate finish LN/TW London Fog and True White
Chair and accessories shown are not included.

LAMINATE FINISH COLOUR

LN/TW London Fog/True White

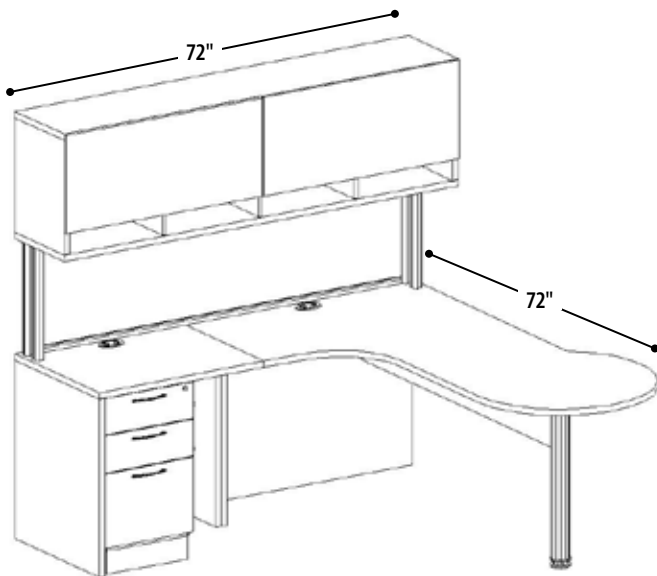

A LINKS® WORKSTATION

Links® combines beautifully coordinated pieces for flexible office requirements. Call for more design options.

ORDER NUMBER	DESCRIPTION	UNIT
1 PS191-LN/TW	Desk Package	EA

PACKAGE COMPONENTS

FTI-2472-42-LL-C3	F-Shaped Island with single silver post leg	EA
2472FP10F	Modesty panel 10"H	EA
DSK-2430-LR	Desk 24"D×72"W	EA
CAB-1622-LOBBF-P	Box/box/file pedestal	EA
PMHT-1472-38-HS-AL	Post mounted hutch with organizer	EA
DKT-72	Two flip-up doors for hutch	EA
TIL-1872-F-AL	Panel Insert 18"H	EA

2 WMHT-1436-14	Wall mount open hutch 14"D×36"W×14"H	EA
3 WMHT-1472-14	Wall mount open hutch 14"D×72"W×14"H	EA
4 DKT-72-HING	Four hinged doors for 72" hutch	EA

570 Call for more model & laminate selections. Freight charges may apply. Check online for the most current price.



Shown in **laminated finish BW Black Walnut**.
Chairs and accessories shown are not included.

LAMINATE FINISH COLOUR



A HDL® LEVELS SERIES TIERED WORKSTATIONS

Levels is a dynamic series that combines popular storage & desking solutions with modern, metal desking components. Fully integrated with HDL's popular Innovations series, this series is designer-friendly, built-to-last and completely customizable.

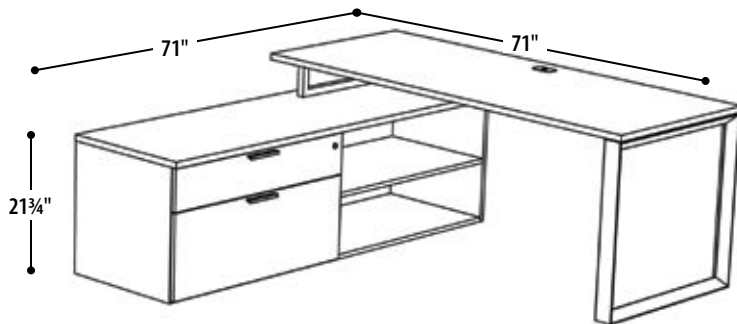

ORDER NUMBER	DESCRIPTION	UNIT
L-WORKSTATION 71"Wx71"Dx21¾"/29"		
1	LEV-LAYOUT1-LOOP-BWBWSBL BlackWalnut/Black	EA
HUTCH 71"Wx15¾"Dx42½"/35½"H		
2	LEV-TR4372MHHD-2-BWBL BlackWalnut/Black	EA
CABINET STORAGE 35½"Wx21¾"Dx64½"H		
3	LEV-SR6536TC-BWBL BlackWalnut/Black	EA



Shown in laminate finish NGL Noce Grigio

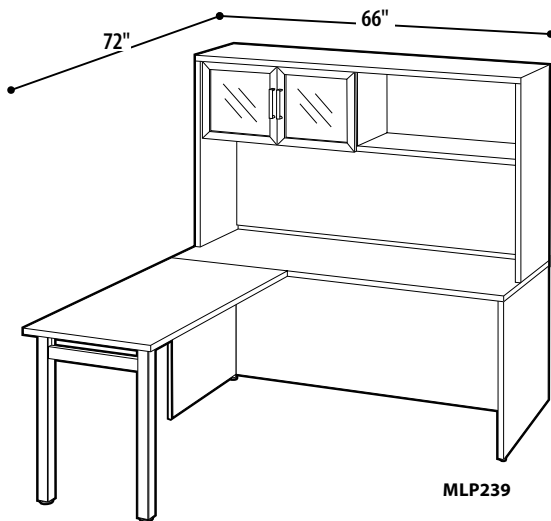

LAMINATE FINISH COLOURS



A OFFICES TO GO™ IONIC WORKSTATION DESK PACKAGE

Ionic is able to support a wide range of workspace applications. Start with the desk, hutch and return and then add on the cabinets you need. 66"W×72"D.

ORDER NUMBER	DESCRIPTION	UNIT
1 MLP239 NGL OG	Desk Package	EA

PACKAGE COMPONENTS

ML66H0	Hutch 66"W×15"D×36"H	EA
ML33DRAG	Glazed door set	EA
ML6624C	Credenza, rectangular 66"W×24"D×29"H	EA
ML4824RWL	Return with H leg 48"W×24"D	EA

B OFFICES TO GO™ IONIC CABINET PACKAGE

36"W×24"D

ORDER NUMBER	DESCRIPTION	UNIT
1 MLP240 NGL OG	Cabinet Package	EA

PACKAGE COMPONENTS

ML36H0	Hutch 36"W×15"D×36"H	EA
ML36PHGD	Glazed door set	EA
ML3624SLT	Open shelf, Lateral w/top 36"W×24"D	EA



C OFFICES TO GO™ IONIC MOBILE PEDESTAL

ORDER NUMBER	DESCRIPTION	UNIT
1 MLMP22BF NGL OG	16"W×22"D×23"H	EA



Shown in **laminated finish EZ Evening Zen**
Chair and accessories shown are not included.

LAMINATE FINISH COLOURS



A HDL® INNOVATIONS CLOSED HUTCH "L" WORKSTATION

Quality and flexibility with lasting durability. Tops, gables and modesty panels are thermally fused melamine on 45 lb. industrial particle board core. All exposed edges are finished in matching 2 mil PVC – tough and durable. Drawers are 5-piece construction with 1/2" black vinyl board sides. Full size corner layout with 4-door hutch, tackboard and optional glass doors 72" W x 72" D.

ORDER NUMBER	DESCRIPTION	UNIT
1 INV-LAYOUT-6A-EZ	Desk Package	EA

PACKAGE COMPONENTS

INV-3672CM	Left extended corner desk, 36" W x 24" D x 72" H	EA
INV-2436RSBR	Reversible left 36" W x 24" D return	EA
INV-HPF	Locking box/file pedestal	EA
INV-3672H	Open hutch 72" W x 15" D x 36" H	EA
INV-3672TB	Fabric tackboard (Black or Grey)	EA
INV-72HDRS	Four hinged door kit, laminate	EA

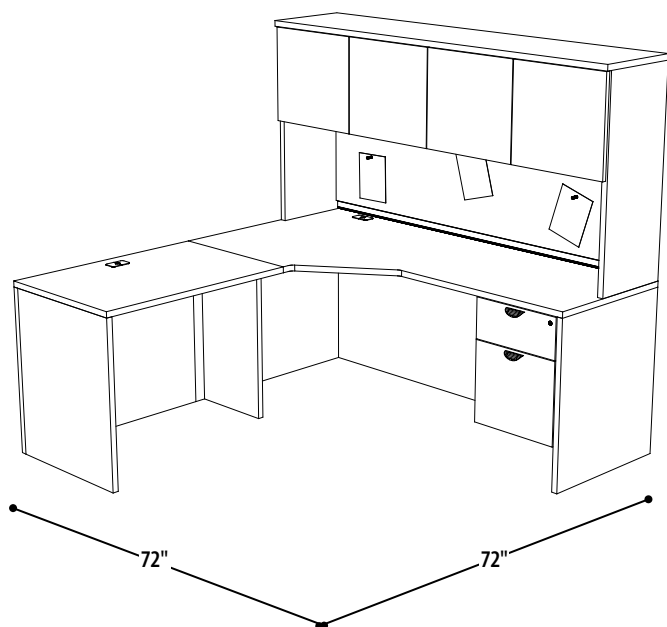

Call for more model & laminate selections. Freight charges may apply. Check online for the most current price. **573**



Shown in laminate finish ACJ Absolute Acajou
Chairs and accessories shown are not included.



LAMINATE FINISH COLOUR



OFFICES TO GO™ IONIC ELECTRIC HEIGHT ADJUSTABLE WORKSTATIONS

Quick assembly. Unfold leg columns, attach feet and worksurface support to base; fasten assembly to top; plug in connections and start to use. Range of adjustability with 1" thick top is 28.1" to 46.7"H. Easy to use up-down controller with digital read-out and four memory programmable positions. 265 lbs. lift capacity and anti-collision sensor. Operates at 1.2" per second.

A DESK, HUTCH AND HEIGHT ADJUSTABLE TABLE

ORDER NUMBER	DESCRIPTION	UNIT
1 ML7224C ACJ	72"W×24"D Credenza	EA
2 ML22HBF ACJ	Hanging box/file pedestal	EA
3 ML48242QHT ACJ TN	48"W×24"D Height adjustable table	EA
4 ML72HO ACJ	Open hutch	EA
5 ML36DRL ACJ	Laminate hutch doors	EA



B DESK AND HEIGHT ADJUSTABLE TABLE

ORDER NUMBER	DESCRIPTION	UNIT
1 ML7224C ACJ	72"W×24"D Credenza	EA
2 ML22HBF ACJ	Hanging box/file pedestal	EA
3 ML48242QHT ACJ TN	48"W×24"D Height adjustable table	EA

C TABLE WITH RETURN

ORDER NUMBER	DESCRIPTION	UNIT
1 ML60242QHT ACJ TN	60"W×24"D Primary top	EA
2 ML36242QHR ACJ TN	36"W×24"D Return top	EA

574 Call for more model & laminate selections. Freight charges may apply. Check online for the most current price.

LAMINATE FINISH COLOURS



OFFICES TO GO™ IONIC WORKSTATIONS

With its clean modern form, Ionic is able to support a wide range of workspace applications. From cubicles to multi-station clusters, private offices or reception areas. Ionic offers well designed practical desk solutions. Work surfaces feature a protective 3mm matching edge.



Shown in laminate finish ACJ Absolute Acajou

A OFFICES TO GO® IONIC SUPERVISOR SUITE

ORDER NUMBER	DESCRIPTION	UNIT
MLP106 ACJ AA	72" W×72" D	EA

PACKAGE COMPONENTS

ML72HO	Open hutch, 72" W×15" D×36" H	EA
ML36DRL	Hutch doors, 2 sets of 2	ST
ML7224C	Credenza, 72" W×24" D×29" H	EA
ML4824R	Return, 48" W×24" D×29" H	EA
ML22BBF	Box/box/file, 16" W×22" D×28" H	EA



Shown in laminate finish NGL Noce Grigio

B OFFICES TO GO® IONIC U-SHAPED SUITE

ORDER NUMBER	DESCRIPTION	UNIT
MLP229 NGL OG	72" W×96" D	EA

PACKAGE COMPONENTS

ML7230DWL	Table desk, 72" W×30" D×29" H	EA
ML4224B	Bridge, 42" W×24" D	EA
ML22BBF	Box/box/file, 16" W×22" D×28" H	EA
ML7224C	Credenza, 72" W×24" D×29" H	EA
ML72HO	Open hutch, 72" W×15" D×36" H	EA



Shown in laminate finish ACJ Absolute Acajou

C OFFICES TO GO® IONIC U-SHAPED SUITE

ORDER NUMBER	DESCRIPTION	UNIT
MLP228 ACJ AA	72" W×96" D	EA

PACKAGE COMPONENTS

ML7230DWL	Table desk, 72" W×30" D×29" H	EA
ML4224B	Bridge, 42" W×24" D	EA
ML7224C	Credenza shell, 72" W×24" D×29" H	EA
ML22HBF	Hanging box/file, 16" W×22" D×19" H	EA



Shown in laminate finish ACJ Absolute Acajou

D OFFICES TO GO® IONIC DESKS

ORDER NUMBER	DESCRIPTION	UNIT
MLP108 ACJ AA	66" W×78" D	EA

PACKAGE COMPONENTS

ML6630D	Desk, 66" W×30" D×29" H	EA
ML4824R	Return, 48" W×24" D×29" H	EA
ML22BBF	Box/box/file, 16" W×22" D×28" H	EA

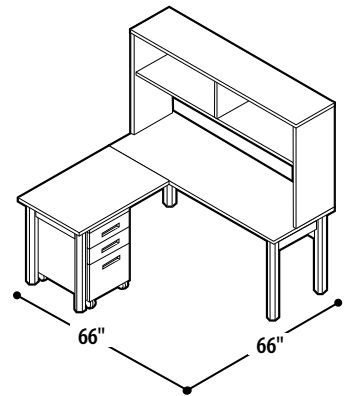

Shown in **laminated finish NGL Noce Grigio**.
Chairs and accessories shown are not included.



LAMINATE FINISH COLOURS



A OFFICES TO GO™ IONIC WORKSTATION

Features a clean modern form, able to accommodate small spaces. An open chassis allows for easy access to wall power and data.

ORDER NUMBER	DESCRIPTION	UNIT
1	MLP527 NGL OG "L" Shaped suite w/hutch	EA

PACKAGE COMPONENTS

ML6630DWL	66"×30" Table	EA
ML3624RWL	36"×24" Return	EA
ML66HO	Open hutch	EA
MLMP22BBF	Box/box/file mobile pedestal	EA
ML6612MPT	66"W Modesty panel	EA

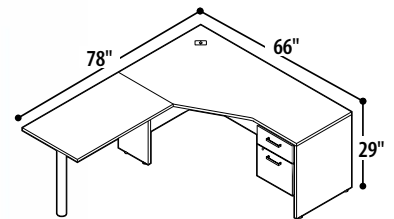

Shown in **laminated finish ACJ Absolute Acajou**



LAMINATE FINISH COLOURS



B OFFICES TO GO™ L-SHAPED SUITE

Ionic offers a range of mix and match components that can be easily configured to suit any office. Design details include thermally fused laminate surfaces, durable 2 mm PVC edge, leveling glides and superior hardware.

ORDER NUMBER	DESCRIPTION	UNIT
1	MLP115L ACJ AA Left hand return	EA
2	MLP115R ACJ AA Right hand return	EA
*change ML6636CEL to ML6636CER		

PACKAGE COMPONENTS

ML6636CEL*	66"W×36"D×29"H	EA
	Left extended corner credenza	
ML4224RI	42"W×24"D×29"H	EA
	Rectangular surface w/ post	
ML22HBF	16"W×22"D×19"H Hanging box/file pedestal	EA

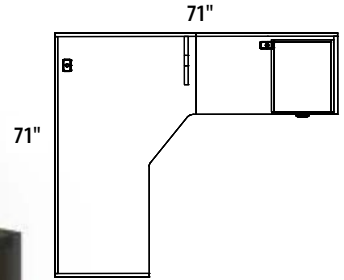

Shown in **laminated finish GD Grey Dusk**
Chairs and accessories shown are not included.



LAMINATE FINISH COLOUR



A HDL® INNOVATIONS L-WORKSTATION

Innovations has the designer edge and the flexibility needed in the modern workspace to accommodate individual needs. High quality construction with 1" thick commercial grade tops and durable 2 mm thick PVC edging. Includes levelling glides.

ORDER NUMBER	DESCRIPTION	UNIT
1 INV-LAYOUT-13B-GD	71"×71"	EA

PACKAGE COMPONENTS

INV-2436RSBR	Return shell	EA
INV-7236CM	Extended corner module	EA
INV-HPF	Hanging pedestal	EA

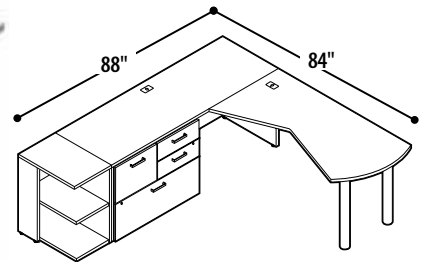

Shown in **laminated finish NGL Noce Grigio**
Chairs and accessories shown are not included.



LAMINATE FINISH COLOURS



B OFFICES TO GO™ IONIC L SHAPED DESK PACKAGE

With its clean modern form, Ionic supports a wide range of workspace applications. Ionic is built to last and is true commercial quality at an affordable price. Tested to meet BIFMA standards and is Greenguard certified.

ORDER NUMBER	DESCRIPTION	UNIT
MLP634 NGL OG	Ionic 84" W×88" D "L" shaped workstation	EA

PACKAGE COMPONENTS

ML6030PR	Delta island top, 60"×30"	EA
ML7224C	Rectangular credenza shell 72"×24"	EA
ML6012MP	Modesty panel, 45"×12"	EA
ML1629SHL	Open shelving unit, 16"W×24"D×29"H	EA
ML3622MS	Locking underdesk multi storage cabinet, 36"W×22"D×28"H	EA





Shown in **laminite finish WW Winter Wood**

LAMINATE FINISH COLOUR

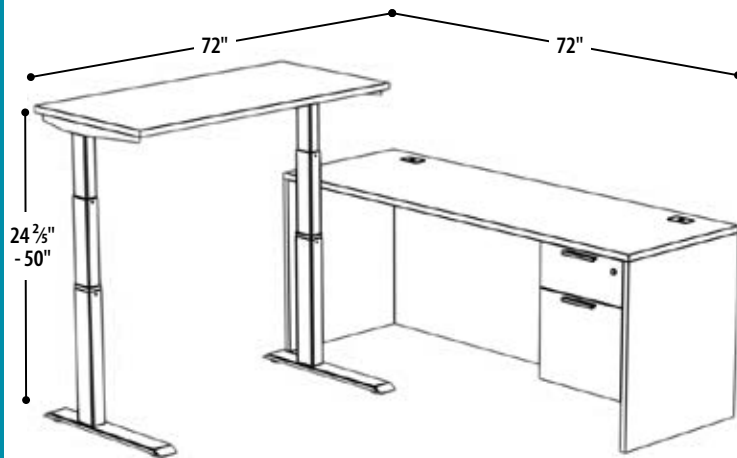

A HDL® INNOVATIONS SERIES HEIGHT ADJUSTABLE SUITE

Innovations has the designer edge and the flexibility needed in the modern workspace to accommodate individual needs. High quality construction with 1" thick commercial grade tops and durable 2 mm thick PVC edging. Height Adjustable L-Shape Suite. Configuration features a height-adjustable desk, fixed height credenza with box/file pedestal. Includes levelling glides. Desk height ranges from 24 7/8" to 50". Assembly not included. Limited Lifetime Warranty. Winter Wood finish.

ORDER NUMBER	DESCRIPTION	UNIT
1 INV-LAYOUT-46-WW	Suite	EA

PACKAGE COMPONENTS		
INV-HPF	Hanging Pedestal	EA
INV-2472SH	Credenza Shell	EA
INV-2448TOP	48" Top	EA
CAL-E1-2LEG	Calypso electric 2 leg base	EA



Shown in **laminated finish**
TW/NM True White and Nutmeg

LAMINATE FINISH COLOURS

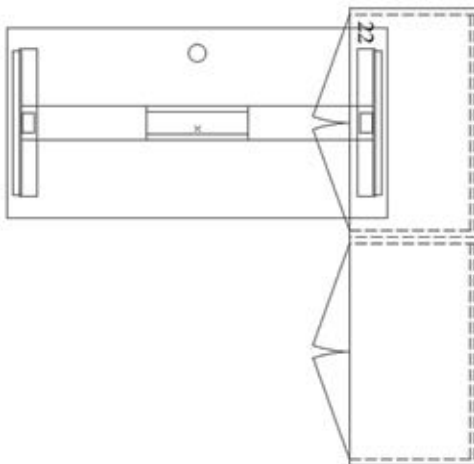

A LINKS ELECTRIC HEIGHT ADJUSTABLE WORKSTATION

It is healthy to change from a seated to a standing position regularly throughout the work day. Studies show the use of height adjustable worksurfaces can increase a users productivity. Features 4 programmable settings. UL/CSA approved. 225lb load capacity. Height range of 23"-49.5". Two storage cabinets. Left hand storage cabinet accessed from opposite side.

ORDER NUMBER	DESCRIPTION	UNIT
1	TBL-AHTB-DBL Height adjustable base, silver	EA
2	TOP-2448-OG 24"D×48"W, Worksurface	EA
3	TOP-2460-OG 24"D×60"W, Worksurface	EA
4	TOP-3048-OG 30"D×48"W, Worksurface	EA
5	TOP-3060-OG 30"D×60"W, Worksurface	EA
6	CAB-2072-22-SCSCOG-P Credenza, Nutmeg doors, 72"W×20"D×22"H	EA
7	ACC-2036 Seat cushion	EA

Workstations

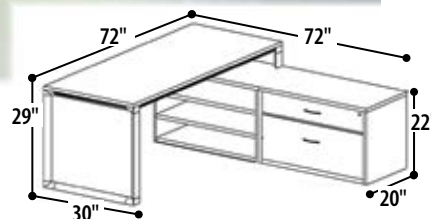

Shown in laminate finish TW True White/LB Lime Burst
Chairs and accessories shown are not included.

LAMINATE FINISH COLOURS



A LINKS BENCH TR115

Bench by Links is a creative fusion of stylish design and functional modularity. Freestanding benching system allows you to create many layouts with a minimum of modules. True White/Lime Burst. 72"W×72"D×29"H.

ORDER NUMBER	DESCRIPTION	UNIT
1 TR115-TW/LB	Workstation	EA
PACKAGE COMPONENTS		
TR1-3072-CF	Closed leg desk, floating one side	EA
CAB-2072-22-OSBF-P	Open shelf, box/file credenza	EA



Shown in laminate finish NM Nutmeg/TW True White

LAMINATE FINISH COLOURS

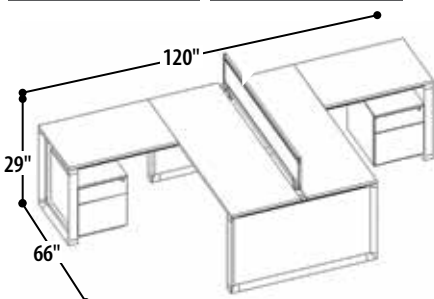

B LINKS BENCH TR120 DOUBLE PERSON WORKSTATION

Package consists of 2 freestanding desks, left return, right return, linear divider panel set, wire management tray and box/file, mobile pedestal. 120"W×66"D×29"H. Nutmeg/True White.

ORDER NUMBER	DESCRIPTION	UNIT
1 TR120-NM/TW	Workstation	EA
PACKAGE COMPONENTS		
TR2LR-2466-2436	Two 24"×66" Desks with 24"×36" returns	EA
TRPS-1260-F	Fabric panel	EA
ELE-TRWM-48	Wire trough	EA
CAB-1622-TMBF	Mobile box/file pedestal (2)	EA

580 Call for more model & laminate selections. Freight charges may apply. Check online for the most current price.

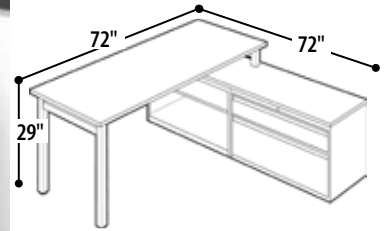

Shown in laminate finish NGL Noce Grigio/DW Designer White
Chairs and accessories shown are not included.

LAMINATE FINISH COLOURS



A OFFICES TO GO™ IONIC & MVL "L" WORKSTATION

A range of mix and match components that maximizes work space and storage in small spaces; overlapping 30"D laminate desk, 19"D steel based credenza with laminate sub top. Laminate horizontal surfaces, white painted steel storage with box/file drawer lateral and open shelf; 2"×2" square metal legs support laminate desk in tungsten. Some assembly required, may be assembled for left or right hand use.

ORDER NUMBER	DESCRIPTION	UNIT
1 MLP236 NGL DW TN	Workstation	EA

PACKAGE COMPONENTS

ML7230POL	30"D Desk, overlap w/legs	EA
M19361XSN	36"W 1½ Bookcase cabinet	EA
M1936PXBF	36"W 1½ Lateral cabinet	EA
ML7219LT	Finished top for storage	EA

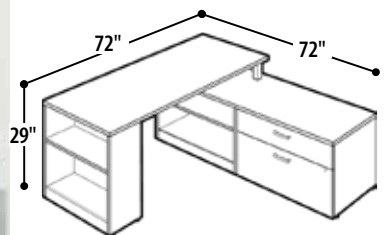

Shown in laminate finish ACJ Absolute Acajou/DW Designer White
Chairs and accessories shown are not included.

LAMINATE FINISH COLOURS



B OFFICES TO GO™ IONIC "L" WORKSTATION

Clean modern overlapping design with extensive storage. 72"×30"D desk supported on one end by 12"D bookcase, overlapping 24"D open shelf and box/file lateral combination in laminate case construction on the other end. Laminate horizontal surface. Bookcase, open shelf and box/file lateral all in white laminate. Some assembly required, may be assembled for left or right hand use.

ORDER NUMBER	DESCRIPTION	UNIT
1 MLP237 ACJ DW TN	Workstation	EA

PACKAGE COMPONENTS

ML7230POB	30"D Desk, overlap w/bookcase	EA
ML2136CO	Low shelf unit 24"D without top	EA
ML2136BF	Box/file drawer 24"D without top	EA
ML7224LT	Finished top for storage	EA



Shown in **laminated finish RM Riviera Maple/TW True White**
Chairs and accessories shown are not included. 3 stations shown. Priced per each.

LAMINATE FINISH COLOURS

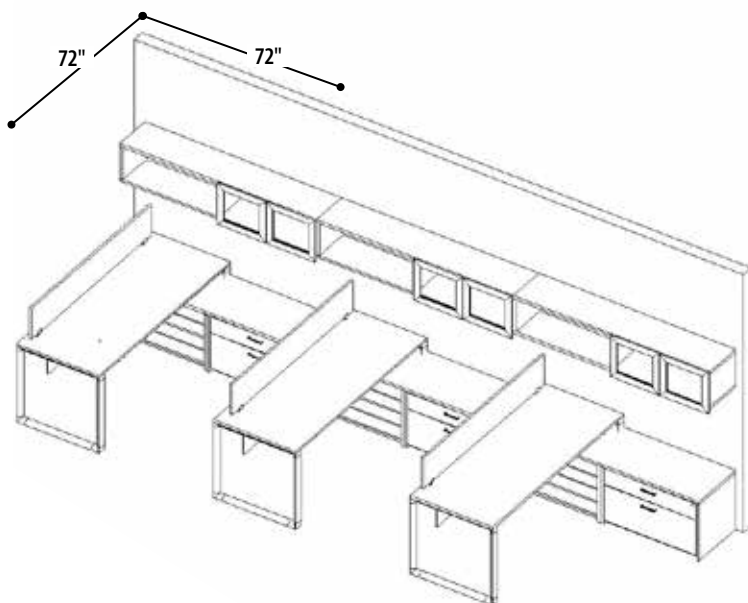

A LINKS® BENCH SOLO WORKSTATION

Create an atmosphere that encourages improved productivity and harmony. Design a setting that is active, airy, and beautiful. L-shaped Workstation, includes a closed leg desk with floating one side, open shelf, box/file credenza, wall mounted hutch and glazed door kit. Overall Dimensions: 72"W×72"D×29"H

ORDER NUMBER	DESCRIPTION	UNIT
1 TR-SOLO-TW/RM	Bench Solo workstation 24"W×72"D×30"H	EA

PACKAGE COMPONENTS

CAB-2072-22-OSBF-P	Open shelf, box/file credenza with 3 adjustable shelves, 72"×20"×22"H	EA
TR1-3072-CF	Bench desk (closed left) 30"D×72"W	EA
TRPS-1266-L-A	Divider panel set 66"W×12"H	EA
TR-MOD-54-L	Modesty panel, 48"×12"H	EA

2 WMHT-1472-14	Wall mount open hutch 14"×72"×14"H	EA
3 DKT-36-HING-WZ	Two glazed doors for 36" hutch	PR

582 Call for more model & laminate selections. Freight charges may apply. Check online for the most current price.

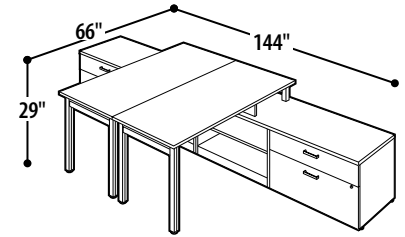

A OFFICES TO GO™ IONIC 2-PERSON WORKSTATIONS

Side by side workstations are ideal for encouraging collaboration. Ready to assemble. 144"W×66"D×29"H.

Shown in **laminite finish**
DWT Designer White/NGL Noce Grigio
Chairs and accessories shown are not included.



LAMINATE FINISH COLOURS



ORDER NUMBER	DESCRIPTION	UNIT
1 MLP234 DWT OG TN	Workstation	EA

PACKAGE COMPONENTS

ML6630POL	30" Desk, overlapping (2)	EA
ML2136CO	Open shelf unit (2)	EA
ML2136BF	Box/file lateral (2)	EA
ML7224LT	Top (2)	EA

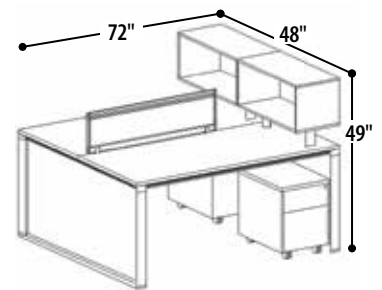

B LINKS BENCH TR225 DOUBLE PERSON WORKSTATION

Bench by Links is a creative fusion of stylish design, aesthetic and functional modularity. This freestanding benching system lends an unusual lightness while also being exceedingly practical for daily usage. Package consists of two person freestanding desk, hutch mounted on two 6" posts, fabric linear divider panel set, mobile pedestal, and box/file. 72"W×48"D×49"H.



Shown in **laminite finish**
CP Cappuccino/TW True White
Chairs and accessories shown are not included.

LAMINATE FINISH COLOURS



ORDER NUMBER	DESCRIPTION	UNIT
1 TR225-CP/TW	Workstation	EA

PACKAGE COMPONENTS

TR2-2472-G-C	Two person desk	EA
TRPH-1424-20	Post mounted hutch (2)	EA
TRPS-1248-F	Framed divider panel	EA
CAB-1622-LMBF	Mobile box/file pedestal (2)	EA

Workstations



Shown in laminate finish DWT Designer White/ACJ Absolute Acajou
Chairs and accessories shown are not included.

LAMINATE FINISH COLOURS



A

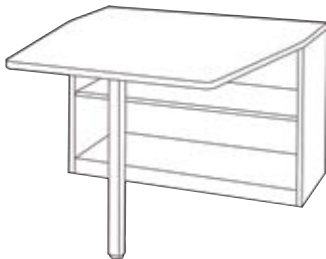

A OFFICES TO GO™ IONIC HUDDLE TABLE WITH STORAGE

Suitable to add-on in a private office, in-line in an open plan or stand alone in a small meeting space, Ionic huddle spaces support small group collaboration.

ORDER NUMBER	DESCRIPTION	UNIT
1 MLP319 DWT AA	36"W×60"D×29"H	EA

PACKAGE COMPONENTS

ML36290S	Open shelf storage	EA
ML3636WT	Huddle top wedge	EA
ML2SQLEG	Square post leg	EA

B



B OFFICES TO GO™ IONIC CREDENZA WITH STORAGE

Credenza storage package is sure to be the perfect backdrop for a height adjustable table or freestanding table desk.

ORDER NUMBER	DESCRIPTION	UNIT
1 MLP372 DWT AA	108"W×24"D×29"H	EA

PACKAGE COMPONENTS

ML7224C	Credenza	EA
ML22BBF	Box/box/file pedestal	EA
ML3624SCT	2 Door cabinet with top	EA

C



C OFFICES TO GO™ IONIC ELECTRIC HEIGHT ADJUSTABLE WORKSTATION

Quiet hex rod driven single motor base. Operates at 0.75" per second. Easy to use up-down controller with digital read-out and four memory programmable positions. 250 lbs. lift capacity. Height range from 28" to 45¼".

ORDER NUMBER	DESCRIPTION	UNIT
1 MLP318 DWT	70"W×58"W	EA

PACKAGE COMPONENTS

MLIR20B	Table base	EA
ML7023HAT	70"W×23"D Top	EA
MLIR20R	Return base	EA
ML3523RHT	35"W×23"D Return top	EA

LAMINATE FINISH COLOURS



D OFFICES TO GO™ IONIC MAKER TABLE

Bar height table for standing meetings or maker spaces. Features a 1" thick laminate top.

ORDER NUMBER	DESCRIPTION	UNIT
ML6030BHT NGL TN	60"W×30"D×42"H	EA



Shown in laminate finish NGL Noce Grigio

Desks – small office / home office

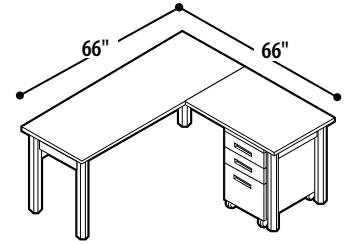

Shown in **laminated finish NGL Noce Grigio**
Chair and accessories shown are not included.

LAMINATE FINISH COLOURS



A OFFICES TO GO™ IONIC WORKSTATION

Ionic now offers open gable metal "H" legs and mobile pedestals that allow for smaller foot prints and a more contemporary look.

ORDER NUMBER	DESCRIPTION	UNIT
1 MLP231 NGL OG	"L" Shaped suite	EA

PACKAGE COMPONENTS

ML6630DWL	66"×30" Table	EA
ML3624RWL	36"×24" Return	EA
MLMP22BBF	Box/box/file mobile pedestal	EA
ML6612MPT	66"W Modesty Panel	EA

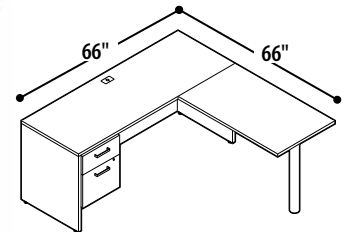

Shown in **laminated finish ACJ Absolute Acajou**



LAMINATE FINISH COLOURS



B OFFICES TO GO™ IONIC L SHAPED DESK PACKAGE

Clean modern form for a wide range of workspace applications. Ionic is built to last and is true commercial quality at an affordable price. Tested to meet BIFMA standards and Greenguard certified.

ORDER NUMBER	DESCRIPTION	UNIT
1 MLP113 ACJ AA	Ionic 66" W×66" D, "L" shaped workstation	EA

PACKAGE COMPONENTS

ML4224RI	Rectangular island, 42"×24"	EA
ML6624C	Rectangular credenza shell, 66"×24"	EA
ML22HBF	Locking box/file pedestal	EA

Call for more model & laminate selections. Freight charges may apply. Check online for the most current price. **585**

Desks – small office / home office



A OFFICES TO GO™ IONIC DESK WITH STORAGE

Ideal for working from home or small office spaces. Open pedestal with personal drawer. Non-locking. Absolute Acajou finish with Designer White base.

ORDER NUMBER	DESCRIPTION	UNIT
1 MLP304 ACJ DW TN	48" W×24" D×29" H	EA
2 MLP305 ACJ DW TN	54" W×24" D×29" H	EA
3 MLP306 ACJ DW TN	60" W×24" D×29" H	EA



Accessories shown are not included.

B HDL® RISE HEIGHT ADJUSTABLE DESK

Single motor, 2-leg height adjustable desk. ¾" laminate top. Features a 4-memory button handset. Slide-out drawer and USB charging port. 28½" to 48" height adjustment. 176 lb capacity. White.

ORDER NUMBER	DESCRIPTION	UNIT
RIS-E1-2LEG-WH	48" W×24" D×28½" to 48"H	EA



Shown in laminate finish WW Winter Wood



Shown in laminate finish NGL Noce Grigio
Chair and accessories shown are not included.

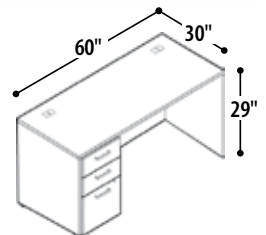

LAMINATE FINISH COLOUR

GD Grey Dusk	WW Winter Wood
--------------	----------------

LAMINATE FINISH COLOURS

ACJ Absolute Acajou	NGL Noce Grigio
---------------------	-----------------

C HDL® MIRA SINGLE PEDESTAL DESK

Commercial grade melamine woodgrain finish with 2mm PVC edging. Innovative floating top design with silver metal accents. Two-drawer pedestal.

ORDER NUMBER	DESCRIPTION	UNIT
1 MA-11-2448-GD	48" W×24" D×30" H	EA
2 MA-12-3060-WW	60" W×30" D×30" H	EA

D OFFICES TO GO™ RECTANGULAR DESK WITH FULL PEDESTAL

Features thermally fused laminate, 1" thick top and end gables, 2mm PVC matching edge, full height modesty panel and wire management grommets (2). The box/box/file pedestal features full extension slides.

ORDER NUMBER	DESCRIPTION	UNIT
MLP232 NGL OG	60" W×30" D	EA

586 Call for more model & laminate selections. Freight charges may apply. Check online for the most current price.

Desks – small office / home office

NEW!



Shown in laminate finish Noce Grigio



Shown in laminate finish NGL Noce Grigio
Chair and accessories shown are not included.



A OFFICES TO GO® PASHLEY MID CENTURY MODERN TABLE DESKS

Simple table desk or small meeting table with angled metal legs. 1" thick thermally fused laminate top with matching 2mm PVC edge for durability. Noce Grigio top with White base.

ORDER NUMBER	DESCRIPTION	UNIT
1 ML48240GD NGL	48" W×24" D×29½" H	EA
2 ML60300GD NGL	60" W×30" D×29½" H	EA
3 ML72300GD NGL	72" W×30" D×29½" H	EA

LAMINATE FINISH COLOURS



B OFFICES TO GO™ IONIC SINGLE PEDESTAL DESK

Clean modern form. Thermally fused 1" thick laminate work surface with matching 2mm PVC edging for durability. Drawers can be mounted on either side. Assembly not included.

ORDER NUMBER	DESCRIPTION	UNIT
MLP111 NGL OG	60" W×30" D×29" H	EA



Shown in laminate finish ACJ Absolute Acajou



LAMINATE FINISH COLOURS



Shown in laminate finish GD Grey Dusk



LAMINATE FINISH COLOUR



C OFFICES TO GO™ IONIC TABLE DESKS

Quick and easy assembly. Features an open frame with 2" H-legs with levelers. Thermally fused laminate desk with PVC matching edge and metal legs.

ORDER NUMBER	DESCRIPTION	UNIT
ML4824 DWL ACJ TN	48" W×24" D×29" H	EA

D HDL® SOHO TABLE DESK WITH LOOP LEGS

Quick assembly table desk. Features thermally fused laminate top with durable 2mm matching edge, and Loop legs. Hardware included. Ready to assemble.

ORDER NUMBER	DESCRIPTION	UNIT
TBL-2448-LOOP-SL-GD	48" W×24" D×29" H	EA

Call for more model & laminate selections. Freight charges may apply. Check online for the most current price. **587**

Reception suites



Shown in **laminated finish NGL Noce Grigio**.
Chairs and accessories shown are not included.



LAMINATE FINISH COLOURS



A OFFICES TO GO™ IONIC RECEPTION SUITE

This clean, modern design supports a wide range of workspace applications, from cubicles to boardrooms. All drawers have ball bearing over-travel slides. Accented by silver coloured handles and locks and 2 mm edging with black accent line. Desk features a translucent glass panel with a fluorescent light and a pigeon hole organizer; transaction unit has two shelves.

ORDER NUMBER	DESCRIPTION	UNIT
1	MLP633 NGL OG Reception suite	EA

PACKAGE COMPONENTS

ML72MRD	Modern reception desk, EA	72" W×36½" D×42" H
ML4824R	Reversible return shell, EA	48" W×24" D×29" H
ML36RT	Reception transaction top, EA	36" W×13" D×17" H

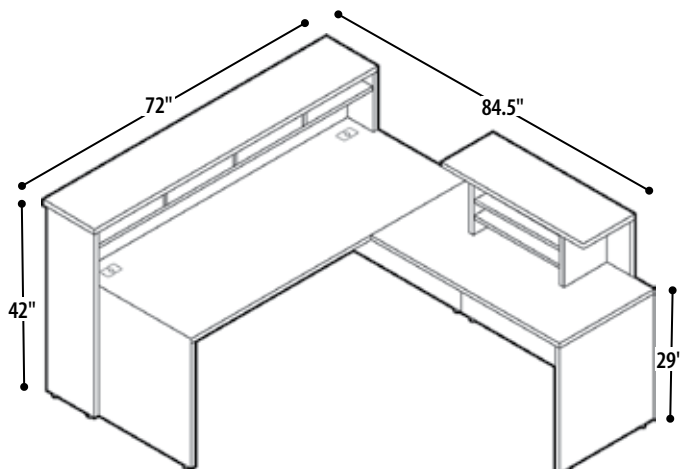

588 Call for more model & laminate selections. Freight charges may apply. Check online for the most current price.



Shown in **laminite finish Cappuccino/Willow Grey, CP/WG**
Accessories shown are not included.

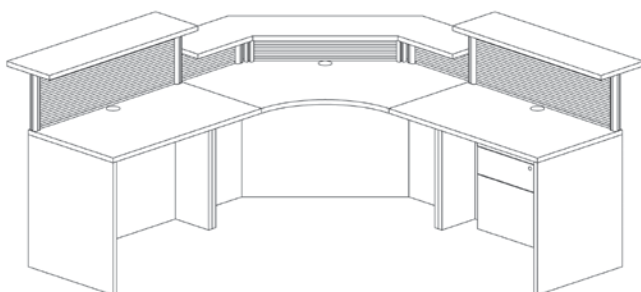
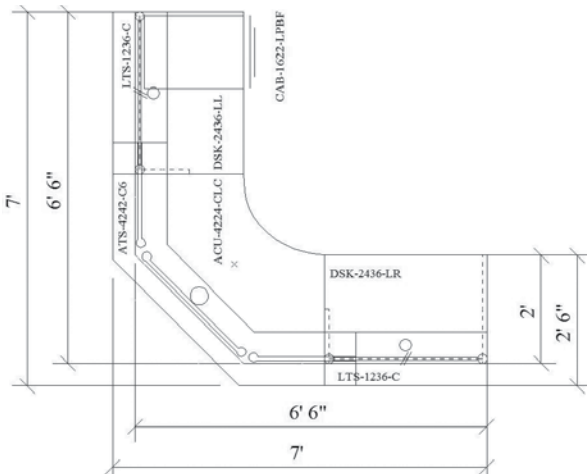

LAMINATE FINISH COLOUR



A LINKS® RECEPTION GALLERY

Reception Gallery offers an intelligent and effective solution for office entrance area. Manufactured with 1" thick surfaces, drop center counter, one box/file pedestal. Space required is 84"×84". Call for more size, colour and configuration options.

ORDER NUMBER	DESCRIPTION	UNIT
1 PS655-CP/WG	Reception gallery	EA

PACKAGE COMPONENTS

ACU-4224-CLC	Angled corner unit, 42"D×42"W	EA
DSK-2436-LR	Freestanding work table, Right 24"D×36"W	EA
DSK-2436-LL	Freestanding work table, Left 24"D×36"W	EA
CAB-1622-LPBF	Fixed pedestal Box/File 22"D×16"W	EA
LTS-1236-C	Linear transaction set, Crystal divider 36"W×12"H (2)	EA
ATS-4242-C6	Angled corner transactions set, Crystal, 42"×42"×6"H	EA

manufacturers website www.linkscontract.com

Call for more model & laminate selections. Freight charges may apply. Check online for the most current price. **589**

Reception suites



Shown in **laminite finish White and Evening Zen**
Chairs and accessories shown are not included.

LAMINATE FINISH COLOUR

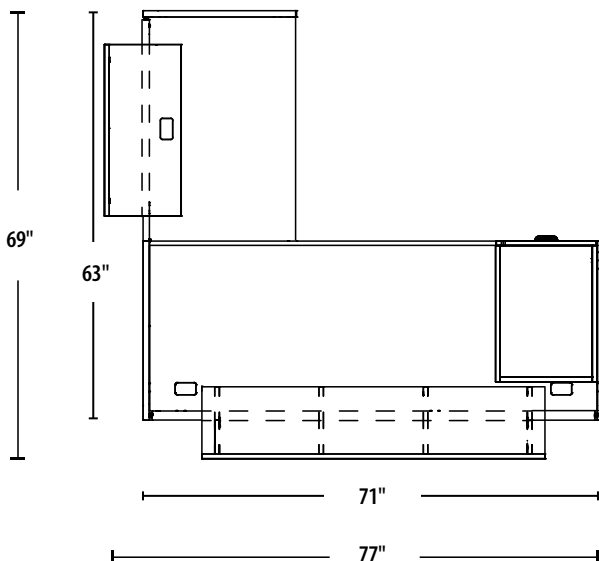

A HDL® INNOVATIONS CONTEMPORARY RECEPTION SUITE

Innovations has the designer edge and the flexibility needed in the modern workspace to accommodate individual needs. High quality construction with 1" thick commercial grade tops and durable 2 mm thick PVC edging. Includes levelling glides. White with Evening Zen. 69"×77"

ORDER NUMBER	DESCRIPTION	UNIT
1 INV-LAYOUT-19-EZ	Reception suite	EA

PACKAGE COMPONENTS

INV-3072GDS3	Modern reception desk	EA
INV-2436GRS3	Desk return	EA
INV-HPF	Hanging Pedestal	EA



Shown in Asian Night/Clear Maple ASN/CMB
Accessories shown are not included.

LAMINATE FINISH
COLOUR

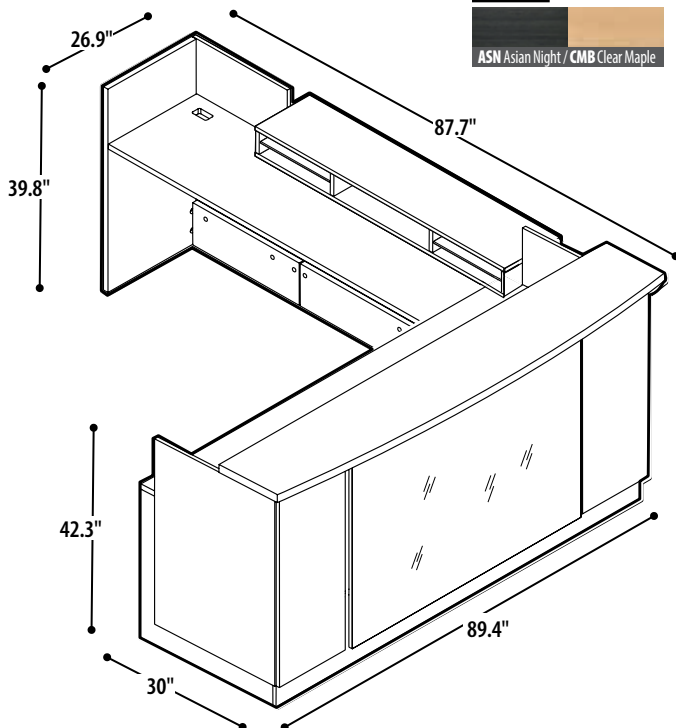

A GLOBAL™ ZIRA RECEPTION DESK

Zira is a contemporary desking solution with extensive options to personalize your workspace. For reception areas, create a work environment that meets your needs — then go ahead and personalize it! Components can be freestanding or joined together to form multiple solutions.

ORDER NUMBER	DESCRIPTION	UNIT
1 ZIRA403L CMB A3 AI BCZ1 HV	Reception desk	EA

PACKAGE COMPONENTS

Z2484RDB CMB A3 AI Z1	Reception desk w/bow top, Asian Night/Clear Maple 89.4"W×30"D×42.3"H	EA
Z2054PRRL CMB AI BC	Pigeon reception return, Asian Night/Clear Maple 57.7"W×26.9"D×39.8"H	EA
Z16L2BFS AI HV	Box Box File shell, Asian Night 16"W×23.4"D×28"H	EA
2 Z20M7ESHR ASN A3 AI	4 Shelf end shelf, Asian Night 20"W×20"D×72"H	EA
3 Z30M7BFCL ASN A3 AI 3T Z1 HV	Personal tower, Asian Night 30"W×20"D×71½"H	EA
4 Z36M73FN ASN A3 AI HV	Storage cabinet, Asian Night 36"W×20"D×71½"H	EA
5 Z16M7SHCL ASN A3 AI Z1 HV	Storage cabinet, left, Asian Night 16"W×20"D×71½"H	EA



Shown in **laminated finish GD Grey Dusk**
Chairs and accessories shown are not included.

LAMINATE FINISH COLOUR



GD Grey Dusk

77"

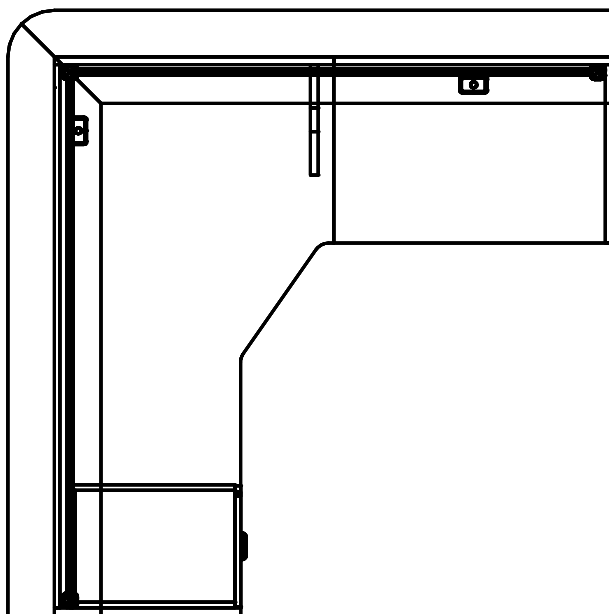

77"

A HDL® INNOVATIONS SERIES RECEPTION SUITE

Innovations has the designer edge and the flexibility needed in the modern workspace to accommodate individual needs. High quality construction with 1" thick commercial grade tops and durable 2 mm thick PVC edging. Includes levelling glides. 77"×77".

ORDER NUMBER	DESCRIPTION	UNIT
1 INV-LAYOUT-15B-GD	Reception suite	EA

PACKAGE COMPONENTS

INV-7236CM	Extended corner module	EA
INV-HPF	Hanging pedestal	EA
INV-2436RSBR	Return shell	EA
OUT-12POST	Post package (3)	EA
OUT-1272PYP	Polycarbonate panel (2)	EA
OUT-INV7272CTA	Corner transaction top	EA

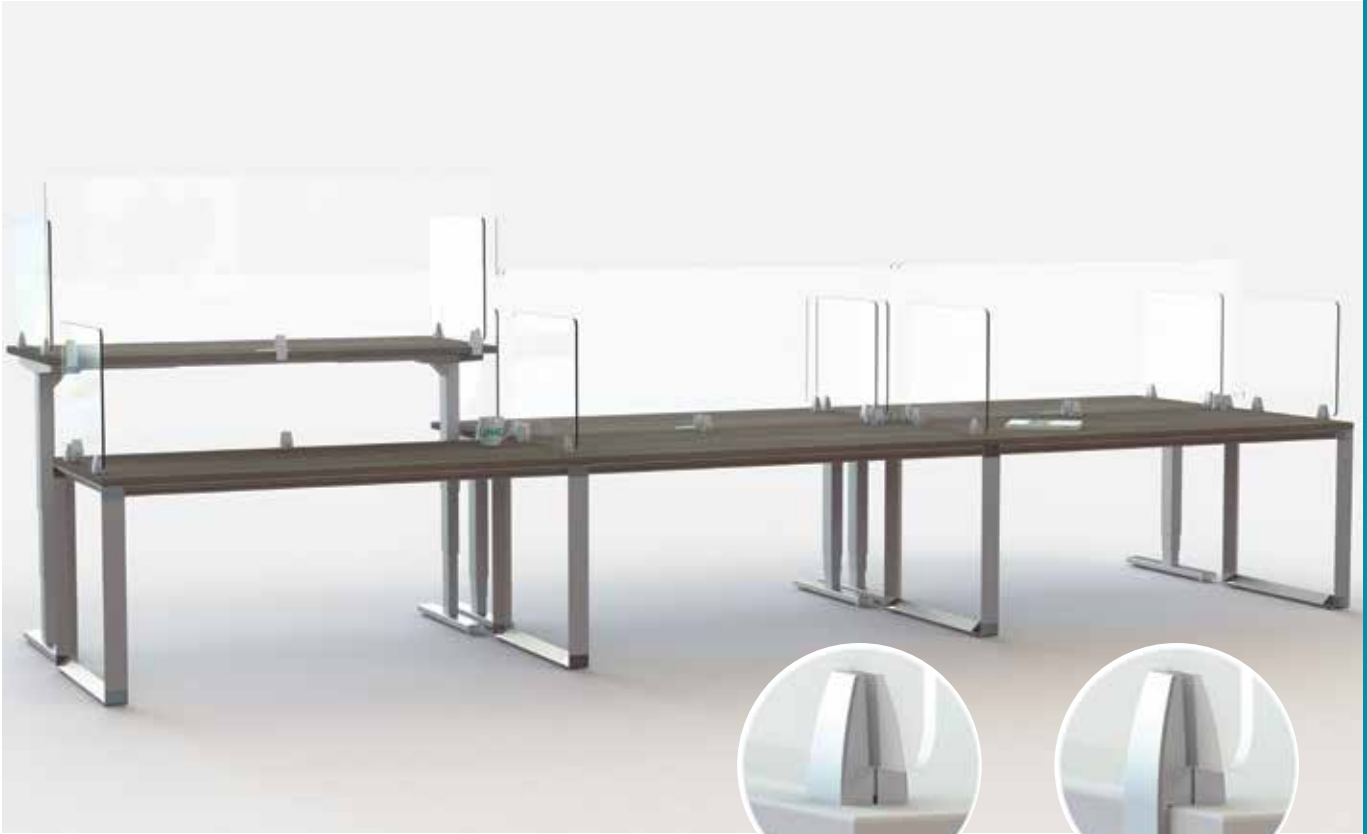

Ready to Assemble



A LINKS CLEAR PRIVACY PANELS

Surface mounted panels provide an easy installation to existing workstations, providing additional safety with no obstruction to normal daily workflow. 6mm acrylic panel with rounded corners. Silver brackets.

ORDER NUMBER	DESCRIPTION	UNIT
TOP MOUNT		
1	PIL-2424-XT	24"W×24"H
2	PIL-2430-XT	30"W×24"H
3	PIL-2436-XT	36"W×24"H
4	PIL-2442-XT	42"W×24"H
5	PIL-2448-XT	48"W×24"H
6	PIL-2454-XT	54"W×24"H
7	PIL-2460-XT	60"W×24"H
8	PIL-2466-XT	66"W×24"H
9	PIL-2472-XT	72"W×24"H
CLAMP MOUNT		
10	PIL-2424-XC	24"W×24"H
11	PIL-2430-XC	30"W×24"H
12	PIL-2436-XC	36"W×24"H
13	PIL-2442-XC	42"W×24"H
14	PIL-2448-XC	48"W×24"H
15	PIL-2454-XC	54"W×24"H
16	PIL-2460-XC	60"W×24"H
17	PIL-2466-XC	66"W×24"H
18	PIL-2472-XC	72"W×24"H

Privacy Panels



Shown in finish Grey/Charcoal
Chair, desk and accessories shown are not included.



A HDL® FRAMEWORKS WALL PANEL SYSTEM

Compact cubicle perfect for telemarketing and call centre applications. Acoustically designed to provide effective sound control. Tackable panel areas above the work surface. Simple click together installation is easily expandable.

ORDER NUMBER	DESCRIPTION	UNIT
1	FRM-LAYOUT-6 72"×72" Cubicle panels	EA
2	FRM-OSC36 Overhead storage	EA
3	FRM-OS36 Overhead shelf	EA
4	FRM-LAYOUT-4A 48"×42" Cubicle panels	EA
5	FRM-LAYOUT-4B Add-on 48"×42" cubicle	EA



B QUARTET® MOBILE ROOM DIVIDER

Minimize interaction and create privacy at your workstation. Metal frame sits on wheels for easy transportation. Wheels lock for stationary use. Plastic surface is easy to clean. 48"W×72"H. Clear and Black.

ORDER NUMBER	UNIT
HW200036	EA



C QUARTET® PRIVACY SCREEN

Lightweight and durable, a full length cubicle privacy screen lets co-workers know you are not to be disturbed. Wheeled screen rolls into place; attached whiteboard lets co-workers leave messages. Full length workstation privacy screen transforms cubicles into an interruption-free work zone. Shatterproof, polycarbonate material is translucent, allowing natural light to shine through. For cubicles up to 65"H; includes leg extenders for cubicles over 68" tall. Includes attachable whiteboard with built-in marker tray and nameplate. Screen: 38"W×64"H covers approx. 30"W opening.

ORDER NUMBER	UNIT
WPS2000	EA

Chair, desk and accessories shown are not included.

594 Call for more model & laminate selections. Freight charges may apply. Check online for the most current price.

Privacy Panels



PANEL FABRIC COLOUR

LL11 Med Taupe



Shown in **Lola Blue Mist LL14**
Accessories shown are not included.

A OFFICES TO GO™ IONIC PRIVACY PANELS

Create efficient workspace surround and freestanding or mobile dividers. Sleek simple aesthetic only 1 1/8" thick overall. Self-levelling connectors accommodate any angle. Rased bottom of 6 1/4" for ease of cleaning. Taupe with Tungsten frame.

ORDER NUMBER	DESCRIPTION	UNIT
1 ML6636 FFP LL11 TN	66"H×36"W	EA
2 ML6648 FFP LL11 TN	66"H×48"W	EA
3 ML6660 FFP LL11 TN	66"H×60"W	EA

B OFFICES TO GO™ IONIC PANEL CONNECTORS

Tungsten finish.

ORDER NUMBER	DESCRIPTION	UNIT
--------------	-------------	------

UNIVERSAL CONNECTOR KIT

One kit required for every 2 panels being connected. Any angle, straight, 90 degree, 3-way, 4-way or 120 degree.

1 MLPCHK	Universal Connector Kit	EA
----------	-------------------------	----

OFF MODULE CONNECTOR

Connect two panels off module creating a T configuration anywhere mid span. Attached to top and bottom vertical of one panel, then to top and bottom rail of adjacent panel.

2 MLOMCP TN	Universal Connector Kit	EA
-------------	-------------------------	----

C OFFICES TO GO™ IONIC PANEL FEET

Create a mobile or freestanding divider. Casters have a locking feature. Two required per panel.

ORDER NUMBER	DESCRIPTION	UNIT
1 MLSFFKP TN	Single Flat Foot	EA
2 MLSCFKP TN	Single Mobile Foot	EA
3 MLDFFKP TN	Flat Feet	2/PK
4 MLDCFKP TN	Mobile Feet	2/PK

D OFFICES TO GO™ IONIC PANEL WALL BRACKET

Bolts to ionic panel vertical in place of the standard hinge connector. Keyhole openings to slide over fasteners. Tungsten.

ORDER NUMBER	DESCRIPTION	UNIT
MLPPWA TN	Single Flat Foot	EA



Call for more model & laminate selections. Freight charges may apply. Check online for the most current price. **595**

Bookcases and Cabinets

Shown in laminate finish
WW Winter Wood

Shown in laminate finish
GD Grey Dusk

Shown in laminate finish
EZ Evening Zen



LAMINATE FINISH COLOURS



A HDL® INNOVATIONS BOOKCASES

Matching bookcase complements all Innovations Series office suites and is designed to align with the top of hutches. Features commercial grade 1" thick shelves. 45lb particle board core with thermally fused laminate finish and durable 3mm thick PVC edging. 32" Wide. Ready to assemble.

ORDER NUMBER	DESCRIPTION	UNIT
1 INV-4832BK-__	3-Shelf, 48"H	EA
2 INV-6532BK-__	4-Shelf, 65"H	EA
3 INV-7232BK-__	5-Shelf, 72"H	EA

Accessories shown are not included.

LAMINATE FINISH COLOURS



LAMINATE FINISH COLOURS

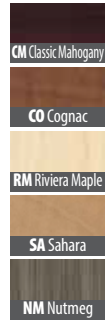

C LINKS® VERTICAL STORAGE CABINET AND BOOKCASE

Bookcase/storage cabinet with three, 1" thick, adjustable bookcase shelves – two above and one inside storage cabinet. 3mm edging and finished matching backs. Specify finish.



Shown in laminate finish
NM Nutmeg

B HDL® INNOVATIONS BOOKCASE DOOR KIT

Fits all Innovations bookcase sizes. The 65" and 72" bookcases will fit two. Kit includes soft close hinges, hardware and lock.

ORDER NUMBER	DESCRIPTION	UNIT
INV-32BKDRS-__	32" W×32" H	EA

ORDER NUMBER	DESCRIPTION	UNIT
BKC-123672-SCBC-P5 __	36" W×12" D×72" H	EA

596 Call for more model & laminate selections. Freight charges may apply. Check online for the most current price.

Bookcases and Cabinets



Shown in laminate finish
ACJ Absolute Acajou

LAMINATE FINISH COLOURS



A OFFICES TO GO™ IONIC BOOKCASES

Superior durability to withstand even the most rigorous environments. Ready to assemble. 30"W×12"D. Specify laminate finish.

ORDER NUMBER	DESCRIPTION	UNIT
1 ML48BC	48"H, 3 adjustable shelves	EA
2 ML65BC	65"H, 1 fixed, 3 adjustable shelves	EA



Shown in laminate finish
ACJ Absolute Acajou

LAMINATE FINISH COLOURS



B OFFICES TO GO™ IONIC CABINETS

Thermally fused laminate. 1" thick top and end gables. 3mm PVC matching edge. Adjustable floor leveling glides. Comes fully assembled. 36"W×24"D×28"H. Specify laminate finish.

ORDER NUMBER	DESCRIPTION	UNIT
1 ML3624LFT	Lateral file	EA
2 ML3624SCT	Storage cabinet	EA
3 ML3624MST	Multi-storage unit	EA



Accessories shown are not included.



FILE/STORAGE COLOURS



C GLOBAL™ STEEL BOOKCASES

Colours: **BLK** Black, **DWT** Designer White, **GRY** Grey. Specify colour.

ORDER NUMBER	DESCRIPTION	UNIT
1 93BC-3648-	36"×48", 3 adjustable shelves	EA
2 93BC-3672-	36"×72", 5 adjustable shelves	EA

Call for more model & laminate selections. Freight charges may apply. Check online for the most current price. **597**

Coat Racks



A SAFCO® NAIL HEAD COAT HOOKS

Satin aluminum hooks with matching back plate. Rounded nail head design protects garments while holding them securely in place. Mounting screws included. Greenguard certified.

ORDER NUMBER	DESCRIPTION	UNIT
1 4200	2-hook, 12"W×2¾"D×2"H	EA
2 4201	3-hook, 18"W×2¾"D×2"H	EA
3 4202	6-hook, 36"W×2¾"D×2"H	EA



B SAFCO® ONYX™ MESH WALL RACK COAT HOOK

Grid design for aesthetics. Five hooks. Steel construction. Black finish. Greenguard certified.

ORDER NUMBER	DESCRIPTION	UNIT
6403BL	26¾"W×3"D×5½"H	EA



C MERANGUE® DESK GROMMET

Handy cable management accessory, gathers electronic equipment cables to pass through the desktop. Diameter: 2¾" (70 mm); Black.

ORDER NUMBER	UNIT
1020-8431-20-000	EA



D SAFCO® COAT RACK WITH UMBRELLA STAND

Free-standing rack with four, double ball-tipped hooks holds up to eight garments. Greenguard certified. With umbrella stand: 21"W×70"H.

ORDER NUMBER	DESCRIPTION	UNIT
4168BL	Black	EA



E SAFCO® HOOK HEAD COAT RACK

Eight hooked arms with rounded edges. Tubular steel construction with scratch resistant finish. 15" diameter steel plate base offers superior stability. 15"Dia.×68"H.

ORDER NUMBER	DESCRIPTION	UNIT
4241BL	Black	EA



F SAFCO® COAT TREE

Metal coat tree with 15" base. Greenguard certified.

ORDER NUMBER	DESCRIPTION	UNIT
4191NC	Black	EA

598 Call for more model & laminate selections. Freight charges may apply. Check online for the most current price.



A STAR SUBRA SERIES MACHINE CABINET WITH SUPPLIES ORGANIZER AND STORAGE

Constructed of melamine laminate on a commercial grade composite wood core. Pigeonhole compartments keep various size paper and filing supplies organized. Fully enclosed lower storage compartment. Front casters lock.



ORDER NUMBER	DESCRIPTION	UNIT
SA84-3220GY	Grey, 32" W×20" D×29" H	EA



B STAR SUBRA SERIES COMPACT ADJUSTABLE HEIGHT EQUIPMENT CART

The framework of this heavy cart is heavy gauge steel tubing reinforced at each level. Formed metal lower shelf and back panel, with composite wood upper shelves finished in durable PVC laminate. Front locking casters.



ORDER NUMBER	DESCRIPTION	UNIT
SA80-2323GY	Grey, 17½" W×17½" D×23½-35½" H	EA



C SAFCO® WIRE MACHINE STAND

Steel frame and powder-coat finish for durability. Features two sturdy shelves. Four swivel casters with two locking. Black melamine top. Assembly not included. Black.



ORDER NUMBER	DESCRIPTION	UNIT
5207BL	24" W×20" D×27" H	EA



D SAFCO® SCOOT™ PRINTER STANDS

Mobile printer stands with two locking casters. Black powder coated steel with silver leg accents and black laminate top. Available in underdesk and deskside versions.



ORDER NUMBER	DESCRIPTION	UNIT
1 1855BL	Underdesk, 20¼" W×16½" D×14½" H	EA
2 1856BL	Deskside, 26½" W×20½" D×26½" H	EA

SAFCO® FEATURE



E SAFCO® WIRE DESK

Features one sturdy, adjustable shelf. Black steel frame and powder-coat finish for durability. Black melamine top. Four swivel casters with two locking, and four floor glides included. Assembly not included. Black.

ORDER NUMBER	DESCRIPTION	UNIT
5203BL	38" W×25" D×30" H	EA



Accessories shown are not included.

Call for more model & laminate selections. Freight charges may apply. Check online for the most current price. **599**

Boardroom Furniture



Shown in **laminite finish DES Dark Espresso**
Chairs and accessories shown are not included.



LAMINATE FINISH COLOUR



A GLOBAL™ ZIRA™ BOARDROOM FURNITURE

An extension of the Zira™ desking line, these models feature boardroom tables with 1.5" thick tops and bases that are equipped with hinged doors to manage hidden wires. Optional power/data grommets may be specified in the surface. The coordinating lectern and carts complete the package.

ORDER NUMBER	DESCRIPTION	UNIT
1 Z48120BE DES C3 DE BC	Boardroom table, 120"W×48"D×29½"H	EA
2 Z2444LEC DES A3 DE BC	Lectern, 24"W×18"D×44"H	EA
3 Z2822MCE DES A3 DE BC	Multimedia cart, 28"W×22¼"D×29½"H	EA
4 Z361836KD DES SI Z1 HV	Serving cart, 36"W×18"D×36"H	EA
5 Z261836BK DES DE SI	Buffet cart, 26"W×18"D×36"H	EA

600 Call for more model & laminate selections. Freight charges may apply. Check online for the most current price.



Chairs and accessories shown are not included.



LAMINATE FINISH COLOURS

DWT Designer White	ASN Asian Night
--------------------	-----------------

A OFFICES TO GO™ IONIC SERIES

The clean, modern design of Ionic supports a wide range of workspace applications, from cubicles to boardrooms. All drawers have ball bearing over-travel slides. Accented by 3 mm matching edge with black accent line, silver colour handles and locks. Ready to assemble.

ORDER NUMBER	DESCRIPTION	UNIT
1 ML120BT ASN DW	Boat shaped, conference table, 120"W×48"D×29"H	EA
2 ML36H0 ASN	Open hutch, 36"W×15"L×36"H	EA
3 ML3624SCT ASN DW	Storage cabinet, with doors 36"W×24"L×29"H	EA
4 ML7224LT ASN	Shared top for lateral storage, 72"W×24"D×1"H	EA
5 ML3622SL DWT	Open shelf lateral storage with drawer, 36"W×22"L×28"H	EA



Chairs shown are not included.

LAMINATE FINISH COLOUR

EZ Evening Zen

B HDL® INNOVATIONS EXPANDABLE BOARDROOM TABLE

High quality construction with 1" thick commercial grade tops and durable 3 mm thick PVC edging. Seats 6 to 8 people and features wire management grommets. Includes levelling guides. Table shown includes the 96" top and base. It can be easily expanded in increments of 48" by adding the extension top and base up to 24 feet long!

ORDER NUMBER	DESCRIPTION	UNIT
1 INV-RTE9648-EZ	Table top, 96"×48"	EA
2 INV-PSE96-EZ	Table base	EA
3 INV-SQ48-EZ	Extension top, 48"×48"	EA
4 INV-PSE48-EZ	Extension base	EA

Tables



Meeting table configuration



Conference table configuration



Educational/training configuration



Trapezoid table configuration

Chairs and accessories shown are not included.

LAMINATE FINISH COLOURS

FM Figured Mahogany	GR Grey	HC Henna Cherry	WW Winter Wood
----------------------------	----------------	------------------------	-----------------------



Folding tables nest together



Easy to use folding lever



Joining plates to connect quarter round table tops without using table bases.



Thumb screws allow ganging connections

A STAR TUCANA CONFERENCE ROOM TABLES

Flexible, convenient and affordable table system that can be used freestanding or in linked combinations. Bases and tops are sold separately for added flexibility and customization. Tables fold and nest together for storage; locking heavy duty casters provide mobility. Commercial grade construction features heavy duty welded metal bases and 1" laminated tops that are water, scratch and dent resistant, with rubberized protective molding. Ganging clips allow quick connection of tables. Modesty panels in bases feature access grommets and wire troughs for cable management. Ready to assemble. Table top laminate colours: **FM** Figured Mahogany, **GR** Grey, **HC** Henna Cherry, or **WW** Winter Wood; specify colour.

ORDER NUMBER	DESCRIPTION	UNIT
1 TU97R-3624-	Rectangular table top, 36" W×24" D	EA
2 TU97R-6024-	Rectangular table top, 60" W×24" D	EA
3 TU97R-7224-	Rectangular table top, 72" W×24" D	EA
4 TU97H-4824-	Half round table top, 48" W×24" D	EA
5 TU97Q-3030-	Quarter round table top, 30" W×30" D	EA
6 TU97T-4824-	Trapezoid, 48" W×24" D	EA
7 TU99-3030ME	Joining plate kit for quarter round top	EA
8 TU97L-1520ME	Table base for 30" top	EA
9 TU97L-2420ME	Table base for 36" and 48" tops	EA
10 TU97L-7220ME	Table base for 60" and 72" tops	EA

602 Call for more model & laminate selections. Freight charges may apply. Check online for the most current price.



LAMINATE FINISH COLOUR

ASN Asian Night



A OFFICES TO GO™ IONIC TRAINING TABLE

Flip top tables allow for easy storage and nesting. Laminate top with Tungsten modesty panel and legs. Locking casters. Assembly not included. Asian Night finish.

ORDER NUMBER	DESCRIPTION	UNIT
1 ML4824FT ASN TN	48"W×24"D	EA
2 ML6024FT ASN TN	60"W×24"D	EA
3 ML7224FT ASN TN	72"W×24"D	EA

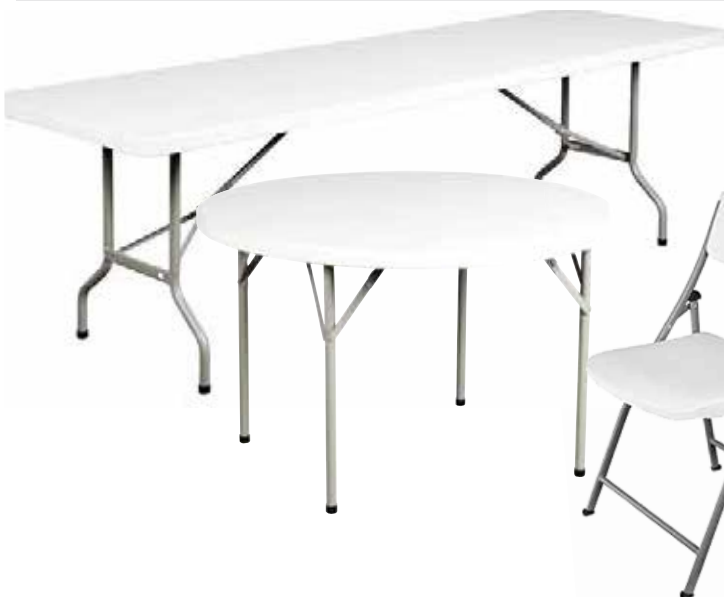

B HDL TOUGHLITE FOLDING TABLES AND CHAIRS

Durable polyethylene resin table top with sturdy powder coated metal base that supports up to 300 lbs. The chairs have a maximum weight capacity of 240 lbs. Granite. Tables are 29" H.

ORDER NUMBER	DESCRIPTION	UNIT
1 TLT-2448-GN	48"W×24"D	EA
2 TLT-3060-GN	60"W×30"D	EA
3 TLT-3072-GN	72"W×30"D	EA
4 TLT-3096-GN	96"W×30"D	EA
5 TLT-R45-GN	45" Round	EA
6 TLT-R60-GN	60" Round	EA
7 TLT-FCB6-GN	Folding chairs	EA

C HDL® TOUGHLITE FOLDING CHAIR STORAGE CART

Convenient storage and transport of Toughlite folding chairs. Features drop in sides for easy stacking and loading, heavy duty locking casters and a sturdy handle. Granite.



ORDER NUMBER	DESCRIPTION	UNIT
TLT-CCART-GN	58"W×21 1/2"D×75"H	EA



D HDL® TOUGHLITE FOLDING TABLE STORAGE CART

Convenient storage and transport of Toughlite folding tables. Vertical storage allows various tables sizes to be stored together. Features an open ended design for easy loading, heavy duty locking castors and sturdy handle. Granite.

ORDER NUMBER	DESCRIPTION	UNIT
TLT-TCART-GN	68 1/4"W×34 3/4"D×40"H	EA

Tables

HDL® INNOVATIONS TABLES: Commercial grade, 1" thick table top with durable 2mm PVC edging. Sturdy metal counter-weighted base with adjustable levellers.

LAMINATE FINISH COLOURS



BASE COLOURS



Shown in *laminated finish*
EZ Evening Zen

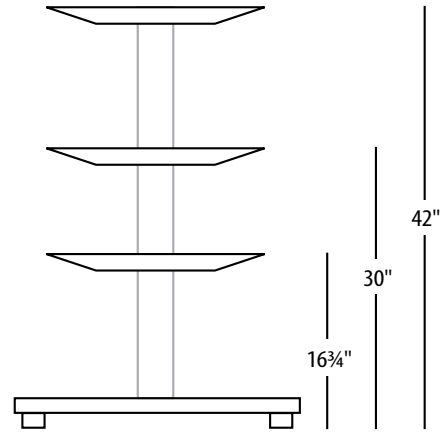

A HDL® INNOVATIONS CAFETERIA TABLES

ORDER NUMBER	DESCRIPTION	UNIT
1 INVSQ36TBL SQB20	36"×36"×30"H	EA
2 INVR36TBL SQB20	36" Round, 30"H	EA



Shown in *laminated finish*
GD Grey Dusk



Shown in *laminated finish*
EZ Evening Zen

B HDL® INNOVATIONS BAR HEIGHT TABLES

ORDER NUMBER	DESCRIPTION	UNIT
1 INVSQ36TBL SQB20BAR	36"×36"×42"H	EA
2 INVR36TBL SQB20BAR	36" Round, 42"H	EA

C HDL® INNOVATIONS COFFEE TABLES

ORDER NUMBER	DESCRIPTION	UNIT
1 INVSQ36TBL SQB20CFT	36"×36"×16 3/4"H	EA
2 INVR36TBL SQB20CFT	36" Round, 16 3/4"H	EA

604 Call for more model & laminate selections. Freight charges may apply. Check online for the most current price.

OFFICES TO GO™ IONIC TABLES: General purpose tables. Features a metal base with 2 1/2" square column and adjustable leveling glides. Metal legs with Sandtex finish for durability.

LAMINATE FINISH COLOURS



BASE COLOURS



A OFFICES TO GO™ IONIC TABLES

ORDER NUMBER	DESCRIPTION	UNIT
1 ML36RX	36" Round, 29"H	EA
2 ML30SX	30"×30"×29"H	EA
3 ML36SX	36"×36"×29"H	EA

B OFFICES TO GO™ IONIC BAR HEIGHT TABLES

ORDER NUMBER	DESCRIPTION	UNIT
1 ML36RX42	36" Round, 42"H	EA
2 ML36SX42	36"×36"×42"H	EA



C OFFICES TO GO® IONIC COFFEE TABLES

ORDER NUMBER	DESCRIPTION	UNIT
1 ML30RX22	30" Round, 22"H	EA
2 ML30SX22	30"×30"×22"H	EA

D OFFICES TO GO® IONIC H-LEG COFFEE TABLES

ORDER NUMBER	DESCRIPTION	UNIT
1 ML3620CH	36"W×20"D×16"H	EA
2 ML4220CH	42"W×20"D×16"H	EA

Call for more model & laminate selections. Freight charges may apply. Check online for the most current price. **605**

Laminate finishes

GLOBAL® AND OFFICES TO GO™ FURNITURE

ACJ <i>Absolute Acajou</i>	ASN <i>Asian Night</i>	AWC <i>Avant Cherry</i>	AWH <i>Avant Honey</i>	CMB <i>Clear Maple</i>	DES <i>Dark Espresso</i>
DWT <i>Designer White</i>	HGT <i>Hayden Gray</i>	NBL <i>Noce Blondo</i>	NEL <i>Noce Leggero</i>	NGL <i>Noce Grigio</i>	NML <i>Noce Medio</i>
SKM <i>Shaker Cherry</i>	TWL <i>Tiger Walnut</i>	WCR <i>Winter Cherry</i>	WHC <i>White Chocolate</i>	WHT <i>White</i>	

HDL®/STAR FURNITURE

AM <i>Autumn Maple</i>	EO <i>Espresso</i>	EZ <i>Evening Zen</i>	FM <i>Figured Mahogany</i>	GD <i>Grey Dusk</i>	GR <i>Grey</i>
HC <i>Henna Cherry</i>	HM <i>Hardrock Maple</i>	RM <i>Royal Mahogany</i>	SM <i>Sugar Maple</i>	WW <i>Winter Wood</i>	

LINKS® FURNITURE

CH <i>Cherry Henna</i>	CM <i>Classic Mahogany</i>	CO <i>Cognac</i>	CP <i>Cappuccino</i>	CW <i>Chocolate Walnut</i>	LB <i>Lime Burst</i>
LN <i>London Fog</i>	MW <i>Milky Way</i>	NM <i>Nutmeg</i>	RM <i>Riviera Maple</i>	SA <i>Sahara</i>	TW <i>True White</i>
WC <i>Windy City</i>	WG <i>Willow Grey</i>				

606 Call for more model & laminate selections. Freight charges may apply. Check online for the most current price.

Globalcare - Quality of Life Products

Globalcare produces products specifically designed to promote correct body positioning and alignment for an enhanced level of wellness, while meeting the quality standards and demands of healthcare settings. Whether your needs are for hospital or long term care facilities, Globalcare products provide quality furniture solutions that are compliant to the demands of the healthcare industry.



Filing Cabinets – vertical



FILE/STORAGE COLOURS

BLK Black	DWT White	GRY Grey



Locks included

A GLOBAL™ 2600 VERTICAL FILE CABINETS – HANDLE PULL FRONT

Full height side walls eliminate the need for hanging file frames. With locks. Two-drawer 29" H, three-drawer 40" H, four-drawer 52" H; 26⁵/₁₆" D. Colours: **BLK** Black, **DWT** Designer White, **GRY** Grey. Specify colour.

ORDER NUMBER	DESCRIPTION	UNIT
LETTER SIZE, 15" W x 26⁵/₁₆" D		
1 26-201-	Two-drawer	EA
2 26-301-	Three-drawer	EA
3 26-401-	Four-drawer	EA

ORDER NUMBER	DESCRIPTION	UNIT
LEGAL SIZE 18" W x 26⁵/₁₆" D		
4 26-251-	Two-drawer	EA
5 26-351-	Three-drawer	EA
6 26-451-	Four-drawer	EA



FILE/STORAGE COLOURS

BLK Black	DWT White	GRY Grey



Removable cam lock



High side walls



Locks included

B GLOBAL™ 2600 PLUS VERTICAL FILES – FLUSH FRONT

High end styling, economy price. Sturdy construction includes double wall fronts and full cradle suspension. High side walls support hanging files eliminating the need for separate file frames. Flush front with recessed full pull matches Global 9100 series lateral file cabinet style. Two-drawer 29" H, three-drawer 40" H, four-drawer 52" H. Colours: **BLK** Black, **DWT** Designer White, **GRY** Grey. Specify colour.

ORDER NUMBER	DESCRIPTION	UNIT
LETTER SIZE, 15" W x 26⁵/₁₆" D		
1 26-202-	Two-drawer	EA
2 26-302-	Three-drawer	EA
3 26-402-	Four-drawer	EA

ORDER NUMBER	DESCRIPTION	UNIT
LEGAL SIZE 18" W x 26⁵/₁₆" D		
4 26-252-	Two-drawer	EA
5 26-352-	Three-drawer	EA
6 26-452-	Four-drawer	EA

608 Call for more model & laminate selections. Freight charges may apply. Check online for the most current price.

Filing Cabinets – vertical and end tab



FILE/STORAGE COLOURS



A OFFICES TO GO™ MVL25 SERIES VERTICAL FILING CABINETS

Full pull drawer fronts; central core removable cam lock. Optional follower blocks. All models are 25" D. Two-drawer 29" H, four-drawer 52" H. Colours: **BLK** Black, **DWT** Designer White, **GRY** Grey. Specify colour.

ORDER NUMBER	DESCRIPTION	UNIT
1 MVL25201-	Letter size, two-drawer, 15"W	EA
2 MVL25401-	Letter size, four-drawer, 15"W	EA
3 MVL25251-	Legal size, two-drawer, 18"W	EA
4 MVL25451-	Legal size, four-drawer, 18"W	EA
5 MVLFB	Follower block	EA



B OFFICES TO GO™ MVLW23 SERIES PEDESTALS

May be used to support standard work surface. Standard with removable core cam lock and levelling glides. Mobile pedestals include recessed casters and counter weights. BBF model includes a pencil tray; file drawers include conversion bars for side-to-side filing. Greenguard certified. 15"W×23"D×27⁵/₈"H. Colours: **BLK** Black, **DWT** Designer White, **GRY** Grey. Specify colour.

ORDER NUMBER	DESCRIPTION	UNIT
1 MVLW23BBF-	Box/box/file pedestal	EA
2 MVLM23BBF-	Box/box/file mobile pedestal	EA
3 MVLW23FF-	File/file pedestal	EA
4 MVLM23FF-	File/file mobile pedestal	EA



FILE/STORAGE COLOURS



C GLOBAL™ END TAB FILING CABINETS

Feature receding doors and fixed shelves. Accommodates end tab folders and accordion style tab folders. Colours: **BLK** Black, **DWT** Designer White, **GRY** Grey. Specify colour.

ORDER NUMBER	DESCRIPTION	UNIT
1 ET-1236P2	2-drawer, 29"H×18"D×36"W	EA
2 ET-1236P3	3-drawer, 42"H×18"D×36"W	EA
3 ET-1236P4	4-drawer, 56 ¹ / ₄ "H×18"D×36"W	EA
4 ET-1236P5	5-drawer, 69 ¹ / ₄ "H×18"D×36"W	EA
5 ET-1236P6	6-drawer, 82 ³ / ₈ "H×18"D×36"W	EA
6 ETFB36	Conversion bar – legal to letter, 36"W	EA

Call for more model & laminate selections. Freight charges may apply. Check online for the most current price. **609**

Filing Cabinets – lateral



FILE/STORAGE COLOURS

BLK Black	DWT White	GRY Grey
------------------	------------------	-----------------

A GLOBAL™ 9300 LATERAL FILES

Hold letter, legal and A4 metric size files on the hanging file bars included in each drawer. Drawers operate smoothly on slides and full suspension systems. Levelling glides allow adjustment on carpets and uneven floors. All bottom drawers have fixed fronts. Available in fixed front or receding front door styles. Dimensions: 36" W×18" D. Colours: **BLK** Black, **DWT** Designer White, **GRY** Grey. Specify colour.

ORDER NUMBER	DESCRIPTION	UNIT	ORDER NUMBER	DESCRIPTION	UNIT		
1	9336-2F1H-__	2 Drawer, 27½"H, Fixed front	EA	LATERAL FILE ACCESSORIES			
2	9336-2R1H-__	2 Drawer, 27½"H, Receding front	EA	9	PD	Plate dividers	3/PK
3	9336-3F1H-__	3 Drawer, 40½"H, Fixed front	EA	10	FBB	Front to back bars	PR
4	9336-3R1H-__	3 Drawer, 40½"H, Receding front	EA	11	HFB36	Side to side bars	PR
5	9336-4F1H-__	4 Drawer, 54"H, Fixed front	EA	12	EDPS	EDP side adapters	PR
6	9336-4R1H-__	4 Drawer, 54"H, Receding front	EA				
7	9336-5F1H-__	5 Drawer, 65¼"H, Fixed front	EA				
8	9336-5R1H-__	5 Drawer, 65¼"H, Receding front	EA				



FILE/STORAGE COLOURS

BLK Black	DWT White	GRY Grey
------------------	------------------	-----------------

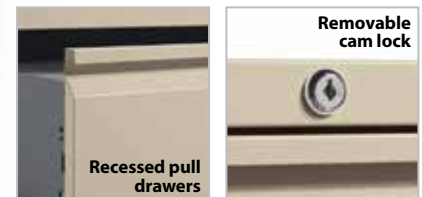

B OFFICES TO GO™ 1900 SERIES LATERAL FILES

All units feature full extension 3-stage ball bearing drawer suspension and fixed drawer fronts with angled looped full pull. Welded seamless corners add strength and give a clean appearance; levelling glides ensure easy opening drawers. Interlock system allows only one drawer open at a time, which prevents tipping. Side-to-side hanging file bars (for letter, legal or A4 folders), counterweight and central core removable cam lock included; optional front-to-back file bars available. Dimensions: 36" W×19.25" D. Colours: **BLK** Black, **DWT** Designer White, **GRY** Grey. Specify colour.

ORDER NUMBER	DESCRIPTION	UNIT	ORDER NUMBER	DESCRIPTION	UNIT		
1	MVL1936P2-__	Two-drawer, 27.14" H	EA	ACCESSORIES			
2	MVL1936P3-__	Three-drawer, 39.52" H	EA	5	MVLPD	Plate dividers	3/PK
3	MVL1936P4-__	Four-drawer, 51.89" H	EA	6	MVLFBB	Front to back bars	PR
4	MVL1936P5-__	Five-drawer, 66.39" H	EA	7	MVLHFB36	Side to side bars	PR

610 Call for more model & laminate selections. Freight charges may apply. Check online for the most current price.

Filing Cabinets – insulated



A GARDEX® GRAND PRIX FIRE-RESISTANT STORAGE SAFES

UL® Class 350 Certified 1-hour fire and impact ratings ensure that paper records vital to your business will be protected in a fire disaster. The mechanical combination lock standard on all models provides additional peace of mind. Integral caster base and adjustable shelf / shelves also included on all models. Durable textured paint in beige colour. Five year parts warranty covers manufacturers defects in materials and workmanship and Lifetime Fire Replacement Warranty.

ORDER NUMBER	FIRE PROTECTION	CAPACITY	TYPE	EXTERIOR DIMENSIONS WxDxH (IN.)	WEIGHT (LBS.)
1 GX1-21	1 hour	2.2 cu.ft.	1 shelf	18½"×18½"×24"	168
2 GX2-21	1 hour	3.92 cu.ft.	1 shelf	21½"×21½"×29"	252
3 GX3-21	1 hour	9.36 cu.ft.	3 shelves	26½"×26½"×39"	480
4 GX4-21	1 hour	12.29 cu.ft.	4 shelves	26½"×26½"×50½"	560

Extra delivery charges may apply due to excessive weight.



B GARDEX® CLASSIC SERIES FIRE RESISTANT VERTICAL FILES

UL® Class 350 Certified 1-hour rating ensures critical documents are protected in a fire. Each drawer compartment has a welded steel inner jacket that ensures structural integrity and keeps insulation locked in. Legal widths detailed below; call if letter required. Full-extension ball-bearing carriage suspensions roll smoothly and minimize sway of loaded drawers. Textured, scratch-resistant paint finish in beige.

ORDER NUMBER	FIRE PROTECTION	TYPE	EXTERIOR DIMENSIONS WxDxH (IN.)	WEIGHT (LBS.)
1 GF25-2-21	1 hour	2 drawer 25"	19¾"×25"×28"	320
2 GF200-21	1 hour	2 Drawer 31"	19¾"×31"×28"	386
3 GF300-21	1 hour	3 Drawer 31"	19¾"×31"×41"	520
4 GF25-4-21	1 hour	4 Drawer 25"	19¾"×25"×54"	556
5 GF400-21	1 hour	4 Drawer 31"	19¾"×31"×54"	670

Extra delivery charges may apply due to excessive weight.



C GARDEX® CLASSIC SERIES FIRE RESISTANT LATERAL FILES

UL® Class 350 Certified 1-hour rating ensures your vital files are protected in a devastating fire. Each drawer compartment has a welded steel inner jacket that keeps insulation locked in and provides enhanced structural integrity. Full height drawer bodies and included hanging rails permit filing of documents that are letter, legal or both. Sway-Gard three arm system of full extension ball-bearing drawer slides. Textured, scratch-resistant paint finish in beige.

ORDER NUMBER	FIRE PROTECTION	TYPE	EXTERIOR DIMENSIONS WxDxH (IN.)	WEIGHT (LBS.)
1 GL402-21	1 hour	2 drawer	38¾"×23½"×29"	538
2 GL403-21	1 hour	3 Drawer	38¾"×23½"×42"	740
3 GL404-21	1 hour	4 Drawer	38¾"×23½"×55"	960

Extra delivery charges may apply due to excessive weight.

Storage cabinets



FILE/STORAGE COLOURS

BLK Black	DWT White	GRY Grey

URBAN FABRIC COLOURS

UR21 Gravel Road	UR22 Black Coal

A OFFICES TO GO™ MOBILE PEDESTALS

24 $\frac{3}{8}$ " high allows for underdesk work surface placement 1 Box and 1 File Drawer. Assembly not included. Colours: **BLK** Black, **DWT** Designer White, **GRY** Grey. Specify colour.



ORDER NUMBER	DESCRIPTION	UNIT
1 MVL19BF	15"W×19"D×24 $\frac{3}{8}$ "H	EA
2 MVL23BF	15"W×23"D×24 $\frac{3}{8}$ "H	EA
3 MVL19C	19" Cushion	EA
4 MVL23C	23" Cushion	EA



FILE/STORAGE COLOURS

BLK Black	DWT White	GRY Grey



B OFFICES TO GO™ STORAGE CABINET

With one fixed and three adjustable shelves; bottom pan can also be used as a shelf. Door fronts feature a recessed angled full pull. Removable core cam lock included; levelling glides are standard. Durable environmentally friendly paint coating (electrostatically applied); Greenguard certified. 36" W×18" D×72" H. Colours: **BLK** Black, **DWT** Designer White, **GRY** Grey. Specify colour.

ORDER NUMBER	UNIT
MVLS72L-	EA



FILE/STORAGE COLOURS

BLK Black	DWT White	GRY Grey



C GLOBAL™ STORAGE WARDROBE

Lockable storage wardrobe with two compartments. The first compartment has 3 adjustable shelves, 1 fixed shelf and 1 file drawer. The second compartment has a 67" storage section for extra long coats. Fully assembled. Dimensions: 36"W×20"D×72"H. Colours: **BLK** Black, **DWT** Designer White, **GRY** Grey. Specify colour.

ORDER NUMBER	UNIT
93SW2072-	EA

612 Call for more model & laminate selections. Freight charges may apply. Check online for the most current price.

Storage cabinets



FILE/STORAGE COLOURS

BLK Black	DWT White	GRY Grey
------------------	------------------	-----------------

A GLOBAL™ MULTI-STOR

Handles storage and filing needs in one unit. The storage cabinet has 2 fixed shelves and 1 adjustable shelf. The 2 lateral file drawers have hanging file bars installed ready-to-use. The storage cabinet and file cabinet have separate locks. Levelling glides allow adjustments for uneven floors. 36" W×18" D×65¼" H. Colours: **BLK** Black, **DWT** Designer White, **GRY** Grey. Specify colour.

ORDER NUMBER	UNIT
9336-5MSL-__	EA



FILE/STORAGE COLOURS

BLK Black	DWT White	GRY Grey
------------------	------------------	-----------------

B GLOBAL™ STORAGE CABINETS

With lock and one fixed centre shelf. Dimensions: 36" W×18" D. Colours: **BLK** Black, **DWT** Designer White, **GRY** Grey. Specify colour.

ORDER NUMBER	DESCRIPTION	UNIT
1 9336-S42L-__	42" H, 1 fixed centre shelf, 1 adjustable shelf	EA
2 9336-S72L-__	72" H, 1 fixed centre shelf, 3 adjustable shelves	EA



FILE/STORAGE COLOURS

BLK Black	DWT White	GRY Grey
------------------	------------------	-----------------

C GLOBAL™ EXHIBIT FILE CABINET

Three open slotted shelves plus storage compartment. Three plate dividers per shelf. Two high lateral file with one 'B' opening and one 'L' opening. 'B' denotes big or binder size (12⅞"). 'L' denotes little or letter/legal size (11⅞"). Dimensions: 36" W×18" D×65¼" H. Colours: **BLK** Black, **DWT** Designer White, **GRY** Grey. Specify colour.

ORDER NUMBER	UNIT
9336P-5FX-__	EA



A SENTRY®SAFE SECURITY SAFES

All Sentry®Safe security safe products have a one-year manufacturer's warranty.

ORDER NUMBER	LOCK TYPE	LIVE LOCKING BOLTS	ANCHOR FEATURE	EXTERIOR DIMENSIONS H×W×D (IN.)	FEATURES	WEIGHT (LBS.)	CAPACITY (CU. FT.)
SECURITY SAFES							
1 X055	Electronic with override key	2	Bolt-down hardware	8.7×13.8×10.6	Pry resistant door and body; carpeted floor	14.2	0.58
2 X075	Electronic with override key	2	Bolt-down hardware	7.1×16.9×14.6	Fits most laptops; power cord access; carpeted floor	17.15	0.78
3 X125	Electronic with override key	2	Bolt-down hardware	10.6×16.9×14.6	Fits most laptops; removable shelf; power cord access	26.84	1.18
4 T0331	Electronic with override key	3	Bolt-down hardware	37.7×21.7×19.8	Three adjustable shelves; carpeted interior; anti-drill door	220	6.01
DEPOSITORY SECURITY SAFES							
5 UC-025K	Key lock	N/A	Bolt-down hardware	8.5×6×12.3	Anti-drill door; anti-fish hopper	20	0.23
6 DH-074E	Electronic lock with time delay	3	Bolt-down, pre-drilled holes	20×14×15.6	Anti-drill door; anti-fish hopper; anti-drill relock plate; relocking device	95	0.94
7 DH-109E	Electronic lock with time delay	3	Bolt-down, pre-drilled holes	24×14×15.6	Anti-drill door; anti-fish hopper; anti-drill relock plate; relocking device	108	1.3

614 Call for more model & laminate selections. Freight charges may apply. Check online for the most current price.



A SENTRY®SAFE FIRE-SAFE® CHESTS, FILES AND SAFES

Portable security chests, files and safes designed to protect valuable documents, including computer media (CDs, DVDs, memory cards, USB drives). Insulated and tested to provide protection in case of fire or explosion. All Sentry®Safe Fire-Safe® products have a one year manufacturer's warranty and a lifetime after-fire replacement guarantee. See below for specific model information.

ORDER NUMBER	UL CLASS 350 & EXPLOSION	MEDIA FIRE PROTECTION	WATER ETL VERIFIED	LOCK TYPE	EXTERIOR DIMENSIONS H×W×D (IN.)	FEATURES	WEIGHT (LBS.)	CAPACITY (CU. FT.)
1 CHW30300	½ hour	Yes	72 hours	Digital lock	7.6×16.5×14.8	Holds letter size paper	24	0.36
2 CHW20201	½ hour	Yes	72 hours	Tubular key	6.6×15.4×14.3	Holds letter size documents laid flat, digital media	20.4	0.28
3 FHW40200NAFHRO	½ hour	Yes	72 hours	Tubular key	14.1×16.6×13.8	Larger capacity – holds letter size hanging files, digital media	41	0.66
4 SFW082GTC	1 hour	Yes	5" for 24 hours	Dual digital lock with backlit keypad and key	13.7×16.3×19.3	Programmable lock, three 1" locking bolts, multi-position shelf	78.64	0.81
5 SFW082DTB	1 hour	Yes	5" for 24 hours	3-number combo lock with key	13.7×16.3×19.3	Three 1" locking bolts, multi-position shelf	78.64	0.81
6 SFW123GDC	1 hour	Yes	8" for 24 hours	Dual electronic lock with key	17.8×16.3×19.3	Interior light, larger bolts, pry resistant hinge bar, locking drawer	86.69	1.23
7 SFW123DSBSSC	1 hour	Yes	8" for 24 hours	Dual mechanical combo with key	17.8×16.3×19.3	Larger bolts, pry resistant hinge bar, and multi-position shelf	87.34	1.23
8 SFW205GQCSSC	1 hour	Yes	8" for 24 hours	Digital with backlit keypad and dual key	23.8×18.6×19.3	Six large live-locking bolts, file organizer and 5" deep organizer	124.8	2
9 EF3428E	½ hour	No	12" for 72 hours	Programmable electronic lock with override key	27.8×21.7×19	Seven oversized bolts, two multi-position shelves	163	3.39

Call for more model & laminate selections. Freight charges may apply. Check online for the most current price. **615**

A

11x17 Binders179

Academic Planners & Pads . 142, 148, 152

Accounting

- Account Books.....163, 164
- Analysis Pads..... 165
- Columnar Books 163
- Columnar Pads 165
- Ledger Outfits 164
- Ledger Sheets 164

Acrylic Paint.....383

Adapter Cables77, 78

Adapters

- Label Printer110, 112
- Network..... 82
- Travel 40
- Wireless 82

Add Rolls.....328

Adding Machines 102, 103

Address Books253

Adhesive Putty241

Adhesive Vinyl.....120

Adhesives & Glues

- Fun Tak..... 241
- Glue Guns242, 496
- Glue Sticks 241, 243, 368
- Crazy® Glue 243
- No More Nails® 496
- Roller 242
- Rubber Cement..... 242
- School Glue242, 368
- Spray 241
- Tac N Stik® 241
- Multi-Purpose ... 242, 243, 368, 496
- Wood 496

Admission Tickets326

Advil®464

Air Conditioners477

Air Duster69

Air Freshener 451, 452

Air Horn488

Air Pillows511

Air Purifiers 448, 450

Alcohol Swabs463

Alkaline Batteries.....74, 75

All Purpose Cleaner428-430

Aluminum Foil.....415

Analysis Pads165

Antacid417

Anti-Fatigue Mats..... 478, 479, 556

Antiseptic Swabs.....463

Appliances 403, 408, 418, 419

Appointment Books & Refill

- Academic..... 152
- Daily143, 144
- Monthly147, 148
- Perpetual 142
- Weekly..... 145-147

Apron468

Archboard Files199

Arms - Monitor......62, 63

Art & Craft Supplies

- Acrylic Paint..... 383
- Art Kits..... 378
- Art Pens 386
- Artboard 357
- Artist Portfolios..... 355
- Beads 366
- Border 398
- Bristol Board 355
- Burnisher & Blender..... 377
- Calligraphy Ink 386
- Calligraphy Kits.....386, 387
- Calligraphy Markers. 300, 375, 386, 387
- Calligraphy Paper387
- Canvas 356
- Canvas Paper..... 356
- Cellophane..... 363
- Charcoal Pencils 377
- Chenille Stems 366
- Coloured Pencils . 370, 371, 378, 379
- Colouring Book 372
- Colouring Markers 373
- Colouring Mats 367
- Construction Paper..... 362
- Conte Crayons 377
- Corrugated Paper Roll 363
- Craft Sticks..... 365
- Crayons..... 308, 372, 379
- Crepe Paper 363
- Doilies 367
- Door Hangers 367
- Drawing Ink..... 387
- Drawing Paper 359, 360
- Drawing Pencils 378
- Easels 356
- Eyes..... 365
- Face Paint..... 367
- Feathers 366
- Felt 364, 366

- Finger Paint Paper357
- Finger Paint Tray381
- Fixative..... 377
- Foam Sheets 364
- Foamboard 355
- Gesso 356
- Glitter..... 367
- Graphic Art Tape 341
- Knives..... 354
- Kraft Paper Roll..... 363
- Lap Desk 389
- Lettering 354
- Marker Paper.....357, 360
- Markers 374
- Mixed Media Paper..... 359
- Modelling Clay 369
- Mural Roll 363
- Oil & Acrylic Paper 357
- Oil Paint 382
- Organizers 388
- Paint Brushes 381, 385, 492
- Paint Cups 380
- Paint Knives..... 384
- Paint Markers 297
- Paint Palette380, 384
- Paper Bags..... 364
- Paper Chalk 376
- Paper Plates..... 364
- Paper Stumps 377
- Pastel Paper..... 359, 360
- Pastels 376
- Pen & Ink Paper 360
- Pencil Sets 370, 378, 379
- Pencil Sharpeners..... 311, 312, 371
- Pom Poms 365
- Project Display Board..... 355
- Scissors..... 314, 315, 395
- Scrapbooks 361
- Sketch Books..... 358, 359
- Slime 368
- Smock..... 381
- Stencils..... 354
- Stickers..... 399, 400
- Storage Boxes 389
- Styrofoam 367
- Supplies Caddy 372, 390
- Tempera Paint..... 380
- Thread 366
- Tissue Paper 363
- Tracing Paper..... 361
- Varnish..... 384
- Washable Paint..... 380, 381
- Watercolour Paint..... 382
- Watercolour Paper 357, 360
- Window Markers..... 374

Art & Drawing File Storage	355	Battery Backup	71	Body Lotion	455
Art Markers	373	Beads	366	Book Cover	120
Art Pencils	370, 377-379	Beam Seating	539	Book Stand	68
Art Supplies Caddy	372, 390	Bell, Call	253	Book Tape	238
Artificial Sweetener	410	Bench	505	Bookcases	568, 596, 597
Artist Portfolios	355	Bill Counter	325	Bookends	223
Attache Cases	38	Binder Paper	181	Books	
Audio Visual		Binder Pockets	182	- Accounting	163, 164
- Carts	599	Binder Pouch	182	- Address	253
- Multimedia Projectors	92	Binders		- Appointment.....	142-148, 152
- Pointers	93	- 11x17	179	- Columnar.....	163
- Projection Screens	93	- Cheque.....	165	- Document Saver	195
Auto Record Book	168	- Clamp.....	191	- Expense	168
Avmor® Urinal Cleaner	432	- Data	178	- Guest	253
Awards - Student	399	- D-Ring	41, 177, 178	- Inspection Log.....	168
B					
Backpack Pouch	371	- Legal.....	179	- Memo.....	155, 157, 160
Backpacks	37	- Overlay.....	175, 176, 178, 179	- Notebooks	154-160, 391
Backrests	66	- Presentation	178	- Password	252
Badge Accessories	140	- Round Ring	175, 177-179	- Payroll	165
Badge Holder Reel Clips	139	- Small Page.....	179	- Presentation	355
Badge Holders & Inserts	139	- Zippered.....	41, 180	- Receipt.....	166
Badges - Name	139, 140	Binding Cases	222	- Record	168
Bags - Bank Deposit Bags	326	Binding Machines & Supplies . 114, 115		- Sketch.....	358, 359
Bags		Bingo Daubers	375	- Steno	160
- Craft	364	Bins, Parts	502	- Telephone Address.....	253
- Garbage.....	484, 485	Blades, Knife	354, 493, 494	- Telephone Message	252
- Pound.....	507	Blanket	465	Boot Tray	486
- Shopping	327	Bleach	429, 438	Border	398
- Shredder	100	Bleach Germicidal	466	Bottle Scrubber	422
- Zipper.....	322	Blood Pressure Monitor	466	Bouffant Caps	468
Ballot Boxes	333	Blood Pressure Monitor	466	Bounce®	438
Ballpoint Pens	273-275, 282	Blueprint Hanging Files	222	Bowls	412
Bandage Scissors	462	Boards & Accessories		Box Sealing Tape & Dispensers 513, 514	
Bandages	460-462	- Chalk/Chalk Holders.....	396	Boxes	
Bank Deposit Bags	326	- Chalkboard Brush.....	396	- Ballot Boxes.....	333
Bankers Box®	219, 220	- Chalkboards.....	346	- Card File	257
Bankers Box® at Play	395	- Cleaner.....	344	- Cardboard	510
Barriers	504, 593	- Combo Boards.....	338, 339	- Cash	324
Bathroom Cleaner	431	- Cork Boards	345, 346	- File	215-217, 219-221
Bathroom Tissue	434, 435	- Fabric Boards.....	346	Brass Fasteners	236
Batteries		- Glass Boards	334-337	Breakroom Appliances	
- Alkaline	74, 75	- In/Out.....	252	- Coffee Maker.....	403, 408
- Battery Charger.....	74	- Magnetic Marker Holder	340, 341	- Kettle	408
- Lithium	74	- Magnets.....	341	- Microwave	419
- Rechargeable	74	- Map Flags	345	- Refrigerator	418
- Silver Oxide	74	- Map Pins	345	- Toaster	418
		- Marker Board Markers	342-344	- Toaster Oven	418
		- Marker Boards.....	334-338	- Water Dispenser	419
		- Project	355		
		- Push Pins	345		
		- Whiteboard Eraser	340, 341		

Breakroom Supplies

- Aluminum Foil 415
- Bottle Scrubber 422
- Bowls 412
- Coffee & Tea 404-407, 409, 410
- Coffee Filters 408
- Cups 411
- Cutlery 413
- Dish Brush 422
- Dish Soap 420, 421
- Dishwand 422
- Food Containers 412, 414
- Food Film 415
- Glad® Bags 415
- Hot Chocolate 406
- K Cup Storage 403
- Milk 410
- Napkins 414
- Paper Cup Dispenser 411
- Paper Towels 436, 437
- Pitcher 412
- Plastic Wrap 415
- Plates 412
- Rinse Aid 420
- Salt & Pepper 412
- Scouring Pads 422
- Snacks 416, 417
- Soup 416
- Stir Sticks 411
- Straws 413
- Sugar 410
- Sweetener 410
- Water Bottles 412
- Ziploc® Bags 414, 415
- Bristol Board 355**
- Brooms 440, 441**
- Brother Labels 111**
- Brother® Drums 6, 7, 23**
- Brother® Inkjet Cartridges 7-10, 24**
- Brother® Toner 6, 7**
- Brush Markers 373-375**
- Brushes - Chalkboard 396**
- Brushes - Paint 381, 385, 492**
- Bubble Envelopes 320**
- Bubble Wrap 511**
- Buckets 424, 443**
- Buffet Carts 600**
- Bug Killer 485**

- Building Blocks 395**
- Bulldog Clips 235**
- Bulletin Board Borders 398**
- Bulletin Boards 338, 339, 345, 346**
- Bundling Straps 76**
- Bunn® Coffee Systems 408**
- Burn Gel Pack 459, 463**
- Burnisher & Blender 377**
- Business Card Files 254-256**
- Business Card Holders 224, 254, 255**
- Business Card Pockets 255**
- Business Cards 256**
- Business Cases**
 - Backpacks 37
 - Laptop Case 34-38
 - Portfolios 34, 41
 - Salesman Case 39
 - Wheeled 38
- Business Forms**
 - Delivery Receipt 167
 - Garage Repair 168
 - Interoffice Memo 167
 - Invoice 167
 - Purchase Order 167
 - Requisitions 167
 - Restaurant Check 166
 - Sales Order 166, 167
 - Security Receipt 166
 - Statements 167
 - Time Sheet 167
- Business Machines & Supplies**
 - Calculators, Desktop 102-105
 - Calculators, Handheld 104, 106
 - Calculators, Metric Conversion ... 106
 - Calculators, Scientific 107
 - Label Printer Tape 110, 113
 - Label Printers 109-112
 - Laminators & Supplies 117-120, 140, 331
 - Shredders 95-100
 - Telephone Accessories 89
 - Telephone Address Books 253
 - Telephone Message Books & Pads 252
 - Telephones 90
 - Voice Mail Log Book 252
- Business Pads 161, 162**
- Button Batteries 74**

C

- Cabinets, Storage 613**
- Cable Ties/Wrappers 76**
- Cables**
 - Adapters 77, 78
 - Charging 76
 - Displayport 77
 - Ethernet 76
 - HDMI 77, 78
 - Lightning 76
 - Monitor 78
 - USB 77, 78
- Caddy**
 - Art Supplies 372, 390
 - Janitorial Supply 424
- Cafeteria Tables 604**
- Calculators**
 - Desktop 102-105
 - Handheld 104, 106
 - Metric Conversion 106
 - Scientific 107
- Calendar Pads & Refills .. 141, 150, 152**
- Calendars 149**
- Call Bell 253**
- Calligraphy Ink 386**
- Calligraphy Kits 386, 387**
- Calligraphy Markers 300, 375, 386**
- Calligraphy Paper 387**
- Canada Flag 393, 486**
- Candy 417**
- Canon® Inkjet Cartridges 11, 12**
- Canon® Toner 10**
- Canvas 356**
- Carbon Monoxide Detector 475**
- Carbon Paper 168**
- Card & Cover Stock 126**
- Card Collector Sheets 181**
- Card File Boxes 257**
- Card File Pockets 257**
- Card Files 254-256**
- Card Guides 257**
- Card Holders, Business ... 224, 254, 255**
- Cardboard Boxes 510**

- Cards**
- File 256
 - Greeting 132
 - Index 257
 - Note 129, 132
- Carpet Cleaner** 446
- Carpet Deodorizer** 446
- Carpet Tape** 238, 496
- Carts**
- Audio Visual 599
 - File 218
 - Janitorial 218, 444
 - Luggage 39
 - Mail 506
 - Utility 501
- Cases**
- Binding Cases 222
 - Business 34, 36
 - Laptop 34-36
 - Salesman 39
- Cash Boxes, Trays, & Drawers** 324
- Cash Counter** 325
- Cash Trays** 324
- Casters** 538
- Catalogue Case** 39
- Catalogue Envelopes** 319, 321
- Category 5 Cables** 76
- Category 6 Cables** 76
- Caution Tape** 496
- CD Labels** 45
- CD Pockets** 45
- CD/DVD Page Holders** 45
- CD/DVD Storage** 45
- CDs** 45
- Cellophane** 363
- Cement, Rubber** 242
- Certificate Frames** 131
- Certificates - Recognition** ... 130, 399
- Certificates - Gift** 131
- Chair Casters** 538
- Chair Slippers** 396
- Chairmats** 548, 549
- Chairs**
- Drafting 537, 538
 - Folding 535, 603
 - Gaming 544
 - Guest 534-538
 - Multi Tilter 518-525
 - Operator 530, 537
 - Stacking 535, 536
 - Synchro Tilter 526, 527
 - Task 533
 - Tilter 528-532
- Chalk Markers** 302, 342, 396
- Chalk/Chalk Holders** 396
- Chalkboard Brush** 396
- Chalkboards** 346
- Charcoal Pencils** 377
- Chargers, USB** 40
- Charging Cables** 76
- Charging Pad** 79
- Checking Pencil** 392
- Chenille Stems** 366
- Cheque Binder** 165
- China Markers** 302
- Chips** 416
- Clamp Binders** 191
- Classification Folders** 207
- Classroom Furniture** 543
- Classroom Storage** 389, 390
- Classroom Supplies** 389-400
- Clay - Modelling** 369
- Cleaner**
- Air Duster 69
 - All Purpose 428-430
 - Bathroom 431
 - Bleach 429, 438
 - Bleach Germicidal 466
 - Carpet 446
 - Computer, Screen & Keyboard 69
 - Cream 425
 - Degreaser 425
 - Dish Soap 420, 421
 - Drain 425, 432
 - Floor 444
 - Glass 426, 428
 - Magic Eraser® 430
 - Marker Board 344
 - Multi-Surface 428-430
 - Stainless Steel 425
 - Urinal 432
- Cleaning Card - P.O.S.** 328
- Cleaning Cloths** 69, 423, 426
- Cleaning Supplies Caddy** 424
- Cleaning Wipes** 69, 423, 430
- Clear Laser/Inkjet Labels** 135
- Clipboards** 198, 199
- Clips, Clamps And Paper Fasteners** 234-236
- Clocks** 349
- Clorox® Wipes** 427
- Closed for Cleaning Sign** 444
- Clothing, High Visibility** 474
- Coat Hangers** 232
- Coat Hooks & Trees** 232, 598
- Coffee** 404, 405, 409
- Coffee Cups** 411
- Coffee Filters** 408
- Coffee Maker Descaler** 403
- Coffee Makers** 403, 408
- Coffee Tables** 604, 605
- Coffee-Mate®** 410
- Coin Batteries** 74
- Coin Envelopes** 321
- Coin Sorters & Wrappers** 325
- Cold Pack** 464
- Col-Erase® Pencils** 392
- Colour Coding Labels** 138
- Coloured Paper** 126, 127
- Coloured Pencils** ... 370, 371, 378, 379
- Colouring Book** 372
- Colouring Markers** 294, 298, 300, 301, 373-375
- Colouring Mats** 367
- Columnar Books** 163
- Columnar Pads** 165
- Combination Locks** 498
- Combo Boards** 338, 339
- Comet®** 431
- Command Adhesive** 240
- Command Adhesive Hooks** ... 239, 240
- Command Adhesive Spray Bottle Hanger** 424
- Compass** 316

Composition Books	155-158		
Compostable Dinnerware	411, 412		
Compresses	461		
Computer Products & Accessories			
- Adapters	77, 78		
- Backrest	66		
- Cable Management	76		
- Cable Ties/Wrappers.....	76		
- Cables.....	76		
- CD Pockets	45		
- CD/DVD Storage	45		
- CDs	45		
- Charging Cables	76		
- Cleaner.....	69		
- Cleaning Cloths.....	69		
- Cleaning Wipes	69		
- CPU Holders.....	65		
- Displayport Cables	77		
- DVDs.....	45		
- Earbuds	86		
- Ethernet Cables.....	76		
- Extension Cords.....	70, 72		
- Flat Panel Filters	61		
- Footrests	67, 466		
- Hard Drives	46		
- HDMI Cables	77, 78		
- Headphones	85-87		
- Headset	87, 88		
- Keyboard/Mouse Combo	56-60		
- Keyboards	54-58		
- Laptop Cases	34-36		
- Laptop Sleeves	36		
- Laptop Stands	64, 65		
- Lightning Cables.....	76		
- Memory Card Reader	44		
- Memory Cards.....	44		
- Mice	47-50		
- Microphones	89		
- Monitor Arms & Stands	62-65		
- Monitor Cables	78		
- Monitors	61		
- Mouse Pads	51-53		
- Network Adapter	82		
- Optical Writer	45		
- Pocket Hub	79		
- Range Extender	82		
- Routers.....	81		
- Scanners	33		
- Sit Stand	551-553		
- Speakers.....	85		
- Stands	84		
- Streaming Lights	84		
- Stylus	286		
- Surge Protectors	70, 71		
- Switches.....	81		
- USB Cables.....	77, 78		
- USB Dock	80		
- USB Drives	42, 43		
- USB Pockets.....	42		
- Webcams.....	83, 84		
- Wireless Adapter.....	82		
- Wrist Rests.....	52, 53		
Cones	488		
Construction Paper	362		
Containers, Food	412, 414		
Conte Crayons	377		
Copier Labels	135		
Copy Paper	124-127		
Copyholders	68		
Cord Cover	76		
Cordless Sweeper	445		
Cork Boards	345, 346		
Corn Nuts	416		
Corners, Document	236		
Correction Products			
- Correction Film & Tape.....	289, 290		
- Correction Fluid.....	290		
Corrugated Paper Roll	363		
Cotton Balls	463		
Cotton Tipped Applicators	463		
Couch & Chair	542		
Counter, Tally	326		
Cover & Card Stock	126		
Cover Up Tape	290		
Coveralls	468		
Covers, Binding	115		
CPR Mask	465		
CPU Holders	65		
Craft Bags	364		
Craft Organizers	388		
Craft Sticks	365		
Craft Supplies	354-400		
Craft Supplies Caddy	372, 390		
Crayons	308, 372, 379		
Cream Cleaner	425		
Creamer	410		
Crepe Paper	363		
Crowd Control	504		
Cubby Bin	390		
Cups	411		
Cutlery	413		
Cutting Mats	354		
D			
Daily Appointment Books	143, 144		
Dare® Mints	417		
Data Binders	178		
Dawn®	421, 425		
Day-Timer®	151		
Debit Rolls	328		
Degreaser	425		
Delivery Receipt Forms	167		
Deodorizer, Carpet	446		
Depository	614		
Descaling Solution	403		
Desk & Wall Planners, Journals			
- Calendar Desk Pads	141, 150		
- Organizers	142, 151		
- Planner Refills.....	145, 146, 151		
- Planners.....	141, 145-149, 152		
- Teacher's Planner	142		
Desk Accessories			
- Bookends.....	223		
- Call Bell	253		
- Desk Pads.....	233		
- Desk Trays	224-229		
- Letter Opener	323		
- Organizers ...	203, 224-230, 232, 388		
- Paper Clip Dispenser.....	224, 227		
- Pencil Cups	224, 226, 227		
- Sorters	225, 226, 229, 230		
- Tape Dispensers	238		
- Telephone Stands	225		
Desk Grommets	598		
Desk Pad Calendars	141, 150		
Desk Pads	233		
Desk Planners	145-148, 152		
Desk Trays	224-229, 232		
Desks	557-592		

Desktop Files 203, 224

Dictation Equipment 89

Dictionaries & Thesaurus 393

Disc Writer 45

Dish Brush 422

Dish Soap 420, 421

Dishwand 422

Dishwasher Rinse Aid 420

Disinfecting Cleaner 428, 429

Disinfecting Spray 428, 429

Disinfecting Wipes 427

Dispensers

- Kraft Roll 511
- Note 249
- Paper Clip 224, 227
- Water 419

Display Boards 355

Display Racks, Literature 329, 330

Dissolvable Labels 137

Dividers 184, 185, 189

D-Link® Switches 81

Document Corners 236

Document Files 214

Document Frames 131, 331

Document Saver Bag 326

Document Saver Books 195

Document Seals 131, 323

Doilies 367

Door Hangers, Craft 367

Door Stops 479

Dot Matrix Printer Labels 136

Double Sided Tape 238, 496

Dowel 365

Drafting Chairs 537, 538

Drafting Supplies

- Blueprint Rack 222
- Compass 316
- Hanging Clamps & Racks 222
- Ink 387
- Protractors 316
- Storage Tubes 222
- Triangular Scales 316

Drafting Templates 316

Drain Cleaner 425, 432

Drawer Organizers 227

Drawers

- Cash 324
- File 218, 221

Drawing Ink 387

Drawing Paper 359, 360

Drawing Pencils 378

Drill 490

Drums

- Brother® 6, 7
- Fuzion® 23
- HP® 16
- Xerox® 22

Dry Erase Markers 342-344

Dry Erase Pockets 397

Dry Erase Surface 340

Dryer Sheets 438

Duct Tape 495, 496

Duffel Bags 40

Dust Cloths 439

Dust Mops 440

Dust Pans 441

Dusters 439

DVDs 45

Dymo® Label Printers 109-111

Dymo® Labels 109

E

Ear Muffs 470

Ear Plugs 470

Earbuds 86

Easels & Easel Pads 336, 347, 348, 356

Elastic Bandage 462

Elastics 236

Enclosed Boards 346

End Tab File Cabinets 609

End Tab Folders 206

Envelope Inserts 321

Envelope Sealer 323

Envelopes

- Bubble 320
- Business 317, 318
- Catalogue 319, 321
- CD/DVD 45

- Coin 321
- Expanding 212, 214
- Greeting Card 321
- Interoffice 322
- Invitation 129, 321
- Kraft 319, 321
- OP Brand 319
- Packing Slip 514
- Poly 210, 320, 322
- Security 317, 318
- Self Seal 317
- T4 318
- Tyvek 320
- Vinyl 198
- Window 317, 318

Epson® Inkjet Cartridges 13-15

Erasable Checking Pencil 392

Erasable Pens 282, 283

Erasers

- Magic Eraser® 430
- Pencil 306, 309
- Whiteboard 340, 341

Ergonomic Backrest 66

Ethernet Cables 76

Executive Pens & Sets 285

Exercise Books 159, 391

Expanding Envelopes 212, 214

Expanding File Pockets 206, 210, 211

Expanding Files 211-214, 229

Expanding Wallets 210-212

Expense Book 168

Extension Cords 70, 72, 489

Eye Wash 464, 469

Eyes, Wiggle 365

F

Fabric Boards 346

Fabric Protector 446

Fabric Refresher 438

Fabric Softener 438

Face Masks 467

Face Paint 367

Face Shield 468

Facial Tissue	433	File Sorters	209, 225, 229, 230	Filters	
Facility Equipment		File Totes	217	- Coffee.....	408
- Hand Trucks.....	501	Files		- Flat Panel.....	61
- Ladders.....	499	- Archboard.....	199	Financial Calculators	106
- Pallet Trucks.....	500	- Expanding.....	211-214, 229	Fine Paper	129
- Platform Trucks.....	501	- Magazine.....	223, 224, 226	Fineline Markers	298, 300, 301
- Rolling Ladders.....	500	- Wall.....	214, 224, 231	Finger Paint Paper	357
- Shovels.....	487	Filing & File Storage		Finger Paint Tray	381
- Step Stools.....	499	- Archboard Files.....	199	Finger Tips	323
- Tarps.....	488	- Box Files.....	202	Fire Extinguishers	475
- Tools.....	489-494	- Business Card Files.....	254-256	Fire Resistant Bag	326
- Wheel Chocks.....	500	- Business Card Holders.....	254, 255	Fire Resistant File Cabinets	611
Fans	476	- Card File Boxes.....	257	First Aid Kit	459
Fantastik®	429	- Card Guides.....	257	First Aid Supplies	459-465, 469
Fastener Guns & Supplies	327	- Classification Folders.....	207	Fixative	377
Fasteners		- Desktop.....	203, 224	Flags	
- Brass.....	236	- Document Files.....	214	- Canada.....	393, 486
- Hook & Loop.....	240, 327	- Expanding Files.....	211-214, 229	- Map.....	345
- Paper.....	236	- File Boxes.....	215-221	- Post-it®.....	250, 251
- Stick On.....	236	- File Cabinets.....	568, 608-612	Flash Drives	42, 43
- Tag.....	507	- File Cards.....	256	Flashlights	491
Fax Machines	25, 27, 28, 31, 32	- File Drawers.....	218, 221	Flat Panel Filters	61
Fax Paper	328	- File Folders.....	182, 194, 204-207	Flexible Planners	141
Feathers	366	- File Guides.....	208	Flip Chart Pads	348
Febreze®	438	- File Jackets.....	210	Flipchart Markers	348
Felt	364, 366	- File Pockets.....	202, 206, 210, 211, 257	Floor & Deck Brush	442
Felt Pads	479	- Hanging File Organizer.....	213	Floor Cleaner	440, 443, 444
Felt Pouch	214, 326	- Hanging Folder Frames.....	203	Floor Mats	478, 479
Fibre Tip Pens	300, 301	- Hanging Folders.....	201, 202	Foam Sheets	364
Figuring Pads	161, 162	- Index Cards.....	257	Foamboard	355
Filament Tape	495	- Index Dividers.....	185	Foil Wrap	415
File Boxes	215-217, 219-221	- Index Tabs.....	190, 208, 251	Fold Back Clips	235
File Cabinets		- Magazine Files.....	223, 224, 226	Folder Frames, Hanging	203
- End Tab.....	609	- Poly Folders.....	205	Folders	
- Fire Resistant.....	611	- Portable File Boxes.....	215	- Classification.....	207
- Lateral.....	609, 610	- Portable Files.....	215	- End Tab.....	206
- Pedestal File.....	609, 612	- Roll Storage Stand.....	220	- File.....	182, 194, 204-207
- Vertical.....	608, 609	- Shelf Folder Labels.....	208	- Hanging.....	201, 202
File Cards	256	- Shelf Folders.....	206	- Poly.....	205
File Carts	218	- Storage Boxes.....	215, 216	- Shelf.....	206
File Drawers	218, 221	- Storage Cabinets.....	613	- View.....	195
File Folders	182, 194, 204-207	- Tabs & Inserts.....	190, 203	Folding Chairs	535, 603
File Guides	208	- Totes.....	217	Folding Tables	603
File Jackets	210	- Transfer Cases.....	222	Follower Blocks	609
File Pockets ...	202, 206, 210, 211, 257	- View Folders.....	195		
		- Wall Files.....	214, 224, 231		
		Filing Labels	137, 209		

Food Containers 412, 414
Food Film415
Footrests..... 67, 466
Fountain Pen Ink 288, 386
Fountain Pens286
Fragile Labels508
Frames, Document..... 131, 331
Freezer Bags415
Fruit Crisps.....416
Fun Tak241
Funnel.....424
Furniture
 - Bookcases 568, 596, 597
 - Buffet Carts600
 - Chairmats548, 549
 - Chairs518-544
 - Desks557-592
 - Folding Chairs535, 603
 - Gaming 544
 - L Workstations567-584
 - Lecturns600
 - Lockers505
 - Machine Stands599
 - Modular Seating540
 - Multimedia Carts600
 - Multi-Person Workstations . .580-583
 - Pedestals612
 - Printer Stands599
 - Privacy Panels593-595
 - Reception 588-592, 604, 605
 - Reception Seating539, 542
 - Serving Carts600
 - Sit Stand
554, 555, 557, 574, 579, 584, 586
 - Stools538, 543
 - Storage Cabinets612, 613
 - Tables . .543, 553, 584, 587, 600-605
 - U Workstations559-566
 - Wardrobe557, 569, 612
Furniture Pads..... 479, 488
Furniture Polish439
Fuzion® Drums.....23
Fuzion® Inkjet Cartridges24
Fuzion® Toner23, 24

G
Gaming Chairs544
Gaming Desk544
Garage Repair Forms168
Garbage Bags 484, 485
Garbage Cans.....480-483
Garbage Grabber441
Garden Hose489
Gel Pens 277-285, 298
Germ Buster®.....458
Germ Buster® Wipes.....427
Gesso.....356
GHS Labels136
Gift Certificates.....131
Glad® Bags415
Glad® Wrap.....415
Glass Boards334-337
Glass Cleaner 426, 428
Glasses, Safety469
Glitter367
Gloves471-474
Glue
 - Crazy®243
 - Multi-Purpose . . .242, 243, 368, 496
 - Roller242
 - School242
 - Sticks241, 243, 368
 - Wood496
Glue Guns242
Golf Pencils.....308
Goo Gone242
Gorilla Tape495
Graphic Art Tape341
Grease.....490
Green Works®.....430
Greeting Card Envelopes.....321
Greeting Cards.....132
Grommets598
Guest Books253
Guest Chairs.....534-538
Guides, Card.....257

H
Hacksaw490
Hair Nets.....468
Hammer492
Hand & Nail Brush455
Hand Cleaner.....455
Hand Dryers437
Hand Sanitizer456-458
Hand Soap & Dispensers454-456
Hand Trucks & Carts
 - Hand Trucks501
 - Mail Carts506
 - Platform Truck501
 - Utility Cart501
Hand Warmer473
Hang Tabs.....241
Hanging Box Files.....202
Hanging Clamps & Racks.....222
Hanging File Organizer213
Hanging Folder Frames203
Hanging Folders 201, 202
Hard Drives46
Hard Hats474
HDMI Cables.....77, 78
Headphones.....85-87
Headsets.....87-90
Health & Safety
 - Air Horn488
 - Alcohol Swabs463
 - Antiseptic Swabs463
 - Applicators463
 - Apron468
 - Bandage Scissors462
 - Bandages460-462
 - Biowaste Container462
 - Blanket465
 - Bleach Germicidal Cleaner466
 - Blood Pressure Monitor466
 - Body Lotion455
 - Bouffant Caps468
 - Burn Gel Pack459, 463
 - Caution Tape496
 - Cold Pack464
 - Compresses461
 - Cotton Balls463

Health & Safety cont'd

- Coveralls.....468
- CPR Mask.....465
- Ear Muffs.....470
- Ear Plugs.....470
- Elastic Bandage.....462
- Eye Wash.....464, 469
- Fire Extinguishers.....475
- First Aid Kit.....459
- Gloves.....471-474
- Hair Nets.....468
- Hand Sanitizer.....456-458
- Hard Hats.....474
- High Visibility Clothing.....474
- Hot/Cold Pack.....79, 464
- Hydrogen Peroxide.....463
- Insect Repellent.....485
- Lens Cleaner.....469
- Medical Tape.....461
- Ointment.....463, 464
- Over the Bed Table.....466
- Pain Reliever.....464
- Particulate Masks.....467
- Rubbing Alcohol.....463
- Safety Cones.....444, 488
- Safety Glasses.....469
- Safety Kits.....459, 460
- Safety Tread.....499
- Salt Bin.....486
- Shoe Covers.....468
- Smoke & Carbon Monoxide Sensor.....475
- Stretcher.....465
- Sunscreen.....455
- Thermometer.....466
- Tongue Depressors.....463
- Tweezers.....462
- Healthcare Supplies..... 461-463, 466**
- Heaters.....477**
- Hex Keys.....492**
- High Visibility Clothing.....474**
- Highlighters.....291-293**
- Honey.....410**
- Hoodies, High Visibility.....474**
- Hook & Loop Fasteners..... 240, 327**
- Hooks**
 - Adhesive.....239, 240
 - Drywall Claw.....240
 - Suction Cup.....257
- Hose.....489**
- Hot Chocolate.....406**

- Hot Pack..... 79, 464**
- HP® Drums.....16**
- HP® Inkjet Cartridges.....17-19**
- HP® Toner.....15-17**
- Hubs.....79**
- Humidifiers.....450**
- Hydrogen Peroxide.....463**

I

- Ice Melt.....486**
- Ice Pack.....464**
- ID Holder.....140**
- ID Labels.....136**
- In/Out Boards.....252**
- Index Cards.....257**
- Index Dividers.....184, 185, 189**
- Index Tabs.....190, 208**
- Indexes**
 - Alphabetical.....188
 - Clear View.....187
 - Colour Coded.....186
 - Insertable...182, 184, 185, 188, 189
 - Laser/Inkjet.....184, 186, 187
 - Legal.....188, 189
 - Numbered.....188
 - Printed Tab.....188, 189
 - Write On.....184
- Ink**
 - Calligraphy.....386
 - Drawing.....387
 - Fountain Pen.....288
- Ink Rollers**
 - Calculator/Cash Register.....23
 - Price Gun.....327
- Inkjet Cartridges**
 - Brother®.....7-10
 - Canon®.....11-12
 - Epson®.....13-15
 - Fuzion®.....24
 - HP®.....17-19
- Inkjet Labels.....138**
- Inkjet Printers.....31, 32**
- Inkjet Refill - Canon®.....31, 32**
- Insect Repellent.....485**
- Insecticide.....485**
- Inspection Log Book.....168**

- Instant Coffee.....409**
- Interoffice Envelopes.....322**
- Interoffice Memo Forms.....167**
- Invitation Envelopes.....129, 321**
- Invoice Forms.....167**

J

- Jackets - File.....210**
- Janitorial Equipment**
 - Brooms.....440, 441
 - Buckets.....424, 443
 - Carpet Cleaner.....446
 - Carry Caddy.....424
 - Carts.....444
 - Closed for Cleaning Sign.....444
 - Dust Mops.....440
 - Dust Pans.....441
 - Extension Cords.....489
 - Squeegee.....426
 - Sweeping Compound.....441
 - Toilet Plunger.....431
 - Vacuums.....445, 446
 - Wet Floor Sign.....444
 - Wet Mops.....440, 442, 443
- Janitorial Supplies**
 - Air Freshener.....451, 452
 - Bleach.....429, 438
 - Bottle Scrubber.....422
 - Bug Killer.....485
 - Carpet Cleaner.....446
 - Carpet Deodorizer.....446
 - Chix Towels.....423
 - Cleaner, All Purpose.....428-430
 - Cleaner, Bathroom.....431
 - Cleaner, Cream.....425
 - Cleaner, Degreaser.....425
 - Cleaner, Glass.....426, 428
 - Cleaner, Magic Eraser®.....430
 - Cleaner, Multi-Surface.....428, 430
 - Cleaner, Powder.....431
 - Cleaner, Urinal.....432
 - Cleaning Cloths.....423, 426
 - Dish Brush.....422
 - Dish Soap.....420, 421
 - Dishwand.....422
 - Disinfectant.....427-429
 - Disinfecting Wipes.....427
 - Drain Cleaner.....425, 432
 - Dryer Sheets.....438

Janitorial Supplies cont'd

- Dust Cloths 439
- Dusters 439
- Eraser Sponge 430
- Fabric Refresher 438
- Fabric Softener 438
- Facial Tissue 433
- Floor Cleaner 440, 443, 444
- Funnel 424
- Furniture Pad 488
- Furniture Polish 439
- Garbage Bags 484, 485
- Hand & Nail Brush 455
- Hand Cleaner 455
- Hand Soap 454-456
- Ice Melt 486
- Lane Marking Tape 496
- Laundry Soap 438
- Lint Roller 438
- Paper Towels 436, 437
- Sanitizer 429, 458
- Scotchgard™ 446
- Scouring Pads 422
- Scrub Brush 424, 431, 442
- Soap Pads 422
- Sponges 422
- Spray Bottles 424
- Stain Remover 438
- Stainless Steel Cleaner 425
- Sweeper 445
- Toilet Bowl Cleaner 431, 432
- Toilet Paper & Dispensers ... 434, 435
- Toilet Seat Covers & Dispenser ... 435
- Towel Dispenser 436, 437
- Upholstery Cleaner 446
- Urinal Pucks 432
- Wipes 423, 430

- Jewel Cases 45**
- Jewelry Tags 327**
- Journals 158**

K

- K Cup Storage 403**
- K Cups 404-407**
- Kettle 408**
- Keurig® Coffee Maker 403**
- Key Cabinets, Rings & Tags 497**
- Key Safe 497**

- Key Tags 497**
- Keyboard Trays 59, 60**
- Keyboard/Mouse Combo 56-58**
- Keyboards 54-58**
- Kind® Bars 416**
- Knife Blades 354, 493, 494**
- Knives**
 - Arts & Craft 354
 - Paint 384
 - Utility 493, 494
- Knives, Forks & Spoons 413**
- Kraft Envelopes 319, 321**
- Kraft Paper Roll 363**
- Kraft Roll Dispenser 511**
- Kraft Wrap 511**
- Krazy® Glue 243**

L

- Label Printer Adapters 110, 112**
- Label Printer Labels 109, 111**
- Label Printer Tape 110, 113**
- Label Printers 109-112**
- Labels**
 - Arched 137
 - Brother® Die Cut 111
 - Brown Kraft 137
 - CD 45
 - Clear Laser/Inkjet 135
 - Colour Coding 138
 - Continuous Tape 111
 - Copier 135
 - Dissolvable 137
 - Dot Matrix 136
 - Eco Friendly 134
 - Filing 137, 209
 - GHS 136
 - Glossy 135, 137
 - Gold Foil 137
 - Hemp 137
 - High Visibility 136, 138
 - Label Printer 109
 - Laser 134
 - Laser ID 136
 - Laser/Inkjet 134
 - Laser/Inkjet ID 136
 - Lid Seal 137
 - Matte 137

- Numeric 208
- Oval 137
- Pearlized 137
- Preprinted 208, 508
- Pricing 327
- Rectangular 137
- Removable 136, 138
- Removable Vinyl 138
- Round 137, 138
- Shelf Filing 208
- Shipping 111, 134, 135, 508
- Silver Embossed 137
- Square 137
- Static Cling 138
- Thermal 135
- Wraparound 137
- Year 208

- Ladders 499, 500**
- Laminating Pouches 119, 120, 140, 331**
- Laminating Rolls 119, 120**
- Laminator Cleaning Sheets 120**
- Laminators 117, 118**
- Lamps 350-352**
- Lamps - Streaming Lights 84**
- Lane Marking Tape 496**
- Lanyards 140**
- Lap Desk, Children's 389**
- Laptop Cases 34-38**
- Laptop Sleeves 36**
- Laptop Stands 64, 65**
- Laser ID Labels 136**
- Laser Labels 134**
- Laser Pointers 93**
- Laser Printers 25-30**
- Laser/Inkjet Labels 134, 135**
- Lateral File Cabinets 609, 610**
- Laundry Marker 302**
- Laundry Soap 438**
- LCD Monitor 61**
- Leads & Lead Holders 306**
- Lecturns 600**
- LED Signs 333**
- Ledger Outfits 164**
- Ledger Sheets 164**
- Ledger Size Binders 179**
- Legal Indexes 188**

- Legal Size Binders**.....179
- Lens Cleaner**469
- Letter Opener**323
- Letter Trays** ... 224-226, 228, 229, 232
- Letterhead**.....129
- Lettering, Stick On**354
- Level**490
- Lexmark® Toner**..... 19-21
- Library Card Pockets**.....399
- Licorice**417
- Lifesavers®**417
- Light Stand**84
- Lightning Cables**.....76
- Lint Roller**.....438
- Liquid-Plumr®**425
- Literature Box**330
- Literature Sorters & Organizers**
 - Literature Display Racks.....329
 - Literature Holders.....330
 - Literature Organizers223, 389
 - Magazine Racks329
 - Sorters223
- Locker Room Bench**505
- Lockers**505
- Locks**
 - Combination498
 - Luggage.....498
 - Padlock.....498
- Log Books**
 - Inspection168
 - Password252
 - Voice Mail252
- Looseleaf Rings**.....235
- Lubricant**490
- Luggage**39, 40
- Luggage Cart**39
- Luggage Locks**.....498
- Luggage Tags**.....40
- Lumber Crayons**308
- Lumocolor® Pens**.....300
- Lunch Bags**.....40
- Lysol®**429
- Lysol® All Purpose Cleaner**429
- Lysol® Wipes**.....427

M

- Machine Stands**.....599
- Machines**
 - Binding114
 - Calculator.....102, 103
 - Laminators117, 118
 - Multifunction Printers25-32
- Made in Canada Labels**508
- Magazine Files**223, 224, 226
- Magazine Holder**.....223
- Magazine Racks**329
- Magic Eraser®**430
- Magnetic Business Cards**.....256
- Magnetic Clips**.....235
- Magnetic Marker Holder**..... 340, 341
- Magnetic Sheets**.....132
- Magnetic Stripping**341
- Magnets**.....341
- Magnifier Lamps**.....350
- Magnifiers**255
- Mail Carts**.....506
- Mailing & Shipping Supplies**
 - Air Pillows511
 - Bubble Wrap511
 - Cardboard Boxes.....510
 - Envelope Sealer323
 - Envelopes.....129, 317-321
 - Knives.....493, 494
 - Kraft Roll Dispenser511
 - Mailers.....320, 321, 509
 - Mailing Tubes508
 - Packing Slip Envelopes.....514
 - Postal Scales506
 - Shipping Scales.....506
 - Strapping.....510
 - Stretch Wrap512
 - Tags327, 507
 - Tape495, 513, 514
 - Wrapping Paper511
- Map Flags**.....345
- Map Pins**.....345
- Marker Board Cleaner**344
- Marker Board Markers**.....342-344
- Marker Boards**.....334-338, 347
- Marker Paper**.....360

Markers

- Art.....374
- Berol®.....296
- BIC®296
- Bingo Daubers.....375
- Calligraphy300, 375, 386
- Chalk302
- China302
- Colouring
 -294, 298, 300, 301, 373-375
- Dry Erase342-344
- Erasable283, 373
- Finesline298-301
- Flipchart.....348
- Laundry302
- Lumocolor®.....296
- Marks-a-lot®.....296
- Metallic.....297
- Mr. Sketch®373
- OP Brand294
- Paint.....297
- Permanent...294-298, 302, 343, 374
- Pilot®296
- Reach302
- Redacting302
- Redimark®.....295
- Refillable295, 343
- Sharpie®.....294-2987, 374
- Sharpie® Paint.....297
- Twin Tip294
- Universal Lumocolor®300
- Washable.....373
- Wet Erase.....301
- White302
- Window374

- Marking Tags**..... 132, 327
- Masking Tape**.....495
- Masks**
 - Face467
 - Particulate.....467
- Math & Geometry Sets**.....394
- Mats**
 - Anti-Fatigue478, 479, 556
 - Floor.....478
- Mechanical Pencils**..... 304, 305
- Medical Tape**461
- Memo Books**155, 157, 160
- Memory Card Reader**44
- Memory Cards**.....44

Message Book252
 Message Pads252
 Message Spike252
 Metal Rim Tags497
 Metallic Markers297
 Metric Conversion Calculators106
 Mice47-50
 Microban® 24429, 431
 Microphone Stand84
 Microphones89
 Microwaves419
 Milk410
 Mirrors504
 Mixed Media Paper359
 Mobile Desk553
 Modelling Clay369
 Modular Seating540
 Moisteners & Sponges323
 Moisturizer455
 Monitor Arms & Stands62-65
 Monitor Filter61
 Monitor Risers64, 65
 Monitors61
 Monthly Appointment Books. 147, 148
 Mops440, 442, 443
 Mounting Tape241
 Mouse Pads51-53
 Mr. Clean® Magic Eraser®430
 Mr. Clean® Multi-Surface428, 430
 Mr. Clean® Pro Floor Cleaner444
 Multi Tilter Chairs518-525
 Multimedia Carts600
 Multimedia Projectors92
 Multi-Purpose Glue 242, 243, 368, 496
 Multi-Purpose Paper124-127
 Multi-Surface Cleaner428, 430
 Mural Rolls363

N

Nail Brush455
 Name Badges139, 140
 Name Plates - Classroom397

Name Plates - Cubicle232
 Name Tags for Children398
 Napkins414
 Neon Labels136
 Network Adapters82
 Newsprint Pad360
 No More Nails® Adhesive496
 Note Dispensers249
 Notebooks154-160
 Notecards129, 132
 Notes
 - Pop Up249
 - Stick On245-249, 348
 Numeric Labels208
 Nut Bars416
 Nuts417

O

OFF®485
 Oil - Shredder100
 Oil & Acrylic Paper357
 Oil Paint382
 Oil-Shredder100
 Ointment463, 464
 OP Brand
 - Binders176, 177
 - Binding Cases222
 - Calculators105, 106
 - Correction Tape289
 - Dry Erase Markers342
 - Envelopes319
 - Figuring Pads161
 - File Boxes219, 220
 - File Folders204
 - Filing Tabs203
 - Foldback Clips235
 - Glue Sticks243
 - Hanging Folders201
 - Highlighters291
 - Indexes185-187
 - Labels134
 - Laminating Pouches119
 - Markers294
 - Notebooks154, 157
 - Page Holders196
 - Paper Clips234

- Paper Punch266
 - Pencil Sharpener311
 - Pencils308
 - Pens274
 - Rubber Bands236
 - Scissors314
 - Staplers259, 261
 - Staples265
 - Tape237

Opener, Letter323
 Operator Chairs530, 537
 Organizer Refills151
 Organizers
 - Craft388
 - Dated151
 - Desk203, 224-232, 388
 - Drawer227
 - Literature223, 389
 - Perpetual142

Outdoor Literature Box330
 Outlets72
 Overhead Transparencies93
 Overlay Binders175, 176, 179
 Oxivir® Wipes427

P

Packaging Tape Dispensers514
 Packing Slip Envelope514
 Padded Envelopes320
 Padding Board321
 Padfolios & Portfolios41, 198
 Padlocks498
 Pads
 - Analysis165
 - Columnar165
 - Desk233
 - Figuring161, 162
 - Flip Chart348
 Page Holders
 - Card Collector Sheets181
 - Photo181
 - Sheet45, 196, 197, 257
 Page Markers251
 Page Protectors181, 196, 197, 257
 Pails424, 443
 Pain Reliever464

Paint			
- Acrylic	383		
- Face	367		
- Oil	382		
- Tempera	380		
- Washable	380, 381		
- Watercolour	382		
Paint & Lettering Stencils	354		
Paint Brushes	381, 385, 492		
Paint Bucket	385		
Paint Cups	380		
Paint Knives	384		
Paint Markers	297		
Paint Palettes	380, 384		
Paint Tray	381		
Painter's Tape	495		
Pallet Trucks	500		
Pallet Wrap	512		
Panel Accessories			
- Clip	232		
- Coat Hooks	232		
- File Pocket	232		
- Hanging File	232		
- Name Plates	232		
- Triple Desk Tray	232		
- Triple File	232		
Paper			
- Binder Paper	181		
- Canvas	356		
- Carbon Paper	168		
- Card & Cover Stock	126		
- Coloured	126, 127		
- Construction	362		
- Fax	328		
- Finger Paint	357		
- Marker	357, 360		
- Mixed Media	359		
- Multi-Purpose	124-127		
- Oil & Acrylic	357		
- Pastel	359, 360		
- Pen & Ink	360		
- Photo	128		
- Specialty Papers, Fine	129		
- Watercolour	357		
- Wide Format	127		
- Wrapping	511		
Paper Bags	327		
Paper Chalk	376		
Paper Clamps	235		
Paper Clip Dispenser	224, 227		
Paper Clips	234		
Paper Cups	411		
Paper Fastener	236		
Paper Punches	266-268		
Paper Rolls	328		
Paper Rolls, Art & Craft	363		
Paper Stumps	377		
Paper Tape	514		
Paper Towel Dispenser	436, 437		
Paper Towels	436, 437		
Paper Trimmers	313		
Particulate Masks	467		
Partition Accessories	232		
Parts Bins	502		
Password Log Book	252		
Pastel Paper	359, 360		
Pastels - Chalk	376		
Pastels - Oil	376		
Pastels - Soft	376		
Payroll Books	165		
Payroll Statements	165		
Pedestals	557, 559, 563-566, 570-576, 580, 583, 589		
Pen & Ink Paper	360		
Pen Cleaner	386		
Pencil Cases	309, 371, 389		
Pencil Crayons	370, 371, 378, 379		
Pencil Cups	224, 226, 227		
Pencil Grips	309		
Pencil Sets, Art	378, 379		
Pencil Sharpeners	311, 312, 371		
Pencils			
- Checking	392		
- Colouring	370, 371, 378, 379		
- Golf	308		
- Mechanical	304, 305		
- Primary	308		
- Woodcase	308, 392		
Pens & Refills			
- Art Pens	386		
- Erasable Pens	283		
- Executive, Pen/Pencil Sets	285		
- Fibre Tip	300, 301		
- Fountain Pens	286		
- Gel Pens	277-280, 282, 283, 285, 298		
- Pen Refills	253, 273, 285-288		
- Retractable Pens	270-273, 277, 278, 280, 283, 285		
- Roller Pens	272, 274, 277, 282-284		
- Security Pens	253		
- Stick Pens	273-275, 282		
Perfed Pads	161, 162		
Permanent Markers	294-298, 302, 343, 374		
Peroxide	463		
Perpetual Appointment Books	142		
Personal Protection Equipment			
- Barriers	593		
- Face Masks	467		
- Face Shield	468		
- Gloves	471-474		
- Safety Glasses	469		
Personnel Boards	252		
Pest Control	485		
Phones	88, 90		
Photo Page Holders	181		
Photo Paper	128		
Picture Hangers	240		
Pilot® Markers	296		
Pine-Sol®	428, 430		
Pipe Cleaners	366		
Pitcher	412		
Place Cards	129		
Planner Refills	145, 146		
Planners			
- Academic	152		
- Desk	142-148, 152		
- Flexible	141		
- Teacher	142		
- Wall	141, 149		
Plans Storage Stand	222		
Plastic Wrap	415		
Plates	412		
Platform Truck	501		
Playhouse	395		
Pledge®	425, 428, 430, 439		
Plier Staplers	264		
Pliers	492		
Plotter Paper	127		

Plunger431

Pocket Mask465

Pockets

- Binder.....182
- CD.....45
- Dry Erase.....397
- File.....202, 206, 210, 211, 257
- Library.....399
- USB.....42

Podiums600

Pointers93

Polish, Furniture439

Poly Envelopes210, 320, 322

Poly Folders205

Pom Poms365

Pop Up Note Dispensers.....249

Pop Up Notes249

Posside Sticks365

Portable Files.....215

Portfolios & Padfolios41, 198

Portfolios & Report Covers191-195

Postage Meter Ink23

Postal Scales506

Poster Board355

Poster Tape238

Post-it® Flags.....250, 251

Post-it® Index Tabs.....190, 208, 251

Post-it® Note Dispensers.....249

Post-it® Notes245-249, 348

Post-it® Page Markers251

Post-it® Pop Up Notes249

Pouches, Binder182

Pound Bags507

Power Adapters.....40

Preprinted Labels.....208, 508

PRES-a-ply® Labels.....134

Presentation Binders.....178

Presentation Books355

Presenter - Wireless93

Price Guns.....327

Price Labels327

Primary Pencils.....308

Printer Stands.....599

Printers - Inkjet.....31, 32

Printers - Laser25-30

Printers - Multifunction.....25-32

Privacy Filter61

Privacy Panels593-595

Privacy Screen594

Project Display Board.....355

Projection Screens93

Projectors, Multimedia92

Protective Clothing468

Protective Vinyl.....120

Protectors, Surge70, 71

Protractors.....316

Pry Bar490

P-Touch® Label Printers.....111, 112

Pumice Hand Cleaner.....455

Punches266-268

Purchase Order Forms167

Purell®.....456-458

Purex®.....438

Push Pins345

R

Racks, Magazine329

Radio, Two Way.....488

Raid®.....485

Range Extenders.....82

Receipt Books166

Reception Accessories253

Reception Furniture.....588-592

Reception Seating539, 542

Reception Tables.....604, 605

Rechargeable Batteries.....74

Record Books.....168

Recorders, Dictation.....89

Recycling Containers481-483

Redacting Markers302

Reel Clips139

Refills

- Academic Calendar.....152
- Binder Paper.....181
- Calendar Pad.....150
- Pen.....288
- Planner.....145, 146, 151

Refrigerators418

Reinforcements.....181

Removable Labels136, 138

Report Cover Spines192

Report Covers & Portfolios191-195

Requisition Forms.....167

Restaurant Checks166

Retractable Pens....270-273, 277-285

Ribbons

- Oki®.....22, 24
- Time Clock.....121
- Universal Calculator.....23

Ring Binders41, 175-179

Rings, Loose Leaf235

Rinse Aid.....420

Roloids417

Roll Storage Stand220

Roller Pens....272, 274, 277, 282-284

Rolling Ladders.....500

Rolodex Cards & Files.....256

Round Head Fasteners.....236

Routers.....81

Rubber Bands236

Rubber Cement.....242

Rubber Mallet492

Rubbing Alcohol463

Rulers316, 394

S

S.O.S.® Pads422

Safes324, 497, 611, 614, 615

Safety Clothing, High Visibility474

Safety Cones444, 488

Safety Glasses469

Safety Kits459, 460

Safety Tread.....499

Safety Vests474

Sales Forms166

Sales Order Forms.....167

Salesman Cases.....39

Salt, Ice Melt486

Salt & Pepper.....412

- Salt Bin**486
- Samsung® Toner**22, 24
- Sandwich Bags**415
- Sanitary Napkin Disposal**435
- Sanitizer**
- Hand456-458
 - Surface428, 429, 458
- Scales**
- Postal506
 - Shipping506
 - Triangular316
- Scanners**33
- Scented Markers**373
- School Glue**242, 368
- Scientific Calculators**107
- Scissors**314, 315, 395
- Scissors, Bandage**462
- Scotchgard™**446
- Scouring Pads**422
- Scrapbooks**361
- Scraper**493
- Scratch Pads**161
- Screen Cleaner**69
- Screens**
- Privacy594
 - Projection93
- Screwdrivers**492
- Scrub Brush**424, 431, 442
- Scrubbing Bubbles®**
- Bathroom Cleaner**431
- SD Cards**44
- Seals**131, 323
- Seat Cushion**66, 579
- Security Badge Holder**139
- Security Envelopes**317, 318
- Security Mirrors**504
- Security Pens**253
- Security Receipt Forms**166
- Security Wristbands**140
- Self Seal Envelopes**317
- Self-Adhesive Laminating Pouches** 120
- Sentence Strips**398
- Serving Carts**600
- Sharpie® Markers**294-298, 374
- Sharpie® Pens**300
- Sheet Holders**198
- Sheet Protectors**... 196, 197, 257, 331
- Shelf Folder Labels**208
- Shelf Folders**206
- Shelving**502, 503
- Shipping Labels**... 111, 134, 135, 508
- Shipping Scales**506
- Shipping Tags**327, 507
- Shirts, High Visibility**474
- Shoe Covers**468
- Shopping Bags**327
- Shovels**487
- Shredder Bags**100
- Shredder Oil**100
- Shredders**95-100
- Shrink Wrap**512
- Sidewalk Chalk**396
- Sign Holders**232, 329-331
- Signs**
- Business Hours332, 333
 - Closed for Cleaning444
 - LED333
 - Wet Floor444
- Signs & Decals**329-333, 444, 475
- Sit Stand Convertors**551-553
- Sit Stand Mats**548
- Sit Stand Tables**
-553-555, 557, 574, 579, 584, 586
- Sketch Books**358, 359
- Sketching Pens**386
- Skid Wrap**512
- Small Page Binders**179
- Smock, Children's**381
- Smoke & Carbon Monoxide**
- Detector**475
- Smoking Receptacle**483
- Snacks**416, 417
- Snow Brush**486
- Soap & Dispensers**454-456
- Soap Pads**422
- Sofa & Chair**542
- Sorters**
- Coin325
 - Desk230
 - File209, 225, 226, 229, 230
 - Literature223
- Soup**416
- Spade**487
- Speakers**85
- Spic and Span®**444
- Spines, Report Cover**192
- Splenda®**410
- Sponges**422
- Spray Adhesive**241
- Spray Bottle Hanger**424
- Spray Bottles**424
- Squeegee**426
- Stacking Chairs**535, 536
- Stain Remover**438
- Stainless Steel Cleaner**425
- Stamps, Pads & Inkers** ... 170-173, 393
- Stands, Machine**599
- Staple Guns**489
- Staple Removers**264
- Staplers, Staples, & Removers**
- Battery/Electric Staplers264
 - Desktop Staplers259-263
 - Heavy Duty Staplers... 261, 263, 264
 - Plier Staplers264
 - Standup Staplers261, 262
 - Staple Gun489
 - Staple Removers264
 - Staples260, 263, 265, 489
- Statement Forms**167
- Statements, Payroll**165
- Steel Bookcases**597
- Stencils**354
- Steno Books**160
- Step Stools**499
- Stepladders**499
- Stick On Notes**245-249, 348
- Stick Pens**273-275, 282
- Stickers**399, 400
- Stick-on Fasteners**236
- Sticky Tack**241
- Stir Sticks**411

- Stools** 538, 543
Stop Watch 349
Storage Bags 414, 415
Storage Bins 390
Storage Boxes . 215, 216, 223, 389, 390
Storage Cabinets
 571, 584, 597, 601, 612, 613
Storage Tubes 222, 508
Strapping 510
Straws 413
Streaming Lights 84
Stretch Wrap 512
Stretcher 465
String 507
Student Recognition Awards 399
Stylus 286
Styrofoam 367
Suction Cup Hooks 257
Sugar 410
Sunscreen 455
Surge Protectors 70, 71
Sweeper 445
Sweeping Compound 441
Sweetener 410
Swiffer® Dusters 439
Swiffer® Sweeper 440, 443
Switch, Computer 81
Synchro Tilter Chairs 526, 527
- T**
- T4 Envelopes** 318
Table Desks 543
Tables
 - Bar Height 584, 604, 605
 - Boardroom 600, 601
 - Cafeteria 601, 605
 - Coffee 604, 605
 - Connecting 602, 603
 - Folding 603
 - Over the Bed 466
 - Sit Stand 553-555, 557, 574, 579, 584
 - Stacking 543
Tablet Accessories 286
Tags, Post-it® 190, 208, 251
- Tags & Inserts** 190, 203
Tag Fasteners 507
Tag Wire 507
Tags
 - Jewelry Tags 327
 - Marking 132, 327
 - Metal Rim 497
 - Shipping 327, 507
Tally Counter 326
Tape
 - Book 238
 - Box Sealing 513, 514
 - Caution 496
 - Double Sided 238, 496
 - Duct 495, 496
 - Filament 495
 - Gorilla 495
 - Graphic Art 341
 - Invisible 237
 - Label Printer 110, 113
 - Lane Marking 496
 - Masking 495
 - Mounting 241
 - OP Brand Invisible 237
 - Painter's 495
 - Paper 514
 - Permanent Mending 237
 - Poster 238
 - Strapping 513
 - Transparent 237
 - Vinyl 495
 - Wall Safe 237
Tape Dispensers 238, 514
Tape Guns 514
Tape Measure 489
Tarps 488
Task Chairs 533
Tassimo® 405
Tea 406, 407
Teacher's Planner 142
Telephone Accessories 89, 227
Telephone Address Books 253
Telephone Handset Lifter 88
Telephone Headsets 88-90
Telephone Message Books & Pads .. 252
Telephone Message Spike 252
Telephone Stands 225
- Telephones** 90
Tempera Paint 380
Templates, Drafting 316
Tent Cards 132
Thermal Labels 135
Thermal Rolls 328
Thermometers 466
Thesaurus 393
This Side Up Labels 508
Thread 366
Thumb Tacks 345
Tickets
 - Admission 326
 - Printable 326
Tide® 438
Tile & Grout Brush 431
Tilter Chairs 528-532
Time Clock & Accessories 121, 122
Time Sheet Forms 167
Tin Foil 415
Tissue, Facial 433
Tissue Paper 363
Toaster 418
Toaster Oven 418
Toilet Bowl Cleaner 431, 432
Toilet Paper & Dispensers 434, 435
Toilet Plunger 431
Toilet Seat Covers & Dispenser 435
Toner
 - Brother® 6, 7
 - Canon® 10
 - Fuzion® 23, 24
 - HP® 15-17
 - Lexmark® 19-21
 - Samsung® 22, 24
 - Xerox® 22, 24
Tongue Depressors 463
Tool Boxes 491
Tools
 - Drill 490
 - Extension Cords 72, 489
 - Grease 490
 - Hacksaw 490
 - Hammer 492
 - Hex Keys 492
 - Level 490

Tools cont'd

- Pliers.....492
- Pry Bar.....490
- Rubber Mallet.....492
- Scraper.....493
- Screwdrivers.....492
- Snow Brush.....486
- Staple Gun.....489
- Tape Measure.....489
- Vise-Grips.....492
- Wrenches.....490, 492
- Towel Dispenser..... 436, 437**
- Towels, Chix.....423**
- Toy Box.....395**
- Tracing Paper.....361**
- Transfer Cases.....222**
- Transfers, T Shirt.....132**
- Transparency Film.....93**
- Travel Adapters.....40**
- Trays, Desk.... 224-226, 228, 229, 232**
- Tread, Safety.....499**
- Triangular Scales.....316**
- T-Shirt Transfers.....132**
- Tubes, Mailing.....508**
- Tweezers.....462**
- Twin Tip Markers.....294**
- Twine.....507**
- Twinkle®.....425**
- Tylenol®.....464**
- Tyvek Envelopes.....320**

U

- Upholstery Cleaner.....446**
- Urinal Cleaner.....432**
- Urinal Pucks.....432**
- USB Cables.....77, 78**
- USB Dock.....80**
- USB Drives.....42, 43**
- USB Pockets.....42**
- Utensils.....413**
- Utility Carts.....501**

V

- Vacuums..... 445, 446**
- Varnish.....384**
- Velcro..... 76, 240, 327**
- Vertical File Cabinets.....568, 608, 609**
- Vests, High Visibility.....474**
- View Binders..... 175, 176**
- View Folders.....195**
- Vinyl Envelopes.....198**
- Vis-à-Vis Markers.....301**
- Vise-Grips.....492**
- Voice Mail Log Book.....252**
- Voice Recorders.....89**

W

- Walkie Talkie.....488**
- Wall Calendars.....149**
- Wall Files.....214, 224, 231**
- Wall Pad.....348**
- Wall Planners..... 141, 149**
- Wall Taps.....72**
- Wallets, Expanding.....210-212**
- Wardrobes..... 557, 566, 569, 612**
- Washable Markers.....373**
- Washable Paint..... 380, 381**
- Waste Receptacles**
 - Sanitary Napkin.....435
 - Smoking.....483
- Wastebaskets.....480-483**
- Water Activated Tape Dispenser.....514**
- Water Bottles.....412**
- Water Dispenser.....419**
- Watercolour Crayons.....379**
- Watercolour Paint.....382**
- Watercolour Paper.....357**
- Watercolour Pencils.....379**
- WD-40®.....490**
- Webcam Stand.....84**
- Webcams.....83, 84**
- Weekly Appointment Books...145-147**

- Werther's®.....417**
- Wet Floor Sign.....444**
- Wet Mops.....440, 442, 443**
- Wheel Chocks.....500**
- White Boards..... 338, 339**
- White Markers.....302**
- Whiteboard Eraser..... 340, 341**
- Whiteboard, Learn to Print.....391**
- Whiteboards..... 336-338, 347**
- Wide Format Paper.....127**
- Windex®..... 426, 428**
- Window Cleaner..... 426, 428**
- Window Envelopes..... 317, 318**
- Window Markers.....374**
- Window Washing Squeegee.....426**
- Windshield Washer Fluid.....486**
- Wipes, Cleaning..... 423, 430**
- Wireless Adapters.....82**
- Wireless Charging.....227, 351, 351**
- Wireless Charging Pad.....79**
- Wireless Presenter.....93**
- Wood Glue.....496**
- Woodcase Pencils..... 308, 392**
- Workstation Panel System.....594**
- Workstations.....554-592, 597, 601**
- Wrap, Bubble.....511**
- Wrapping Paper.....511**
- Wrenches..... 490, 492**
- Wrist Rests.....52, 53**
- Wristbands.....140**
- Writing Pads..... 161, 162**

X,Y,Z

- Xerox® Drums.....22**
- Xerox® Toner.....22, 24**
- Year Labels.....208**
- Ziploc® Bags..... 414, 415**
- Zipper Bags..... 322, 415, 415**
- Zippered Binders..... 41, 180**

LINKS
CONTRACT FURNITURE INC.



www.linkscontract.com

work from home

solutions for every space



Whether you're working from home or the office, your ergonomic needs haven't changed. The ideal work from home setup includes a number of components that work together to create an ecosystem that helps with neutral working postures, boosting productivity, and maintaining wellness.

Get ahead of your discomforts, injuries and burnout, contact your sales representative to help you build the perfect work from home solution for your space.

Officestogo

OFFICESTOGO.COM

100%  Canadian owned